

Fieldbus

Getting Started with Your AT-FBUS and the NI-FBUS™ Software

Worldwide Technical Support and Product Information

www.ni.com

National Instruments Corporate Headquarters

11500 North Mopac Expressway Austin, Texas 78759-3504 USA Tel: 512 794 0100

Worldwide Offices

Australia 03 9879 5166, Austria 0662 45 79 90 0, Belgium 02 757 00 20, Brazil 011 284 5011,
Canada (Calgary) 403 274 9391, Canada (Ontario) 905 785 0085, Canada (Québec) 514 694 8521,
China 0755 3904939, Denmark 45 76 26 00, Finland 09 725 725 11, France 01 48 14 24 24,
Germany 089 741 31 30, Greece 30 1 42 96 427, Hong Kong 2645 3186, India 91805275406,
Israel 03 6120092, Italy 02 413091, Japan 03 5472 2970, Korea 02 596 7456, Mexico (D.F.) 5 280 7625,
Mexico (Monterrey) 8 357 7695, Netherlands 0348 433466, New Zealand 09 914 0488, Norway 32 27 73 00,
Poland 0 22 528 94 06, Portugal 351 1 726 9011, Singapore 2265886, Spain 91 640 0085,
Sweden 08 587 895 00, Switzerland 056 200 51 51, Taiwan 02 2528 7227, United Kingdom 01635 523545

For further support information, see the *Technical Support Resources* appendix. To comment on the documentation, send e-mail to techpubs@ni.com

© Copyright 2000 National Instruments Corporation. All rights reserved.

Important Information

Warranty

The AT-FBUS and AT-FBUS/2 are warranted against defects in materials and workmanship for a period of one year from the date of shipment, as evidenced by receipts or other documentation. National Instruments will, at its option, repair or replace equipment that proves to be defective during the warranty period. This warranty includes parts and labor.

The media on which you receive National Instruments software are warranted not to fail to execute programming instructions, due to defects in materials and workmanship, for a period of 90 days from date of shipment, as evidenced by receipts or other documentation. National Instruments will, at its option, repair or replace software media that do not execute programming instructions if National Instruments receives notice of such defects during the warranty period. National Instruments does not warrant that the operation of the software shall be uninterrupted or error free.

A Return Material Authorization (RMA) number must be obtained from the factory and clearly marked on the outside of the package before any equipment will be accepted for warranty work. National Instruments will pay the shipping costs of returning to the owner parts which are covered by warranty.

National Instruments believes that the information in this document is accurate. The document has been carefully reviewed for technical accuracy. In the event that technical or typographical errors exist, National Instruments reserves the right to make changes to subsequent editions of this document without prior notice to holders of this edition. The reader should consult National Instruments if errors are suspected. In no event shall National Instruments be liable for any damages arising out of or related to this document or the information contained in it.

EXCEPT AS SPECIFIED HEREIN, NATIONAL INSTRUMENTS MAKES NO WARRANTIES, EXPRESS OR IMPLIED, AND SPECIFICALLY DISCLAIMS ANY WARRANTY OF MERCHANTABILITY OR FITNESS FOR A PARTICULAR PURPOSE. CUSTOMER'S RIGHT TO RECOVER DAMAGES CAUSED BY FAULT OR NEGLIGENCE ON THE PART OF NATIONAL INSTRUMENTS SHALL BE LIMITED TO THE AMOUNT THEREOF PAID BY THE CUSTOMER. NATIONAL INSTRUMENTS WILL NOT BE LIABLE FOR DAMAGES RESULTING FROM LOSS OF DATA, PROFITS, USE OF PRODUCTS, OR INCIDENTAL OR CONSEQUENTIAL DAMAGES, EVEN IF ADVISED OF THE POSSIBILITY THEREOF. This limitation of the liability of National Instruments will apply regardless of the form of action, whether in contract or tort, including negligence. Any action against National Instruments must be brought within one year after the cause of action accrues. National Instruments shall not be liable for any delay in performance due to causes beyond its reasonable control. The warranty provided herein does not cover damages, defects, malfunctions, or service failures caused by owner's failure to follow the National Instruments installation, operation, or maintenance instructions; owner's modification of the product; owner's abuse, misuse, or negligent acts; and power failure or surges, fire, flood, accident, actions of third parties, or other events outside reasonable control.

Copyright

Under the copyright laws, this publication may not be reproduced or transmitted in any form, electronic or mechanical, including photocopying, recording, storing in an information retrieval system, or translating, in whole or in part, without the prior written consent of National Instruments Corporation.

Trademarks

BridgeVIEW™, Lookout™, National Instruments™, NI-FBUS™, NI-FMON™, and ni.com™ are trademarks of National Instruments Corporation.

Product and company names mentioned herein are trademarks or trade names of their respective companies.

WARNING REGARDING USE OF NATIONAL INSTRUMENTS PRODUCTS

(1) NATIONAL INSTRUMENTS PRODUCTS ARE NOT DESIGNED WITH COMPONENTS AND TESTING FOR A LEVEL OF RELIABILITY SUITABLE FOR USE IN OR IN CONNECTION WITH SURGICAL IMPLANTS OR AS CRITICAL COMPONENTS IN ANY LIFE SUPPORT SYSTEMS WHOSE FAILURE TO PERFORM CAN REASONABLY BE EXPECTED TO CAUSE SIGNIFICANT INJURY TO A HUMAN.

(2) IN ANY APPLICATION, INCLUDING THE ABOVE, RELIABILITY OF OPERATION OF THE SOFTWARE PRODUCTS CAN BE IMPAIRED BY ADVERSE FACTORS, INCLUDING BUT NOT LIMITED TO FLUCTUATIONS IN ELECTRICAL POWER SUPPLY, COMPUTER HARDWARE MALFUNCTIONS, COMPUTER OPERATING SYSTEM SOFTWARE FITNESS, FITNESS OF COMPILERS AND DEVELOPMENT SOFTWARE USED TO DEVELOP AN APPLICATION, INSTALLATION ERRORS, SOFTWARE AND HARDWARE COMPATIBILITY PROBLEMS, MALFUNCTIONS OR FAILURES OF ELECTRONIC MONITORING OR CONTROL DEVICES, TRANSIENT FAILURES OF ELECTRONIC SYSTEMS (HARDWARE AND/OR SOFTWARE), UNANTICIPATED USES OR MISUSES, OR ERRORS ON THE PART OF THE USER OR APPLICATIONS DESIGNER (ADVERSE FACTORS SUCH AS THESE ARE HEREAFTER COLLECTIVELY TERMED "SYSTEM FAILURES"). ANY APPLICATION WHERE A SYSTEM FAILURE WOULD CREATE A RISK OF HARM TO PROPERTY OR PERSONS (INCLUDING THE RISK OF BODILY INJURY AND DEATH) SHOULD NOT BE RELIANT SOLELY UPON ONE FORM OF ELECTRONIC SYSTEM DUE TO THE RISK OF SYSTEM FAILURE. TO AVOID DAMAGE, INJURY, OR DEATH, THE USER OR APPLICATION DESIGNER MUST TAKE REASONABLY PRUDENT STEPS TO PROTECT AGAINST SYSTEM FAILURES, INCLUDING BUT NOT LIMITED TO BACK-UP OR SHUT DOWN MECHANISMS. BECAUSE EACH END-USER SYSTEM IS CUSTOMIZED AND DIFFERS FROM NATIONAL INSTRUMENTS' TESTING PLATFORMS AND BECAUSE A USER OR APPLICATION DESIGNER MAY USE NATIONAL INSTRUMENTS PRODUCTS IN COMBINATION WITH OTHER PRODUCTS IN A MANNER NOT EVALUATED OR CONTEMPLATED BY NATIONAL INSTRUMENTS, THE USER OR APPLICATION DESIGNER IS ULTIMATELY RESPONSIBLE FOR VERIFYING AND VALIDATING THE SUITABILITY OF NATIONAL INSTRUMENTS PRODUCTS WHENEVER NATIONAL INSTRUMENTS PRODUCTS ARE INCORPORATED IN A SYSTEM OR APPLICATION, INCLUDING, WITHOUT LIMITATION, THE APPROPRIATE DESIGN, PROCESS AND SAFETY LEVEL OF SUCH SYSTEM OR APPLICATION.

Compliance

FCC/Canada Radio Frequency Interference Compliance*

Determining FCC Class

The Federal Communications Commission (FCC) has rules to protect wireless communications from interference. The FCC places digital electronics into two classes. These classes are known as Class A (for use in industrial-commercial locations only) or Class B (for use in residential or commercial locations). Depending on where it is operated, this product could be subject to restrictions in the FCC rules. (In Canada, the Department of Communications (DOC), of Industry Canada, regulates wireless interference in much the same way.)

Digital electronics emit weak signals during normal operation that can affect radio, television, or other wireless products. By examining the product you purchased, you can determine the FCC Class and therefore which of the two FCC/DOC Warnings apply in the following sections. (Some products may not be labeled at all for FCC; if so, the reader should then assume these are Class A devices.)

FCC Class A products only display a simple warning statement of one paragraph in length regarding interference and undesired operation. Most of our products are FCC Class A. The FCC rules have restrictions regarding the locations where FCC Class A products can be operated.

FCC Class B products display either a FCC ID code, starting with the letters **EXN**, or the FCC Class B compliance mark that appears as shown here on the right.

Consult the FCC web site <http://www.fcc.gov> for more information.

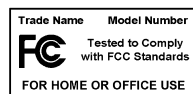

FCC/DOC Warnings

This equipment generates and uses radio frequency energy and, if not installed and used in strict accordance with the instructions in this manual and the CE Mark Declaration of Conformity**, may cause interference to radio and television reception. Classification requirements are the same for the Federal Communications Commission (FCC) and the Canadian Department of Communications (DOC).

Changes or modifications not expressly approved by National Instruments could void the user's authority to operate the equipment under the FCC Rules.

Class A

Federal Communications Commission

This equipment has been tested and found to comply with the limits for a Class A digital device, pursuant to part 15 of the FCC Rules. These limits are designed to provide reasonable protection against harmful interference when the equipment is operated in a commercial environment. This equipment generates, uses, and can radiate radio frequency energy and, if not installed and used in accordance with the instruction manual, may cause harmful interference to radio communications. Operation of this equipment in a residential area is likely to cause harmful interference in which case the user will be required to correct the interference at his own expense.

Canadian Department of Communications

This Class A digital apparatus meets all requirements of the Canadian Interference-Causing Equipment Regulations.

Cet appareil numérique de la classe A respecte toutes les exigences du Règlement sur le matériel brouilleur du Canada.

Class B

Federal Communications Commission

This equipment has been tested and found to comply with the limits for a Class B digital device, pursuant to part 15 of the FCC Rules. These limits are designed to provide reasonable protection against harmful interference in a residential installation. This equipment generates, uses and can radiate radio frequency energy and, if not installed and used in accordance with the instructions, may cause harmful interference to radio communications. However, there is no guarantee that interference will not occur in a particular installation. If this equipment does cause harmful interference to radio or television reception, which can be determined by turning the equipment off and on, the user is encouraged to try to correct the interference by one or more of the following measures:

- Reorient or relocate the receiving antenna.
- Increase the separation between the equipment and receiver.

- Connect the equipment into an outlet on a circuit different from that to which the receiver is connected.
- Consult the dealer or an experienced radio/TV technician for help.

Canadian Department of Communications

This Class B digital apparatus meets all requirements of the Canadian Interference-Causing Equipment Regulations.

Cet appareil numérique de la classe B respecte toutes les exigences du Règlement sur le matériel brouilleur du Canada.

European Union - Compliance to EEC Directives

Readers in the EU/EEC/EEA must refer to the Manufacturer's Declaration of Conformity (DoC) for information** pertaining to the CE Mark compliance scheme. The Manufacturer includes a DoC for most every hardware product except for those bought for OEMs, if also available from an original manufacturer that also markets in the EU, or where compliance is not required as for electrically benign apparatus or cables.

* Certain exemptions may apply in the USA, see FCC Rules §15.103 **Exempted devices**, and §15.105(c). Also available in sections of CFR 47.

** The CE Mark Declaration of Conformity will contain important supplementary information and instructions for the user or installer.

Contents

About This Manual

How To Use the Manual Set	ix
Conventions	ix
Related Documentation.....	xi

Chapter 1

Introduction

What You Need to Get Started	1-1
Hardware Description	1-1
Software Description	1-2
NI-FBUS Interface Configuration Utility	1-2
Choosing Configuration Software.....	1-3
Optional Fieldbus Network Tools.....	1-5

Chapter 2

Installation and Configuration

Install the Software	2-1
Configure the AT-FBUS Board.....	2-2
Select an Unused Interrupt Request Line	2-3
Change the Hardware Settings	2-4
Change the Interrupt Request Line	2-5
Using Polled Mode.....	2-5
Change the Memory Base Address	2-6
Install the AT-FBUS Board	2-9
Set the NI-FBUS Software to Use Your NI-FBUS Board.....	2-11
Set the Base Address and IRQ.....	2-11
Set the Communication Parameters and Interface Name	2-12
Configure Driver for Windows 2000.....	2-14
Test the Installation.....	2-14
Changing Resources to Eliminate Conflicts	2-16
Changing or Deleting Existing Interface Information.....	2-17
Import Device Descriptions	2-18
Fieldbus Cable Connector Pinout	2-19
Install and Wire Your Fieldbus Devices.....	2-20
Termination	2-20
Replacing Devices	2-20

Chapter 3

Start the NIFB Process

Configure NIFB to Load at System Startup	3-1
Begin to Use Your NI-FBUS Software	3-2

Appendix A

Specifications

Power Requirement	A-1
Physical	A-1
Operating Environment	A-1
Storage Environment	A-1

Appendix B

Troubleshooting and Common Questions

Error Messages	B-1
NIFB Problems	B-2
Interface Configuration Problems	B-4
Add New Hardware Problems	B-4
Resolving Resource Conflicts	B-4
Use a Different Memory Address	B-4
Put the Board in Polled Mode	B-5
Use a Visitor Address	B-5
Problems Using Manufacturer-Defined Features	B-5
Configuring Advanced Parameters	B-8
Uninstalling the Software	B-9

Appendix C

Technical Support Resources

Glossary

About This Manual

This manual contains instructions on how to install and configure the National Instruments AT-FBUS board and the NI-FBUS software. The AT-FBUS board is intended for use in PCs equipped with 16-bit ISA slots.

The NI-FBUS software is intended for use with Windows NT because Windows 98/95 is less robust than Windows NT. This manual assumes that you are already familiar with your Windows operating system.

How To Use the Manual Set

Use the *FOUNDATION Fieldbus Overview* to learn the basics of Fieldbus. The *FOUNDATION Fieldbus Overview* also includes tutorials to lead you through developing a simple Fieldbus application.

Use this getting started manual to install and configure your AT-FBUS board and the NI-FBUS software.

If you are using the NI-FBUS Configurator, use the *NI-FBUS Configurator User Manual* to install and use the NI-FBUS Configurator software.

If you are using the NI-FBUS Communications Manager Application Programmer Interface (API), use the *NI-FBUS Communications Manager User Manual* to learn how to use the NI-FBUS Communications Manager API for your application. Use the *NI-FBUS Communications Manager Function Reference Manual* to look up specific information about NI-FBUS Communications Manager functions, such as syntax and error messages.

Conventions

The following conventions appear in this manual:

- » The » symbol leads you through nested menu items and dialog box options to a final action. The sequence **File»Page Setup»Options** directs you to pull down the **File** menu, select the **Page Setup** item, and select **Options** from the last dialog box.
- ◆ The ◆ symbol indicates that the following text applies only to a specific platform.



This icon denotes a tip, which alerts you to advisory information.



This icon denotes a note, which alerts you to important information.



This icon denotes a caution, which advises you of precautions to take to avoid injury, data loss, or a system crash.



This icon denotes a warning, which advises you of precautions to take to avoid being electrically shocked.

AT-FBUS

In this manual, the term *AT-FBUS* refers to both the single-port AT-FBUS board and the dual-port AT-FBUS/2 board, unless otherwise indicated.

bold

Bold text denotes items that you must select or click on in the software, such as menu items and dialog box options. Bold text also denotes parameter names.

Fieldbus

The generic term *Fieldbus* refers to any bus that connects to field devices. This includes FOUNDATION Fieldbus, CAN, DNET, and Profibus. In this manual, the term *Fieldbus* refers specifically to the FOUNDATION Fieldbus.

italic

Italic text denotes variables, emphasis, a cross reference, or an introduction to a key concept. This font also denotes text that is a placeholder for a word or value that you must supply.

monospace

Text in this font denotes text or characters that you should enter from the keyboard, sections of code, programming examples, and syntax examples. This font is also used for the proper names of disk drives, paths, directories, programs, subprograms, subroutines, device names, functions, operations, variables, filenames and extensions, and code excerpts.

monospace bold

Bold text in this font denotes the messages and responses that the computer automatically prints to the screen. This font also emphasizes lines of code that are different from the other examples.

monospace italic

Italic text in this font denotes text that is a placeholder for a word or value that you must supply.

NI-FBUS software

In this manual, the term *NI-FBUS software* refers to either the NI-FBUS Communications Manager or NI-FBUS Configurator software.

Platform

Text in this font denotes a specific platform and indicates that the text following it applies only to that platform.

Related Documentation

The following documents contain information that you might find helpful as you read this manual:

General Fieldbus Websites

- Fieldbus Foundation—responsible for the definition of the FOUNDATION Fieldbus specification. www.fieldbus.org
- Relcom, Inc.—Wiring and test equipment for FOUNDATION Fieldbus. www.relcominc.com/fieldbus
- Fieldbus, Inc.—Device developers and FOUNDATION Fieldbus consulting. www.fieldbusinc.com

Fieldbus system development documentation

- Fieldbus Foundation resources
 - *Wiring and Installation 31.25 kbit/s, Voltage Mode, Wire Medium*
- Relcom Fieldbus resources online
 - Wiring Design and Installation Guide
 - Online Tutorial
 - FAQ
 - Sample Fieldbus Topologies
- *Fieldbus Standard for Use in Industrial Control Systems, Part 2, ISA-S50.02.1992*

Fieldbus device development documentation

- Developing Your First FOUNDATION Fieldbus Device, available from the Fieldbus, Inc. website at www.fieldbusinc.com
- *Foundation Specification: 31.25 kbit/s Physical Layer Profile* for the FOUNDATION Fieldbus Physical Layer Specifications
- *Function Block Application Process, Part 1*
- *Function Block Application Process, Part 2*
- IEC Standard 1158-2 and ISA Standard ISA S50.02

Introduction

This chapter lists what you need to get started and includes a brief description of the AT-FBUS board and the NI-FBUS software.

What You Need to Get Started

To install your NI-FBUS software, you need the following items:

- AT-FBUS board
- Installation disks
- Windows NT/98/95 installed on your computer



Note Because Windows 98/95 is less robust than Windows NT, National Instruments strongly suggests that you use a Windows NT system with the National Instruments Fieldbus software.

Hardware Description

The AT-FBUS is a plug-in board that handles communication between a network-configurable device that complies with the Fieldbus Foundation H1 specification and a PC that has a 16-bit ISA slot. The AT-FBUS uses an Intel 386EX embedded processor, shared memory, and an interrupt to communicate with its driver. The AT-FBUS supports the Fieldbus H1 transfer rate of 31.25 Kbits/s.

The single-port AT Fieldbus board is called the *AT-FBUS* and the dual-port AT Fieldbus board is called the *AT-FBUS/2*. In this manual, the term *AT-FBUS* refers to both the single-port AT-FBUS board and the dual-port AT-FBUS/2 board, unless otherwise indicated.

Software Description

Your kit includes either the NI-FBUS Communications Manager software or the NI-FBUS Configurator software. Depending on the system you purchase, you may receive both disks; if this is the case, you should use the NI-FBUS Configurator software.

The NI-FBUS Communications Manager software is used by the interface boards to communicate over the bus. Additionally, it provides a high-level API advanced users can use to interface with the National Instruments FOUNDATION Fieldbus communication stack and hardware.

Most users use the NI-FBUS Configurator. In addition to providing the functionality of the NI-FBUS Communications Manager in a graphical format, it includes additional functionality to allow you to configure a Fieldbus network. It can automatically generate the schedule for the network and configure field devices and hosts to transmit and receive alarms and trends.



Note The current NI-FBUS Communications Manager communication stack is not compatible with the communication stack in a Round Card from a National Instruments Device Developer Kit Release previous to Version 2.0. If you are using National Instruments Round Card software previous to Version 2.0, you need to upgrade your software. Contact National Instruments for ordering information.

NI-FBUS Interface Configuration Utility

The NI-FBUS Interface Configuration utility lets you view and change the hardware configuration parameters for your Fieldbus interfaces. In Windows NT, you can also edit your hardware configuration parameters and add and delete interfaces.

The NI-FBUS Interface Configuration utility helps you to configure the following information:

- Logical name for each port on your Fieldbus board; you can access the port using the interface name
- Device description information
 - Base directory for device description files
 - Location of the standard text dictionary

You need to import device descriptions if you use the NI-FBUS Communications Manager to communicate with devices that have manufacturer-specific blocks or parameters.

- Fieldbus communication parameters for each Fieldbus interface

In Windows 2000/NT, the NI-FBUS Configuration utility (`fbconf.exe`) helps you to configure the following hardware information. In Windows 98/95, you can view (but not change) this information:

- Number of boards
- Base address of each board
- IRQ line assigned to each board

To change the base address or IRQ settings in Windows 98/95, you must use the Windows Device Manager and Add New Hardware wizard, as described in *Configure the AT-FBUS Board* in Chapter 2, *Installation and Configuration*.



Caution Although the NI-FBUS Interface Configuration utility can be used to set certain low-level network software parameters, you should not modify the Advanced parameters without good reason. If you must modify parameters for certain devices, the device manufacturer will recommend settings. Modifying these parameters can have an adverse affect on data throughput rates. If settings are incorrectly modified, some devices might disappear off the bus.

Choosing Configuration Software

FOUNDATION Fieldbus links must be configured. Only with configuration software can you do things like set device addresses, clear devices, and download (necessary if you are setting up a system for the first time). Your configuration software must match the interface board your computer is using to connect to the bus. National Instruments offers the NI-FBUS Configurator with a National Instruments FOUNDATION Fieldbus interface board to let you configure your Fieldbus links.

Interface boards and configuration software are sold separately because multiple interface boards can reside in the same computer. The NI-FBUS Configurator, by default, is licensed for use on one machine, with up to four Fieldbus links (segments). If you have more than 4 links (ports on the boards), you need to purchase a link upgrade for each link in excess of four. To do so, download the order form from

www.ni.com/fieldbus



Note The connection to one interface port on the interface board is viewed as one link by the NI-FBUS Configurator, regardless of how many links might actually be joined by repeaters (important for software licensing of the NI-FBUS Configurator).

If you only want to use the board to read and write values only (not configure) and you are a programmer, you can make calls to the API in the NI-FBUS Communications Manager and would not need the NI-FBUS Configurator. This would be possible only if you have already used a third-party's hardware and configuration software to configure the link.

The following table describes the National Instruments Fieldbus software.

Table 1-1. National Instruments Fieldbus Software

Software Application	Short Name	Description	File Name
NI-FBUS Communications Manager	NIFB process	“The Blue Box”. This must be running for you to use your AT-FBUS board as a Fieldbus interface to communicate between the board and the bus.	nifb.exe
NI-FBUS Interface Configuration Utility	Interface Config	Used to configure your AT-FBUS board.	fbconf.exe
NI-FBUS Configurator	NI-FBUS Configurator	Used to configure the devices on the bus, set the parameters for control loops, and other Fieldbus configuration tasks.	fcs.exe
NI-FBUS Dialog System	NI-FBUS Dialog	Used to view the devices on the bus and manually read and write parameter values. Not for configuration.	nifbdlg.exe
NI-FBUS Fieldbus Monitor	NI-FMON; aka NI Fieldbus Monitor	Functions as a bus monitor, letting you view all packets sent over the bus. Primarily used by developers to debug new devices.	ni-fmon.exe

Table 1-1. National Instruments Fieldbus Software (Continued)

Software Application	Short Name	Description	File Name
Server Explorer	Server Explorer	Lets you configure the attributes of the communication resource, device, and items of your network, and the groups and items of your OPC server.	serverexplorer.exe

Optional Fieldbus Network Tools

Your kit includes either the NI-FBUS Communications Manager software, NI-FBUS Configurator software, or both. In addition, you can order the NI-FBUS Monitor, BridgeVIEW, and/or Lookout from National Instruments. If you have not already done so, you can also order the NI-FBUS Configurator.

The NI-FBUS Monitor helps you monitor and debug Fieldbus data traffic. It is primarily used to debug the development of device and host applications. It symbolically decodes data packets from the Fieldbus, monitors the live list (devices currently on the bus), and performs statistical analysis of packets.



Note If you are using this interface as a bus monitor, the other interface (if this is a two-port board) cannot be used for NI-FBUS. This means that you must have another link master on the link—either another AT-FBUS board, or a device with link master capabilities. An interface board can either run NI-FBUS software or NI-FMON software at any given time. If the board has two ports, they both must have the same usage. This is because a different stack is downloaded to the board for it to be used in conjunction with NI-FMON. Your interface board must be running NI-FBUS to act as the Link Active Scheduler. This means that if your interface board is the only link master on the link, you cannot use that board for running NI-FMON (even if the board has two ports) since that would leave the link without a link master. In this situation, you would need to obtain either a link master field device or another link master interface board in order to use NI-FMON.

BridgeVIEW helps you perform data acquisition and analysis, create a human-machine interface (HMI), or develop an advanced supervisory control application in a graphical development environment. BridgeVIEW includes real-time process monitoring, historical trending, alarm and event reporting, online configuration, and PLC connectivity.

Lookout helps you create graphical representations on a computer screen of real-world devices such as switches, dial gauges, chart recorders, pushbuttons, knobs, sliders, and meters. After linking these images to your field instruments, you can configure Lookout to generate alarms, log data to disk, animate custom graphics, print reports, automatically adjust setpoints, historically trend information, warn operators of malfunctions, and so on.

Installation and Configuration

Install the Software

- ◆ **Windows 2000/NT**—Complete the following steps to install your NI-FBUS software:



Caution If you are reinstalling the NI-FBUS software over an existing version, write down your board configuration and any port configuration parameters you changed from their defaults. Reinstalling may cause you to lose any existing board and port configuration information.

1. Log in as `Administrator` or as a user that has Administrator privileges.
2. Insert installation disk 1.
3. Select **Start»Run**.
4. In the **Run** dialog box, type the following:
`x:\setup`
where `x` is the letter of the drive containing the disk (usually `a` or `b`).
5. The interactive setup program takes you through the necessary steps to install the software.
6. At the end of the setup, an **Add New Board** dialog box may appear. If you have not yet installed your board, click on **Cancel**. You will install your board in a later step.

The installation program copies `nifb.dll` and `drvintf.dll` into your `\System32` directory, and it copies the `nifb.sys` kernel mode driver into the `\drivers` directory. The installation program also adds information to the Windows registry.

- ◆ **Windows 98/95**—Complete the following steps to install your NI-FBUS software:

The NI-FBUS software for Windows 98/95 requires DCOM. If you do not already have DCOM installed on your computer, you need to install it

before you install your NI-FBUS software. You can download a copy of DCOM from the MicrosoftCOM website at <http://www.microsoft.com/Com>

1. Insert installation disk 1.
2. Select **Start»Run**.
3. In the **Run** dialog box, type the following:
`x:\setup`
where *x* is the letter of the drive containing the disk (usually a or b).
4. The interactive setup program takes you through the necessary steps to install the software.

The installation program copies `nifb.dll`, `nifb.vxd`, and `drvintf.dll` into the `\System` directory. The installation program also adds information to the Windows Registry.

Continue to the next section to configure and install your board.

Configure the AT-FBUS Board

By default, the AT-FBUS board is set to use Memory Base Address 0x0D0000 and Interrupt Line (IRQ) 11. The default board settings are suitable for many computer systems. However, if these default settings conflict with another device in your system, or if you need to install more than one AT-FBUS board, you must change the default settings before you install the board. If you are installing more than one AT-FBUS board, each board must use a unique memory base address.

- ◆ **Windows 2000**—Select **Start»Settings»Control Panel»Administrative Tools»Computer Management»System Tools»System Information»Hardware Information**. Then, click on the **Memory** item.
- ◆ **Windows NT**—Select **Start»Programs»Administrative Tools (Common)»Windows NT Diagnostics**. Then, click on the **Resources** tab.
- ◆ **Windows 98/95**—Select **Start»Settings»Control Panel»System**. Click on the **Device Manager** tab. Select **Computer** and click on the **Properties** button. The **Computer Properties** dialog box appears.

Select an Unused Interrupt Request Line

PCs that support AT boards have a series of interrupt lines available to devices. Devices use interrupts to get immediate service from the CPU for asynchronous events.

1. Click on the **IRQ** button or select the **Interrupt request (IRQ)** radio button to view IRQ lines that your system is currently using.
2. Select an unused IRQ line. By default, your board is set to use IRQ11. Use this address if it is available. You can configure the AT-FBUS board to use any of the following interrupt lines: 3, 4, 5, 6, 7, 9, 10, 11, 12, 14, or 15.



Note The AT-FBUS cannot use an interrupt line that another device in your system is already using.

3. Write some unused IRQ line(s) in Table 2-1.

Table 2-1. Your Conflict-Free Resources

Hardware Setting	Selected Resource
IRQ Line	
Memory Base Address	

Select an Unused Memory Base I/O Address

The AT-FBUS board is a memory-mapped device, which means that the driver software can use the AT-FBUS memory registers as if they were standard memory. The memory base address of the AT-FBUS is the first position in the total memory address space occupied by the AT-FBUS.

The AT-FBUS is configured to use the default memory base address 0x0D0000. With this setting, the board uses the memory space from 0x0D0000 through 0x0D3FFF. Your computer's conventional DRAM and all other devices cannot use the memory space you assign to the AT-FBUS board.

1. Click on the **Memory** button or select the **Memory** radio button to view the I/O addresses that your system is currently using.
2. Select a base I/O address that does *not* appear in this window. By default, your board is set to use 0x0D0000. Use this address if it is available. Memory base address 0x0D4000 is unused in many systems. Table 2-2 lists all address ranges used by NI-FBUS.
3. Write some unused base I/O addresses in Table 2-1.



Note Even though an address does not show up in the device manager, it still may have conflicts. You will verify that your resources are conflict-free in the section *Set the NI-FBUS Software to Use Your NI-FBUS Board*.

Change the Hardware Settings



Warning Before you remove the AT-FBUS from the package, touch the antistatic plastic package to a metal part of your system chassis to discharge electrostatic energy, which can damage several components on your board.

Follow these instructions if you need to change the hardware settings of the AT-FBUS board.

Figure 2-1 shows the location of the switches, jumpers, and two connectors on the AT-FBUS/2 board. If you are using the single-port AT-FBUS, your board has only one connector.

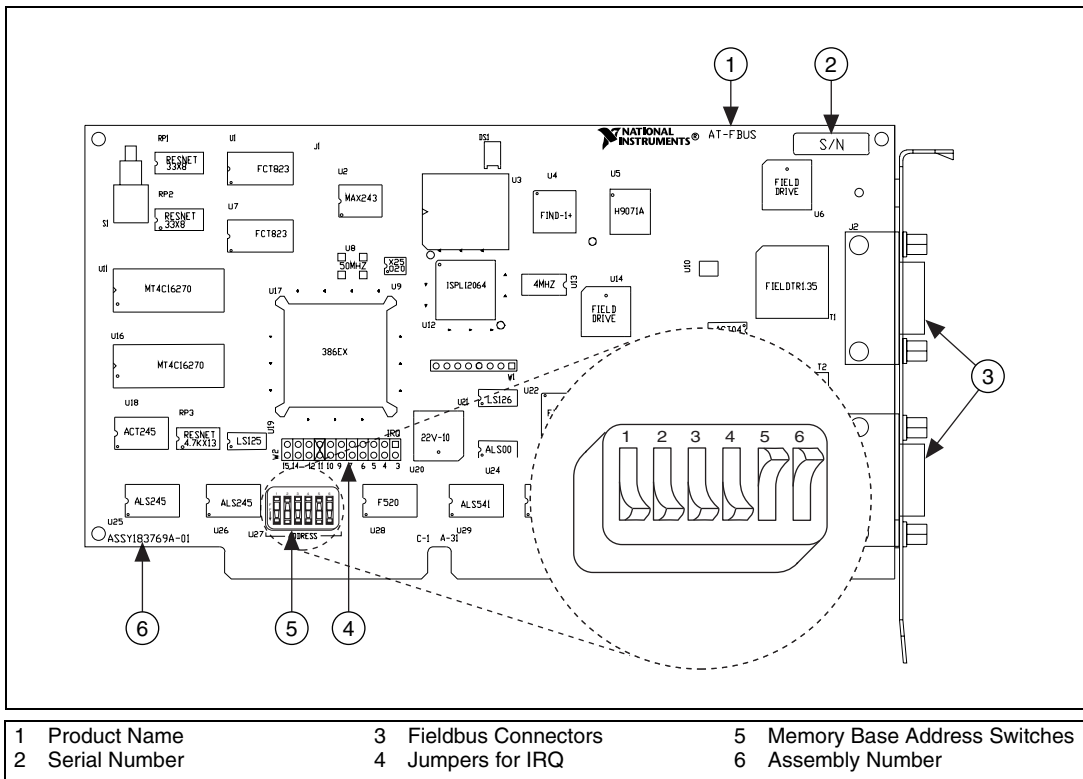

Figure 2-1. AT-FBUS/2 Parts Locator Diagram

Change the Interrupt Request Line

If you need to use an IRQ other than the default or if you are installing more than one board, complete the following steps to reconfigure the interrupt request line.

1. Find the jumpers that set the interrupt request line. Refer to Figure 2-1. The jumpers are located on the lower edge of your AT-FBUS board. The number on the board under each pair of pins corresponds to an AT bus interrupt level.
2. Change the jumper settings to configure the AT-FBUS board to a conflict-free interrupt request line that you wrote in Table 2-1. Place the jumper on the pair of pins directly above the number of the interrupt level you want.

By default, the AT-FBUS board uses interrupt request line 11. Figure 2-2 shows the setting for IRQ11.

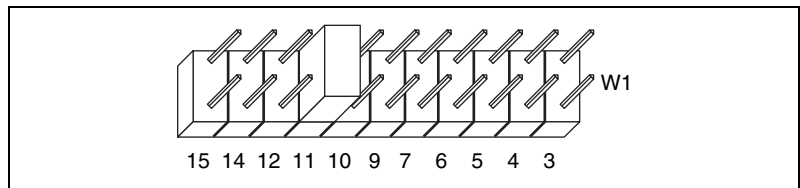

Figure 2-2. Interrupt Jumper Setting for IRQ11

Using Polled Mode

If you are installing more than one AT-FBUS board, no two boards can be configured for the same IRQ. If you do not have a free IRQ, you can configure your Fieldbus interface to operate in polled mode (no IRQ line). Polled mode allows the board to operate without an IRQ. In this situation, the board cannot request immediate service from the CPU. Instead, it is periodically polled by the driver to determine if an event needs handling. This results in a slow-down on the order of a few milliseconds.

To use polled mode, do not place the jumper across any pair of pins. To avoid losing your jumper, you can place it over any one pin, as shown in Figure 2-3.

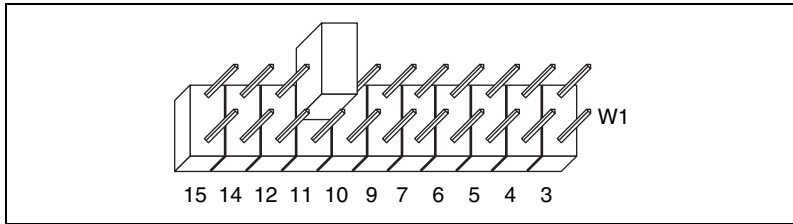

Figure 2-3. Interrupt Jumper Setting for No IRQ



Note Polled mode consumes more processor time, so you should only use it if there are no free IRQs in your system for the Fieldbus hardware to use. For more information about polled mode, refer to Appendix B, *Troubleshooting and Common Questions*.

Change the Memory Base Address

1. Locate the memory base address switches on your AT-FBUS board. Refer to Figure 2-1.
2. In Table 2-2, find one of the conflict-free memory base addresses you wrote in Table 2-1. Bold italic denotes default setting. Change the switch settings as indicated in Table 2-2. If 0x0D4000 was on your conflict-free list, this is often a good address to choose. Figure 2-4 shows the switches set to memory base address setting 0x0D4000.

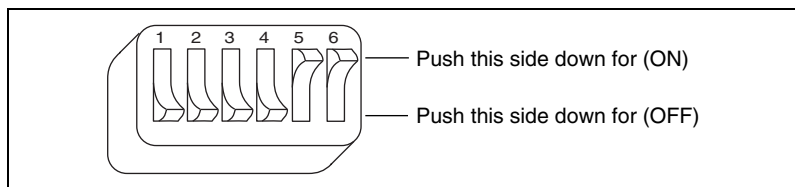

Figure 2-4. Memory Base Address 0x0D4000 Switch Setting

Table 2-2. Memory Base Address Switch Settings

Base Address	Top of Range	Hardware Setting	Switch Setting					
			SW1	SW2	SW3	SW4	SW5	SW6
0C0000	0C1FFF		ON	ON	OFF	ON	ON	OFF
0C4000	0C5FFF		ON	ON	OFF	ON	OFF	OFF

Table 2-2. Memory Base Address Switch Settings (Continued)







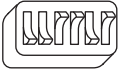

Base Address	Top of Range	Hardware Setting	Switch Setting					
			SW1	SW2	SW3	SW4	SW5	SW6
0C8000	0C9FFF		ON	ON	OFF	OFF	ON	OFF
0CC000	0CDFFF		ON	ON	OFF	OFF	OFF	OFF
0D0000	0D1FFF		ON	ON	ON	ON	ON	OFF
0D4000	0D5FFF		ON	ON	ON	ON	OFF	OFF
0D8000	0D9FFF		ON	ON	ON	OFF	ON	OFF
0DC000	0DDFFF		ON	ON	ON	OFF	OFF	OFF
0E0000	0E1FFF		ON	OFF	OFF	ON	ON	OFF
0E4000	0E5FFF		ON	OFF	OFF	ON	OFF	OFF
0E8000	0E9FFF		ON	OFF	OFF	OFF	ON	OFF
0EC000	0EDFFF		ON	OFF	OFF	OFF	OFF	OFF
0F0000	0F1FFF		ON	OFF	ON	ON	ON	OFF

Table 2-2. Memory Base Address Switch Settings (Continued)

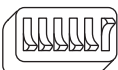
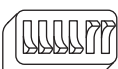

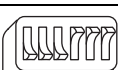
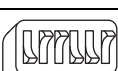

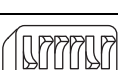
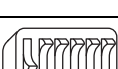





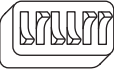

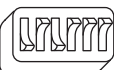

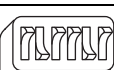
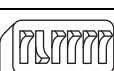
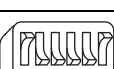
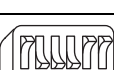
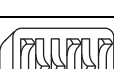
Base Address	Top of Range	Hardware Setting	Switch Setting					
			SW1	SW2	SW3	SW4	SW5	SW6
0F4000	0F5FFF		ON	OFF	ON	ON	OFF	OFF
0F8000	0F9FFF		ON	OFF	ON	OFF	ON	OFF
0FC000	0FDFFF		ON	OFF	ON	OFF	OFF	OFF
8C0000	8C1FFF		OFF	ON	OFF	ON	ON	OFF
8C4000	8C5FFF		OFF	ON	OFF	ON	OFF	OFF
8C8000	8C9FFF		OFF	ON	OFF	OFF	ON	OFF
8CC000	8CDFFF		OFF	ON	OFF	OFF	OFF	OFF
8D0000	8D1FFF		OFF	ON	ON	ON	ON	OFF
8D4000	8D5FFF		OFF	ON	ON	ON	OFF	OFF
8D8000	8D9FFF		OFF	ON	ON	OFF	ON	OFF
8DC000	8DDFFF		OFF	ON	ON	OFF	OFF	OFF

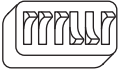
Table 2-2. Memory Base Address Switch Settings (Continued)

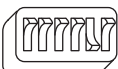
Base Address	Top of Range	Hardware Setting	Switch Setting					
			SW1	SW2	SW3	SW4	SW5	SW6
8E0000	8E1FFF		OFF	OFF	OFF	ON	ON	OFF
8E4000	8E5FFF		OFF	OFF	OFF	ON	OFF	OFF
8E8000	8E9FFF		OFF	OFF	OFF	OFF	ON	OFF
8EC000	8EDFFF		OFF	OFF	OFF	OFF	OFF	OFF
8F0000	8F1FFF		OFF	OFF	ON	ON	ON	OFF
8F4000	8F5FFF		OFF	OFF	ON	ON	OFF	OFF
8F8000	8F9FFF		OFF	OFF	ON	OFF	ON	OFF
8FC000	8FDFFF		OFF	OFF	ON	OFF	OFF	OFF

Install the AT-FBUS Board

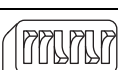

Note Before you install your board, double-check to make sure the settings on your board match the resources you have chosen.

1. Shut down your operating system and power off your computer. Keep the computer plugged in so that it remains grounded while you install the AT-FBUS board.
2. Remove the top cover or access port of the I/O channel.

3. Remove the expansion slot cover on the back panel of the computer.
4. As shown in Figure 2-5, insert the AT-FBUS board into any unused 16-bit ISA slot with the Fieldbus connector sticking out of the opening on the back panel. Make sure all pins are equally far into the connector. Although it might be a tight fit, do not force the board into place.

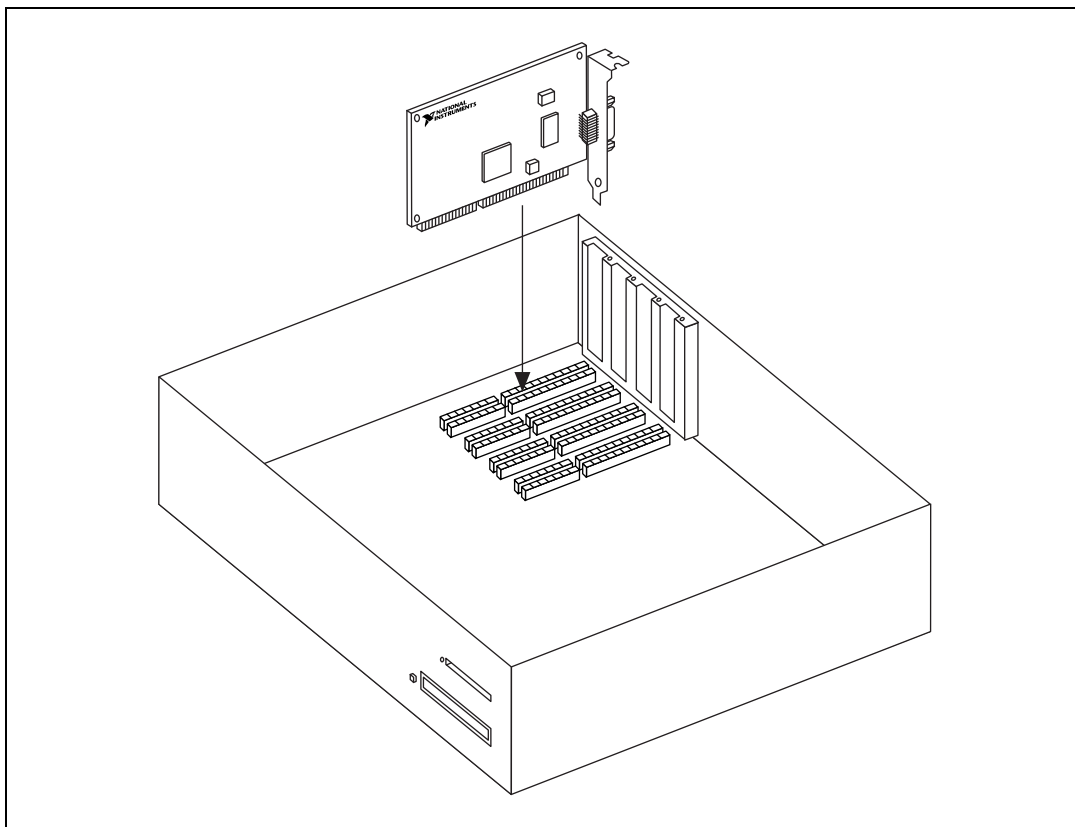

Figure 2-5. Installing the AT-FBUS Board

5. Screw the mounting bracket of the AT-FBUS board to the back panel rail of the computer.
6. Keep the top cover or access port off until you have verified that your resources are non-conflicting, as described in the next section, [Set the NI-FBUS Software to Use Your NI-FBUS Board](#).
7. Power on your computer.

Proceed to the next section, [Set the NI-FBUS Software to Use Your NI-FBUS Board](#).

Set the NI-FBUS Software to Use Your NI-FBUS Board

The physical settings on your AT-FBUS board must match the software settings you configure. Use the hardware settings you selected in the [Configure the AT-FBUS Board](#) section.



Note You can only connect one NI-FBUS port to a link or Fieldbus.

Set the Base Address and IRQ

- ◆ **Windows 2000/NT**—Use the NI-FBUS Interface Configuration utility to add, view, or change your base address or IRQ settings.
 1. Start the NI-FBUS Interface Configuration utility. Select **Start»Programs»National Instruments FBUS»Interface Config**.
 2. In the Interface Config window, select the icon of the board you want to change and click on the **Edit** button. If you are adding a board, click on the **Add Interface Device** button.
 3. Choose **ISA** as the **Bus Type**. The NI-FBUS Interface Configuration utility displays the default base address and IRQ line.
 4. Change the base memory address and interrupt request settings to match the settings you used when installing your board.

If you have configured your AT-FBUS board not to use interrupts, select **No Interrupt** from the **IRQ** drop-down list, and check the **Polled Mode** checkbox.
 5. If you are adding a board, select the number of ports that matches your AT-FBUS. For example, select 2 ports for the AT-FBUS/2.
 6. After verifying the information you just entered, click on the **OK** or **Add** button. The dialog box for entering port information for the Fieldbus interface appears.
 7. Click on **OK**.

Proceed to the next section, [Set the Communication Parameters and Interface Name](#).

- ◆ **Windows 98/95**—Use the Add New Hardware wizard to add your AT-FBUS board, and use the Device Manager to configure resources for the AT-FBUS board.
 1. Add your AT-FBUS board:
 - a. To open the Add New Hardware Wizard, select **Start»Settings»Control Panel»Add New Hardware**.

- b. When asked if Windows should search for new hardware, select **No** to keep Windows from trying to detect the hardware automatically (Windows cannot detect Fieldbus adapters). Click on the **Next** button.
 - c. Select **Other Devices** from the **Hardware Types** list that appears, and click on **Next**.
 - d. In the dialog box that appears, select **National Instruments** in the **Manufacturers** list on the left. In the **Models** list, select **AT-FBUS (1 Port)** or **AT-FBUS/2 (2 Port)**, depending on which board you are installing. Click on the **Next** button, twice in a row.
 - e. Click on the **Finish** button. In the dialog box that asks if you want to shut down, click on **No**.
2. Verify that the computer has assigned valid resources.
 - a. To open the Device Manger, select **Start»Settings»Control Panel»System**, then click on the **Device Manager** tab.
 - b. Click on the Fieldbus adapters icon, select the AT-FBUS board, and click on the **Properties** button. The **AT-FBUS Properties** dialog box appears.
 - c. Click on the **Resources** tab.
 - d. Configure resources for your AT-FBUS board. If you want to use polled mode, select a Basic Configuration that does not include an IRQ.

Make sure the **Resource Settings** match the jumper and switch settings configured on your AT-FBUS board. You can change a setting by double-clicking on the setting in the **Resource settings** list, or by selecting the resource type and clicking on the **Change Settings** button. The **Conflicting device list** field shows if there are any known conflicts with the resources you choose.
 - e. After you have selected nonconflicting resources, click on the **OK** button twice to save your changes.

Set the Communication Parameters and Interface Name

Use the NI-FBUS Interface Configuration utility to set the Fieldbus communication parameters and interface name.

1. Start the NI-FBUS Interface Configuration utility. Select **Start»Programs»National Instruments FBUS»Interface Config**.
2. Select the port you want to edit, and click on the **Edit** button.
3. The NI-FBUS Interface Configuration utility displays the default interface name and some configuration information.

4. Enter an interface name for the port, or use the default name. The interface name is for local use on the PC.
5. Enter a unique tag in the **Device Tag** field, or use the default device tag. The device tag is the name visible on the Fieldbus to the other devices.
6. Your interface must be given either a fixed or visitor device address for you to start using NI-FBUS. This address must be unique on the link to which the interface is connected.

- a. To assign a fixed address to your Fieldbus interface, choose **Fixed Address** and enter a value in the range 0x10 to 0xF7.

By convention, the lower addresses starting at 0x10 are usually used for interface boards and link masters. Upper addresses, starting at 0xF7 and working down, are generally used for other devices. Using a lower address for your interface will reduce the likelihood that the interface will conflict with another device on the bus.

- b. If you want your interface to be a temporary device that you do not intend to connect to the Fieldbus for an extended time, choose **Visitor Address**. Over a long period of time, using a visitor address could break VCR endpoints and cause VCR_FULL_ERROR errors.
 - c. If you want third-party Fieldbus configuration software to assign an address to your interface over the Fieldbus, choose **Default Address**. You should only choose to use a default address when you want third-party configuration software to assign a permanent address. A device at a default address cannot be communicated with until a permanent address has been assigned by the configuration software.
7. Select a Device Type. You should choose to use **Link Master Device**.
 8. Make sure that **NI-FBUS** is selected for **Usage**, unless you will be using the board in conjunction with the NI-FMON software.

If you are using this interface as a bus monitor, the other interface (if this is a two-port board) cannot be used for NI-FBUS. This means that you must have another link master on the link—either another AT-FBUS board, or a device with link master capabilities. See the section *Optional Fieldbus Network Tools* in Chapter 1, *Introduction*, for more information.

9. NI-FBUS assigns default values for other network communication parameters.



Caution Do *not* modify the **Advanced** parameters without good reason. If you must modify parameters for certain devices, the device manufacturer will recommend settings. Modifying these parameters can have an adverse affect on data throughput rates. If settings are incorrectly modified, some devices might disappear off the bus.

10. Click on **OK**, then click on **OK** again to exit the configuration utility.
11. Restart the NIFB process by selecting **Start»Programs»National Instruments FBUS»NIFB** to make the changes you made in the NI-FBUS Interface Configuration utility take effect.
12. Under **Windows NT**, if you change or delete the interface configuration, you must stop and restart the NI-FBUS Communications Manager `nifb.exe` so that the new configuration will take effect. You can start or stop the driver by selecting **Start»Settings»Control Panel»Devices»Nifb**, and clicking on the **Stop/Start** button.
13. Replace the top cover on your computer, if you have not done so already.

Configure Driver for Windows 2000

1. Select **Start»Settings»Control Panel»System»Hardware»Device Manager**. From the menu, select **View»Show hidden devices**.
2. From the list of non-Plug & Play devices, right-click on **NIFB** and select **Properties**.
3. Select **Driver** from the **Properties** page that appears. You can now start the driver by clicking on the **Start** button. To set the driver to be started up automatically at system start-up, set the **Startup Type** to **Automatic**.
4. To view/troubleshoot the hardware resources being used by your AT-FBUS interface board, select **Nifb»Properties»Resources**. The **Nifb Properties** dialog box appears. If you need to change any resources, use the Interface Configuration utility. Do not change properties from this dialog box.

Test the Installation

- ◆ **Windows 2000**—To make sure that your NI-FBUS software is installed correctly and is working properly, complete the following steps:
 1. Select **Start»Settings»Control Panel»System»Hardware»Device Manager**. From the menu, select **View»Show Hidden Devices**.

2. From the list of non-Plug & Play devices, right-click on **NIFB** and select **Properties**.
 3. Select **Driver** from the **Properties** page that appears. You can now start the driver by clicking on the **Start** button.
 4. Start the NIFB process by selecting **Start»Programs»National Instruments FBUS»NIFB**.
- ◆ **Windows NT**—To make sure that your NI-FBUS software is installed correctly and is working properly, complete the following steps:
 1. After you configure your installation, restart Windows. You must restart your computer before you can use the NI-FBUS software.
 2. Start the kernel-mode device driver NIFB by selecting **Start»Settings»Control Panel»Devices»Nifb** and clicking on the **Start** button



Tip You can have the device driver start automatically when your computer boots. Refer to Chapter 3, *Start the NIFB Process*, for instructions.

3. Start the NIFB process selecting **Start»Programs»National Instruments FBUS»NIFB**.
- ◆ **Windows 98/95**—Start the NIFB process by selecting **Start»Programs»National Instruments FBUS»Nifb**. The NIFB process must be running in the background to use any Fieldbus application.

On successful startup, the NIFB displays a message saying that the process started up successfully, the title bar of the NIFB window changes to **NI-FBUS (running)**, and a blue box icon appears on the Windows taskbar. It may take a few minutes for NIFB to start up and this message to display.

If NI-FBUS does not start up successfully, the base memory address, IRQ line, or Fieldbus network address is incorrect. If the NIFB process does not start up successfully, refer to Appendix B, *Troubleshooting and Common Questions*.

Changing Resources to Eliminate Conflicts



Note If you do not suspect you have resource conflicts, proceed to Chapter 3, *Start the NIFB Process*.

If you discovered resource conflicts when testing the installation, you need to change your base address or IRQ settings. To change these settings, follow these steps, then refer to the section *Configure the AT-FBUS Board*.

- ◆ **Windows 2000**—Windows usually assigns conflict-free resources automatically. To view assigned resources, complete the following steps:
 1. Select **Start»Settings»Control Panel»System»Hardware»Device Manager**. From the menu, select **View»Show Hidden Devices**.
 2. From the list of non-Plug & Play devices, double-click on **NIFB**.
 3. Make sure the settings shown match the settings configured on your board. You may need to shut down your computer and remove the board to re-configure your board settings to match those shown in the Device Manager.
 4. Click on **OK** twice.
- ◆ **Windows NT**—Windows usually assigns conflict-free resources automatically. To view assigned resources, complete the following steps:
 1. Select **Start»Programs»Administrative Tools (Common)»Windows NT Diagnostics**, and select the **Resources** tab.
 2. Click on the **Devices** button.
 3. Double-click on **nifb**.
 4. Make sure the settings shown match the settings configured on your board. You may need to shut down your computer and remove the board to re-configure your board settings to match those shown in the Windows NT Diagnostics.
 5. Click on **OK** twice.
- ◆ **Windows 98/95**—To change resources to eliminate conflicts, complete the following steps:
 1. Select **Start»Settings»Control Panel**, and double-click on the **System** icon.
 2. Click on the **Device Manager** tab.
 3. Locate your board under the heading **Fieldbus Adapters**.

4. Click on the name of the board, then click on the **Properties** button.
5. Use the **Resources** tab to view or edit the resources assigned to the board.



Note After you change the resource settings, shut down your computer and move the hardware jumper and switches to match. See the [Change the Hardware Settings](#) section, earlier in this chapter, for information on changing the hardware settings.

Changing or Deleting Existing Interface Information

- ◆ **Windows 2000/NT**—To change or delete information about any interface that you have already entered, complete the following steps:
 1. Select **Start»Programs»National Instruments FBUS»Interface Config**
 2. Click on the **Board x** icon, where x refers to the board number of the interface you want to change or delete.
 3. Click on the **Edit** button. You can edit the interface configuration information that you entered earlier, or click on **Delete** to delete this interface entirely.

Interfaces are numbered beginning with zero. If you delete an interface, the NI-FBUS Interface Configuration utility renumbers all the remaining interfaces. For example, if you delete **Board0**, it appears that you deleted the last interface, because all the remaining interface numbers are decreased by one automatically.

Table 2-3. Board Renumbering

Original Address	Address after Deleting Board1
Board0	Board0
Board1	(deleted)
Board2	Board1
Board3	Board2

- ◆ **Windows 98/95**—To change the hardware resources in Windows 98/95, you must use the Windows Device Manager rather than the NI-FBUS Interface Configuration utility. For more information, refer to the [Changing Resources to Eliminate Conflicts](#) section.

To delete a National Instruments Fieldbus interface in Windows 98/95, complete the following steps.

1. Select **Start»Settings»Control Panel**, and double-click on the **System** icon.
2. Click on the **Device Manager** tab.
3. Locate your board under the heading **Fieldbus Adapters**.
4. Click on the name of the board, then click on the **Remove** button.

Run the NI-FBUS Interface Configuration utility once to make sure the interface has been removed.

To re-install the interface, refer to the installation and configuration instructions earlier in this chapter.

Import Device Descriptions

The device description files contain information about the types of blocks and parameters supported by your Fieldbus device, along with online help describing the uses of given parameters. If your Fieldbus device uses manufacturer-specific device description files, you must import the device description files (shipped with the device, or available from the device manufacturer). To do so, complete the following steps:

1. Insert the device description disk or CD (if supplied by your Fieldbus device manufacturer) into the disk drive of the host computer.
2. Select **Start»Programs»National Instruments FBUS»Interface Config** to run the Interface Configuration utility.
3. Click on the **DD Info** button. The **DD Info** dialog box appears.
4. If the base directory field is blank, enter a base directory. The base directory you enter here will be where NI-FBUS looks for all device descriptions. Do not change the base directory after you have started importing device descriptions; otherwise, NI-FBUS will not be able to find the device descriptions you previously imported. Your device description files will automatically be placed in the appropriate manufacturer ID subdirectory under this base directory.

Your base directory will include one folder for each different manufacturer for which you have imported device description. For example, if you import the device description for the National Instruments FP-3000 device, you will find a folder called 4e4943. This is the National Instruments FOUNDATION Fieldbus device manufacturer ID number.

The next layer of folders is the device type. For example, the FP-3000 has a device type ID number of 4005.

Underneath this layer of directories you will find the individual device description files (.ffo and .sym)

5. If necessary, click on the **Browse** button to select the standard text dictionary, provided with NI-FBUS. The text dictionary has a .dct extension.
6. Click on the **Import DD** button. The **Import DD** dialog box appears.
7. Click on the **Browse** button, browse to the .ffo device description file path, and click on **Open**. Typically, the device description for your Fieldbus device is supplied on a disk from the manufacturer. For each device, there are two device description files, one that ends in .ffo and one that ends in .sym. Select the .ffo file, and the corresponding .sym file will be imported automatically. The file name will be in the form *Digit Digit Digit Digit.ffo* (for example, 0101.ffo).



Note If you are importing device descriptions for multiple devices, you might see that they can have the same filenames. Each file contains information about the device and its manufacturer, and will be placed appropriately in the hierarchy under the base directory.

8. Click on **OK**. A window will appear that gives the full path to which the .ffo and .sym files were copied.
9. Click on **OK**.

For more information on device descriptions, refer to the section *Device Descriptions* in the *FOUNDATION Fieldbus Overview* document.

Fieldbus Cable Connector Pinout

If you want to make your own Fieldbus cable, make sure that it uses pins 6 and 7 for the Fieldbus signals, as shown in Figure 2-6, and make sure that it follows the specification in the *Fieldbus Standard for Use in Industrial Control Systems, Part 2, ISA-S50.02.1992*. Figure 2-6 shows the connector pinout of the AT-FBUS.

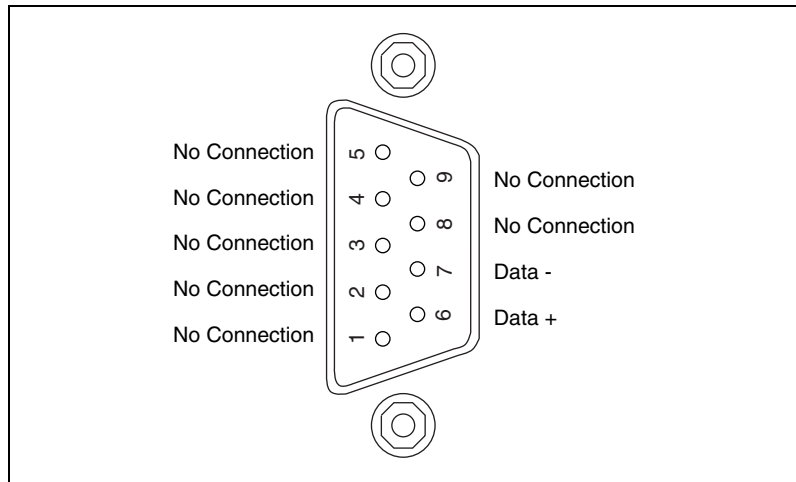

Figure 2-6. Fieldbus Connector Pinout for the AT-FBUS

Install and Wire Your Fieldbus Devices

What you need:

- Cable compliant with the *Fieldbus Standard for Use in Industrial Control Systems, Part 2, ISA-S50.02.1992*
- Terminator(s) with capacitor and resistor of appropriate size

Refer to the documentation that came with your device for complete instructions on how to install and wire your Fieldbus devices.

Termination

You must terminate your wiring in compliance with the FOUNDATION Fieldbus specification. FOUNDATION Fieldbus requires a resistor and a capacitor in parallel. You must place termination appropriately on the network, which will depend on your network topology. Refer to *Wiring and Installation 31.25 kbit/s, Voltage Mode, Wire Medium*, or the Relcom, Inc. *Wiring Design and Installation Guide*.

Replacing Devices

NI-FBUS is capable of dynamic device replacement. There is no need to restart NI-FBUS if a device on the link has its application changed (but its device ID remains the same).

Start the NIFB Process

The NIFB process must be running any time you want to use your AT-FBUS board as a Fieldbus interface to communicate between the board and the bus.

- ◆ **Windows 2000/NT**—If the NIFB kernel-mode driver has not already been started, you must do so manually.
 1. Start the kernel mode driver NIFB by selecting **Start»Settings»Control Panel»Devices»Nifb** and clicking on the **Start** button.
 2. Start the NIFB process by selecting **Start»Programs»National Instruments NIFB»Nifb**.
- ◆ **Windows 98/95**—Start the NIFB process by selecting **Start»Programs»National Instruments NIFB»Nifb**.

Configure NIFB to Load at System Startup

If the driver and the process start up successfully, you can configure the kernel-mode driver (for Windows NT) and NIFB process to start automatically when you boot or restart your computer.



Note To do this on a Windows NT machine, you must be running Windows NT 4.0 or later.

- ◆ **Windows 2000/NT**—Select **Start»Settings»Control Panel»Devices»Nifb**. Click on the **StartUp** button. Select **Automatic**. Then, place a shortcut to `NIFB.exe` in your Windows StartUp folder.
- ◆ **Windows 98/95**—Add the **NIFB** shortcut to the **StartUp** folder. Refer to your Microsoft Windows online help for information on adding programs to the **StartUp** folder.

Begin to Use Your NI-FBUS Software

If you are using the NI-FBUS Communications Manager, proceed to the *NI-FBUS Communication Manager User Manual* for information on using your software. If you are using the NI-FBUS Configurator, proceed to the *NI-FBUS Configurator User Manual* for information on using your software.

If NI-FBUS is unable to connect to and initialize an interface device, and you decide to continue NI-FBUS startup, NI-FBUS will not try to reconnect to that interface again. This is true of all interface types supported by this software.

If a AT-FBUS interface is configured as a basic device, a link master device must be present on this link before NI-FBUS will start up.

Specifications

This appendix describes the electrical, physical, and environmental characteristics of the AT-FBUS hardware and the recommended operating conditions.

Power Requirement

AT-FBUS.....	750 mA Typical
AT-FBUS/2.....	820 mA Typical

Physical

Dimensions.....	10.7 by 19.1 cm (4.2 by 7.5 in.)
I/O Connector.....	DB-9 DSUB (1 per Fieldbus link)

Operating Environment

Component temperature	0 to 70 °C
Relative humidity	10% to 90%, noncondensing

Storage Environment

Temperature.....	–40 to 125 °C
Relative humidity	5% to 90%, noncondensing
EMI	FCC Class B Certified

Troubleshooting and Common Questions

This appendix describes how to troubleshoot common problems that occur while getting started with Fieldbus.

Error Messages

Unable to download stack to board X

You might have a memory base address conflict. Try configuring your board to use a different base address, as described in Chapter 2, *Installation and Configuration*.

Utility could not access or locate the registry

- If using Windows 2000/NT, make sure you are logged in to Windows with administrator privileges.
- Your registry entries for NI-FBUS may have been deleted or corrupted. Uninstall the NI-FBUS software, then reinstall the software as described in the section *Install the Software* in Chapter 2, *Installation and Configuration*.

Board cannot be found

- Verify the base address, switches, and IRQ settings as described in the section *Configure the AT-FBUS Board* in Chapter 2, *Installation and Configuration*.
- Select **Start»Programs»National Instruments FBUS»Interface Config**. Make sure your board appears under the list of interfaces.
- Make sure the kernel-mode driver is started. To start the driver, select **Start»Settings»Control Panel»Devices»Nifb**. Click on the **Start** button. To avoid manual startup in the future, click on **Startup** and select **Automatic**.

VCR_FULL_ERROR

Delete the board from the Interface Configuration utility, then re-install.

NIFB Problems

When using the AT-FBUS board with Windows 2000/NT, Nifb returns an error message stating that the board cannot be found.

- Verify the base address, switches, and IRQ settings as described in the section *Configure the AT-FBUS Board* in Chapter 2, *Installation and Configuration*.
- Select **Start»Programs»National Instruments FBUS»Interface Config**. Make sure your board appears under the list of interfaces.
- Make sure the kernel-mode driver is started.
 - **Windows 2000**—Select **Start»Settings»Control Panel»System»Hardware»Device Manager**. From the menu, select **View»Show Hidden Devices**. From the list of non-Plug & Play devices, right-click on **NIFB** and select **Properties**. Click on the **Start** button. To avoid manual startup in the future, click on **Startup** and select **Automatic**.
 - **Windows NT**—Select **Start»Settings»Control Panel»Devices»Nifb**. Click on the **Start** button. To avoid manual startup in the future, click on **Startup** and select **Automatic**.

When a Fieldbus device is connected to the bus, the NIFB process often hangs when the title bar reads Waiting for Startup Completion. If I disconnect the cables, it starts fine.

This is probably due to a device address conflict. In the NI-FBUS Interface Configuration utility, make sure that the interface is not at the same address as anything else on the link. You can also temporarily give the interface a visitor address to troubleshoot this problem.

The NIFB process hangs, does not start up, or never shows that it is running.

- The board's base memory address conflicts with another device or does not match the setting on the board's switches. Check that the switches match the Windows settings, or try using a different base memory address. Windows does not always detect all conflicts. Even if Windows reports no conflicts, trying a different address after you have eliminated the IRQ or Fieldbus network address will often resolve the problem. You have to reboot the machine each time you change base address and/or IRQ.

- The board's IRQ conflicts with another device or does not match the jumper setting on the board. Check the jumper or try setting the board to polled mode.
- The Fieldbus network address is not unique. Remove the cable from the board. Restart the NIFB process. If it runs successfully, there is probably a Fieldbus network address conflict. If you have FP-3000 network modules on the bank, turning their power off and then back on will cause them to look on the bus for available addresses and change addresses if necessary. If this does not solve the problem, you can try to change the board's address. In the Interface Configuration utility, select the port and click on **Edit**. Make sure that the port does not have an address that conflicts with another device on the bus. You can also set the interface to a visitor address. In this case, the board will find and take an unused address. If this corrects the problem, find and change the address of one of the conflicting devices. Return the board to a fixed address.
- Check for multiple copies of `nifb.dll` on the machine. If multiple copies are found, NI-FBUS was incorrectly re-installed. Uninstall NI-FBUS, search for any remaining copies of `nifb.dll`, delete them, then reinstall the software.
- In Windows 98/95, you can check the Windows Device Manager to see if Windows has detected any problems or conflicts in the resources assigned to your AT-FBUS board. Your board(s) will appear under the **Fieldbus Adapters** category. The Device Manager displays an exclamation mark (!) on the icon of any AT-FBUS board that has resource conflicts.
- Check how many boards are showing up in the Interface Configuration utility. Make sure that this matches the number of boards in the system. Also check that the number of ports match the physical hardware (one port versus two port boards).
- Link masters do not always get along together (if you have another link master on the link). Try setting the board to be a basic device in the Interface Configuration utility.

If an AT-FBUS interface is configured as a basic device, another link master device must be present on this link before the NI-FBUS process will start up. For more about Basic and Link Master devices, refer to the *FOUNDATION Fieldbus Overview* document.

Interface Configuration Problems

When using the NI-FBUS Interface Configuration utility on a Windows 2000/NT machine, the error message utility could not access or locate the registry appears.

1. Make sure you are logged in to Windows with administrator privileges.
2. Your registry entries for NI-FBUS may have been deleted or corrupted. Uninstall the NI-FBUS software, then reinstall the software as described in the section *Install the Software* in Chapter 2, *Installation and Configuration*.

In the Interface Configuration utility, I see more boards than what physically exist in the machine.

- ◆ **Windows 2000/NT**—Select **Edit** for the extra board. In the next window, select **Delete**.
- ◆ **Windows 98/95**—Contact National Instruments to get information on cleaning the Windows registry.



Caution You should *not* attempt to make unguided changes in the Windows registry. Doing so can cause many problems with your system.

Add New Hardware Problems

In Add New Hardware on Windows 98/95, there is no category for Fieldbus.

The category **Fieldbus Adapters** will not appear under the type of hardware listing in **Add New Hardware** unless you reboot the computer twice after installing the software. After you install your first board, it will always show up. If the **Fieldbus Adapters** category does not appear, you can still follow the instructions in *Set the Base Address and IRQ* in Chapter 2, *Installation and Configuration*.

Resolving Resource Conflicts

Use a Different Memory Address

The Device Manager in Windows 98/95 or NT Diagnostics in Windows 2000/NT does not report all resource conflicts. If you are having

problems with your current resource settings, try different ones. Memory base address 0x0D4000 is free on many systems.

Put the Board in Polled Mode

Putting the board in polled mode is a good way to eliminate one variable. To put the board in polled mode:

- ◆ **Windows 2000/NT**—Use the Interface Configuration utility:
 1. Select **Start»Programs»National Instruments FBUS»Interface Config**.
 2. In the Interface Config window, select the icon of the board you want to change and click on the **Edit** button. If you are adding a board, click on the **Add Interface Device** button.
 3. Check the **Polled Mode** checkbox.
 4. Note the memory base address your board is using. Select a different Basic Configuration that does not include an IRQ. This is the polled mode option. Then, change the memory base address back to its original setting.
- ◆ **Windows 98/95**—Use the Device Manger.
 1. Select **Start»Settings»Control Panel»System**, then click on the **Device Manager** tab.
 2. Click on the Fieldbus adapters icon, select the AT-FBUS board, and click on the **Properties** button. The **AT-FBUS Properties** dialog box appears.
 3. Click on the **Resources** tab.

Note the memory base address your board is using. Select a different Basic Configuration that does not include an IRQ. This is the polled mode option. Then, change the memory base address back to its original setting.

Use a Visitor Address

Using a visitor address is a good way to troubleshoot an address conflict since the board will find and take an available address.

Problems Using Manufacturer-Defined Features

NI-FBUS uses identifying information in the actual device to locate the device description for the device. The identifying information includes four resource block parameters: `MANUFAC_ID`, `DEV_TYPE`, `DEV_REV`, and

`DD_REV`. If the identifying information is incorrect, NI-FBUS will not be able to locate the device description for the device. When it has located the device description, NI-FBUS matches the block types in the device description with the actual blocks in the device by using the Item ID of the block characteristics record.

If the blocks in the device do not match the blocks in the description, or if there is no appropriate device description for the manufacturer, device type, device revision and device description revision being returned by the device, then there is a device description mismatch. In either case, NI-FBUS uses only the standard dictionary (`nifb.dct`) and you will be unable to use any manufacturer-supplied functionality.

These parameters can be read from the device's resource block. The following procedure will help you troubleshoot a `DD_SIZE_MISMATCH_ERROR` by finding out if there is a device description available on your computer that matches what your device expects.

Follow these steps to use the NI-FBUS Dialog utility to check device description files.

1. Start the NIFB process. Wait until the process has finished initializing.
2. Select **Start»Programs»National Instruments FBUS»NI-FBUS Dialog**.
3. Right-click on **Open Descriptors** and choose **Expand All**.
4. After the expansion is complete, click on **Cancel** to close the Expand All window.
5. Right-click on the resource block for your device (it should be under **Open Descriptors»Session»Interface Name»Device Name»VFD Name»Resource Block Name**). Select **Read Object**.
6. Select the **Read by Name** radio button and enter `MANUFAC_ID` as the name. Click on the **Read** button. Write down the hexadecimal number found in parenthesis (0xnumber) in Table B-1.
7. Repeat step 6 for the name `DEV_TYPE`.
8. Repeat step 6 for the name `DEV_REV`.
9. Repeat step 6 for the name `DD_REV`.
10. Repeat steps 5–9 for each device, then close the NI-FBUS Dialog utility.

Table B-1. Device Names

Resource Block Parameter	Name
MANUFAC_ID	
DEV_TYPE	
DEV_REV	
DD_REV	

11. In the Interface Configuration utility, click on the **DD Info** button. Write down the base directory specified for device descriptions. Close the Interface Configuration utility.
12. Use Windows Explorer to view the contents of the base directory specified in the Interface Configuration utility. The Fieldbus specification defines the directory hierarchy for storing device descriptions. There is a different subdirectory for each device manufacturer. Under the base directory, you should see a directory with the number from step 6 for the first device.
13. Under the appropriate manufacturer directory, there is a directory for each device type that you have from that manufacturer. Check to make sure that you see a directory with the number from step 7.
14. Under the appropriate device type directory, there are the individual device descriptions. The device description file name is a combination of the device revision (the number from step 8) and the device description revision (the number from step 9). The device revision is the first two digits, and the device description revision is the second two digits. For example, if your number from step 8 was 2 and from step 9 was 1, you should see files called 0201.ffo and 0201.sym. Device descriptions are backwards compatible. This means that instead of seeing 0201, you might see 0202. This is allowed by the Fieldbus specification. Also, having additional files in this directory is not a problem. The NI-FBUS Configurator will use the most recent device description revision for a given device revision. If you do not have the appropriate .ffo and .sym files, you must obtain them from the device manufacturer. Be sure to properly import them by clicking on **DD Info** and using the **Import DD** button in the Interface Configuration utility.
15. Repeat steps 12–14 for each device.

The second cause for this problem is when the contents of the file do not accurately describe the device characteristics, even if the device identification information matches the file identification information. This problem is caused when a device manufacturer makes a change to the firmware of the device without incrementing the device revision, in violation of the FOUNDATION Fieldbus recommendation. If this is the case, you must contact your device manufacturer for a resolution.

Configuring Advanced Parameters



Caution Do *not* modify the Advanced parameters without good reason. If you must modify parameters for certain devices, the device manufacturer will recommend settings. Modifying these parameters can have an adverse affect on data throughput rates. If settings are incorrectly modified, some devices might disappear off the bus.

In the NI-FBUS Interface Configuration utility, click on the **Advanced** button on the dialog box for the port you want to configure. Figure B-1 shows the **Advanced Stack Configuration** dialog box.

Dlme Master Info	
First Unpolled Node	0x25
Num of Unpolled Node	0xba
Def Min Token Deleg Time	84
Def Token Hold Time	700
Target Token Rot Time	4096
Link Maint Tok Hold Time	0x0
Time Distribution Period	5000

Dlme Basic Info	
Slot Time	5
Max Response Delay	5
Dlpdu Pfl Overhead	0
Min Inter-Pdu Delay	10
Time Sync Class	1 ms

System Management Info	
Device ID:	NIC_AT-FBUS/2_A4A211_0
Primary Time Master	0x10
T1	0x40000
T2	0x40000
T3	0x30000
Clock Sync Interval	10

Figure B-1. Advanced Stack Configuration Dialog Box

The parameters involved in setting addresses are T1 and T3. These parameters represent delay time values that your board uses to compensate for the delays inherent in the device and in the set address protocol itself. T1 describes the expected response delay of the device at a given address. T3 describes the expected time for the device to respond at its new address.

Uninstalling the Software

To uninstall your NI-FBUS software, select **Start»Settings»Control Panel»Add/Remove Programs**.

If you are only using the Communications Manager, select **NI-FBUS Communications Manager** to uninstall. If you are using the NI-FBUS Configurator, select **NI-FBUS Configurator**.

The uninstall utility does not remove the NI-FBUS directory itself or any files in the `\Data\Nvm` directory. To completely uninstall the software, manually remove the files in the `\Data\Nvm` directory and the NI-FBUS directory structure.



Technical Support Resources

Web Support

National Instruments Web support is your first stop for help in solving installation, configuration, and application problems and questions. Online problem-solving and diagnostic resources include frequently asked questions, knowledge bases, product-specific troubleshooting wizards, manuals, drivers, software updates, and more. Web support is available through the Technical Support section of www.ni.com

NI Developer Zone

The NI Developer Zone at ni.com/zone is the essential resource for building measurement and automation systems. At the NI Developer Zone, you can easily access the latest example programs, system configurators, tutorials, technical news, as well as a community of developers ready to share their own techniques.

Customer Education

National Instruments provides a number of alternatives to satisfy your training needs, from self-paced tutorials, videos, and interactive CDs to instructor-led hands-on courses at locations around the world. Visit the Customer Education section of www.ni.com for online course schedules, syllabi, training centers, and class registration.

System Integration

If you have time constraints, limited in-house technical resources, or other dilemmas, you may prefer to employ consulting or system integration services. You can rely on the expertise available through our worldwide network of Alliance Program members. To find out more about our Alliance system integration solutions, visit the System Integration section of www.ni.com

Worldwide Support

National Instruments has offices located around the world to help address your support needs. You can access our branch office Web sites from the Worldwide Offices section of www.ni.com. Branch office web sites provide up-to-date contact information, support phone numbers, e-mail addresses, and current events.

If you have searched the technical support resources on our Web site and still cannot find the answers you need, contact your local office or National Instruments corporate. Phone numbers for our worldwide offices are listed at the front of this manual.

Glossary

Prefix	Meaning	Value
m-	milli-	10^{-3}
k-	kilo-	10^3

A

Alarm	A notification the NI-FBUS Communications Manager software sends when it detects that a block leaves or returns to a particular state.
API	<i>See</i> Application Programmer Interface.
Application	Function blocks.
Application Programmer Interface	A message format that an application uses to communicate with another entity that provides services to it.
Asynchronous	Communication that occurs at times that are not predetermined.
AT-compatible	Compatible with the 16-bit Industry Standard Architecture.

B

Bank	The combination of one FieldPoint network module and one or more terminal bases and I/O modules.
Basic device	A device that can communicate on the Fieldbus, but cannot become the LAS.
Block	A logical software unit that makes up one named copy of a block and the associated parameters its block type specifies. The values of the parameters persist from one invocation of the block to the next. It can be a resource block, transducer block, or function block residing within a virtual field device.
BridgeVIEW	A program for developing applications that require high channel count datalogging, as well as supervisory control of distributed systems.

Bus	The group of conductors that interconnect individual circuitry in a computer. Typically, a bus is the expansion vehicle to which I/O or other devices are connected. Examples of PC busses are the ISA and PCI buses.
Bus scheduler	<i>See</i> Link Active Scheduler.

C

C	Celsius.
Cable	A number of wires and shield in a single sheath.
Capacitor	An electronic component that stores electrical charge. In a computer, capacitors are used in dynamic RAM cells and power supplies.
Channel	A pin or wire lead to which you apply or from which you read the analog or digital signal.
Communication stack	Performs the services required to interface the user application to the physical layer.
Control loop	A set of connections between blocks used to perform a control algorithm.
CPU	Central processing unit.

D

Data Link Layer	The second-lowest layer in the ISO seven-layer model (layer two). The Data Link Layer splits data into frames to send on the physical layer, receives acknowledgment frames, and re-transmits frames if they are not received correctly. It also performs error checking to maintain a sound virtual channel to the next layer.
DD	<i>See</i> Device Description.
Descriptor	A number returned to the application by the NI-FBUS Communications Manager, used to specify a target for future NI-FBUS calls.
Device	A sensor, actuator, or control equipment attached to the Fieldbus.
Device address	A memory address that you use to access a device in a computer system.

Device Description	A machine-readable description of all the blocks and block parameters of a device.
Device ID	An identifier for a device that the manufacturer assigns. No two devices can have the same device ID.
Device tag	A name you assign to a Fieldbus device.
Directory	A structure for organizing files into convenient groups. A directory is like an address showing where files are located. A directory can contain files or subdirectories of files.
DRAM	Dynamic Random Access Memory. Memory that requires electricity and refreshing to hold data.
Driver	Device driver software installed within the operating system.
E	
EMI	Electromagnetic interference.
Event	An occurrence on a device that causes a Fieldbus entity to send the Fieldbus event message.
F	
Field device	A Fieldbus device connected directly to a Fieldbus.
Fieldbus	An all-digital, two-way communication system that connects control systems to instrumentation. A process control local area network defined by ISA standard S50.02.
Fieldbus cable	Shielded, twisted pair cable made specifically for Fieldbus that has characteristics important for good signal transmission and are within the requirements of the Fieldbus standard.
Fieldbus Foundation	An organization that developed a Fieldbus network specifically based upon the work and principles of the ISA/IEC standards committees.
Fieldbus Network Address	Location of a board or device on the Fieldbus; the Fieldbus node address.
FOUNDATION Fieldbus specification	The communications network specification that the Fieldbus Foundation created.
FP-3000	National Instruments network interface module for the FieldPoint I/O system.

Function block	A named block consisting of one or more input, output, and contained parameters. The block performs some control function as its algorithm. Function blocks are the core components you control a system with. The Fieldbus Foundation defines standard sets of function blocks. There are ten function blocks for the most basic control and I/O functions. Manufacturers can define their own function blocks.
Function Block Application	The block diagram that represents your control strategy.

G

Ground	An intentional or accidental conducting path between an electrical system or circuit and the earth or some conducting body acting in place of the earth. A ground is often used as the common wiring point or reference in a circuit.
--------	---

H

H1	The 31.25 kbit/second type of Fieldbus.
HMI	Human-Machine Interface. A graphical user interface for the process with supervisory control and data acquisition capability.

I

IEC	International Electrotechnical Commission. A technical standards committee which is at the same level as the ISO.
in.	Inches.
I/O	Input/output.
IRQ	Interrupt request.
ISA	Industry Standard Architecture.

K

Kbits	Kilobits.
Kernel	The set of programs in an operating system that implements basic system functions.
Kernel mode	The mode in which device drivers run on Windows NT.

L

Link	A FOUNDATION Fieldbus network is made up of devices connected by a serial bus. This serial bus is called a link (also known as a segment).
Link Active Scheduler	The Fieldbus device that is currently controlling access to the Fieldbus. A device that is responsible for keeping a link operational. The LAS executes the link schedule, circulates tokens, distributes time, and probes for new devices.
Link master device	A device that is capable of becoming the LAS
Live list	The list of all devices that are properly responding to the Pass Token.
Lookout	National Instruments Lookout is a full-featured object-based automation software system that delivers unparalleled power and ease of use in demanding industrial measurement and automation applications.
Loop	<i>See</i> control loop.

M

mA	milliamperere.
Mode	Type of communication.

N

Network address	The Fieldbus network address of a device.
Nifb.exe	The NIFB process that must be running in the background for you to use your AT-FBUS or PCMCIA-FBUS interface to communicate between the board and the Fieldbus.
NI-FBUS API	The NI-FBUS Communications Manager.
NI-FBUS Communications Manager	Software shipped with National Instruments Fieldbus interfaces that lets you read and write values. It does not include configuration capabilities.
NI-FBUS Configurator	National Instruments Fieldbus configuration software. With it, you can set device addresses, clear devices, change modes, and read and write to the devices.
NI-FBUS Fieldbus Configuration System	<i>See</i> NI-FBUS Configurator.

NI-FBUS process Process that must be running in the background for you to use your AT-FBUS or PCMCIA-FBUS interface to communicate between the board and the Fieldbus.

O

Object An element of an object dictionary.

OPC OLE for Process Control.

P

Parameter One of a set of network-visible values that makes up a function block.

PC Personal Computer.

Physical Layer The layer of the communication stack that converts digital Fieldbus messages from the communication stack to actual physical signals on the Fieldbus transmission medium and vice versa.

PLC *See* Programmable Logic Controller.

Poll To repeatedly inspect a variable or function block to acquire data.

Programmable Logic
Controller A device with multiple inputs and outputs that contains a program you can alter.

R

Repeater Boost the signals to and from the further link.

Resistor Component made of material that opposes flow of current and therefore has some value of resistance.

Resource block A special block containing parameters that describe the operation of the device and general characteristics of a device, such as manufacturer and device name. Only one resource block per device is allowed.

Roundcard A hardware interface for developing FOUNDATION Fieldbus-compliant devices.

S

s	Seconds.
Segment	<i>See</i> Link.
Server	Device that receives a message request.
Service	Services allow user applications to send messages to each other across the Fieldbus using a standard set of message formats.
Session	A communication path between an application and the NI-FBUS Communications Manager.
Signal	An extension of the IEEE 488.2 standard that defines a standard programming command set and syntax for device-specific operations.
Stack	A set of hardware registers or a reserved amount of memory used for calculations or to keep track of internal operations.

T

Tag	A name you can define for a block, virtual field device, or device.
Terminator	A device used to absorb the signal at the end of a wire.
Trend	A Fieldbus object that allows a device to sample a process variable periodically, then transmit a history of the values on the network.

V

VCR	<i>See</i> Virtual Communication Relationship.
VFD	<i>See</i> Virtual Field Device.