

GETTING STARTED GUIDE

NI 9375

16 DI/16 DO, 30 VDC, 7 μ s Sinking DI, 500 μ s Sourcing DO

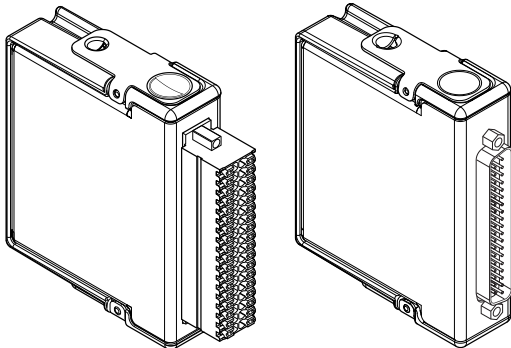

This document explains how to connect to the NI 9375. In this document, the NI 9375 with spring terminal and the NI 9375 with DSUB are referred to inclusively as the NI 9375.



Note Before you begin, complete the software and hardware installation procedures in your chassis documentation.



Note The guidelines in this document are specific to the NI 9375. The other components in the system might not meet the same safety ratings. Refer to the documentation for each component in the system to determine the safety and EMC ratings for the entire system.



Caution Electrostatic Discharge (ESD) can damage the NI 9375 with spring terminal. To prevent damage, use industry-standard ESD prevention measures during installation, maintenance, and operation.

Safety Guidelines

Operate the NI 9375 only as described in this document.



Caution Do not operate the NI 9375 in a manner not specified in this document. Product misuse can result in a hazard. You can compromise the safety protection built into the product if the product is damaged in any way. If the product is damaged, return it to NI for repair.

Safety Voltages

Connect only voltages that are within the following limits:

NI 9375 with Spring Terminal Isolation Voltages

Channel-to-channel	None
Channel-to-earth ground	
Continuous	250 Vrms, Measurement Category II
Withstand up to 4,000 m	3,000 Vrms, verified by a 5 s dielectric withstand test

Measurement Category II is for measurements performed on circuits directly connected to the electrical distribution system. This category refers to local-level electrical distribution, such as

that provided by a standard wall outlet, for example, 115 V for U.S. or 230 V for Europe.



Caution Do not connect the NI 9375 with spring terminal to signals or use for measurements within Measurement Categories III or IV.

NI 9375 with DSUB Isolation Voltages

Channel-to-COM or Vsup-to-COM	30 VDC maximum
----------------------------------	----------------

Isolation

DI bank-to-DO bank	60 VDC maximum
--------------------	----------------

Channel-to-Channel	No isolation between channels
--------------------	-------------------------------

Channel-to-earth ground

Continuous	60 VDC, Measurement Category I
------------	-----------------------------------

Withstand up to 2,000 m	1,000 Vrms, verified by a 5 s dielectric withstand test
----------------------------	--

Measurement Category I is for measurements performed on circuits not directly connected to the electrical distribution system referred to as *MAINS* voltage. MAINS is a hazardous live

electrical supply system that powers equipment. This category is for measurements of voltages from specially protected secondary circuits. Such voltage measurements include signal levels, special equipment, limited-energy parts of equipment, circuits powered by regulated low-voltage sources, and electronics.



Caution Do not connect the NI 9375 with DSUB to signals or use for measurements within Measurement Categories II, III, or IV.



Note Measurement Categories CAT I and CAT O are equivalent. These test and measurement circuits are not intended for direct connection to the MAINS building installations of Measurement Categories CAT II, CAT III, or CAT IV.

Safety Guidelines for Hazardous Locations

The NI 9375 is suitable for use in Class I, Division 2, Groups A, B, C, D, T4 hazardous locations; Class I, Zone 2, AEx nA IIC T4 and Ex nA IIC T4 hazardous locations; and nonhazardous locations only. Follow these guidelines if you are installing the NI 9375 in a potentially explosive environment. Not following these guidelines may result in serious injury or death.



Caution Do not disconnect I/O-side wires or connectors unless power has been switched off or the area is known to be nonhazardous.



Caution Do not remove modules unless power has been switched off or the area is known to be nonhazardous.



Caution Substitution of components may impair suitability for Class I, Division 2.



Caution For Division 2 and Zone 2 applications, install the system in an enclosure rated to at least IP54 as defined by IEC/EN 60079-15.



Caution For Division 2 and Zone 2 applications, install a protection device between any two terminals. The device must prevent the $V_{sup-COM}$ voltage from exceeding 42 V if there is a transient overvoltage condition.

Special Conditions for Hazardous Locations Use in Europe and Internationally

The NI 9375 has been evaluated as Ex nA IIC T4 Gc equipment under DEMKO 07 ATEX 0626664X and is IECEx UL 14.0089X

certified. Each NI 9375 is marked  II 3G and is suitable for use in Zone 2 hazardous locations, in ambient temperatures of $-40\text{ }^{\circ}\text{C} \leq T_a \leq 70\text{ }^{\circ}\text{C}$. If you are using the NI 9375 in Gas Group IIC hazardous locations, you must use the device in an NI chassis that has been evaluated as Ex nC IIC T4, Ex IIC T4, Ex nA IIC T4, or Ex nL IIC T4 equipment.



Caution You must make sure that transient disturbances do not exceed 140% of the rated voltage.



Caution The system shall only be used in an area of not more than Pollution Degree 2, as defined in IEC/EN 60664-1.



Caution The system shall be mounted in an ATEX/IECEx-certified enclosure with a minimum ingress protection rating of at least IP54 as defined in IEC/EN 60079-15.



Caution The enclosure must have a door or cover accessible only by the use of a tool.

Electromagnetic Compatibility Guidelines

This product was tested and complies with the regulatory requirements and limits for electromagnetic compatibility (EMC) stated in the product specifications. These requirements and limits provide reasonable protection against harmful interference when the product is operated in the intended operational electromagnetic environment.

This product is intended for use in industrial locations. However, harmful interference may occur in some installations, when the product is connected to a peripheral device or test object, or if the product is used in residential or commercial areas. To minimize interference with radio and television reception and prevent unacceptable performance degradation, install and use this product in strict accordance with the instructions in the product documentation.

Furthermore, any changes or modifications to the product not expressly approved by National Instruments could void your authority to operate it under your local regulatory rules.



Caution To ensure the specified EMC performance, operate this product only with shielded cables and accessories.



Caution To ensure the specified EMC performance, the length of all I/O cables must be no longer than 30 m (100 ft).

Special Conditions for Marine Applications

Some products are Lloyd's Register (LR) Type Approved for marine (shipboard) applications. To verify Lloyd's Register certification for a product, visit [ni.com/certification](https://www.lloydregister.com/certification) and search for the LR certificate, or look for the Lloyd's Register mark on the product.



Caution In order to meet the EMC requirements for marine applications, install the product in a shielded enclosure with shielded and/or filtered power and input/output ports. In addition, take precautions when designing, selecting, and installing measurement probes and cables to ensure that the desired EMC performance is attained.

Preparing the Environment

Ensure that the environment in which you are using the NI 9375 meets the following specifications.

Operating temperature (IEC 60068-2-1, IEC 60068-2-2)	-40 °C to 70 °C
---	-----------------

Operating humidity (IEC 60068-2-78)	10% RH to 90% RH, noncondensing
--	------------------------------------

Pollution Degree	2
------------------	---

Maximum altitude

For NI 9375 with spring terminal	4,000 m
-------------------------------------	---------

For NI 9375 with DSUB	2,000 m
--------------------------	---------

Indoor use only.



Note Refer to the device datasheet on ni.com/manuals for complete specifications.

NI 9375 Pinout

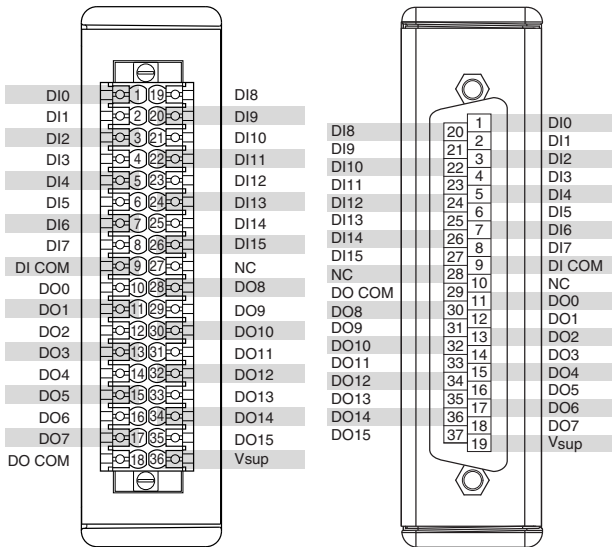
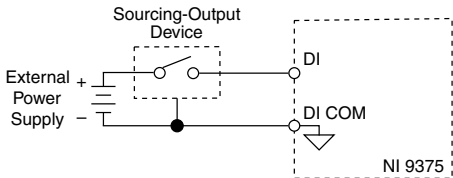

Table 1. Signal Descriptions

Signal	Description
DI	Digital input signal connection
DI COM	Common reference connection for the digital inputs
DO	Digital output signal connection
DO COM	Common reference connection for the digital outputs
NC	No connection
Vsup	Voltage supply connection

Sourcing-Output Connections



The NI 9375 channel registers as ON when the sourcing-output device drives enough current or applies enough voltage to DI. If no device is connected to DI, the channel registers as OFF.

Connecting Digital Devices

You can connect a variety of industrial devices, such as solenoids, motors, actuators, relays, and lamps to the NI 9375. You must connect an external power supply to the NI 9375. The power supply provides the current for the output channels.

Figure 1. Connecting an Industrial Device to the NI 9375

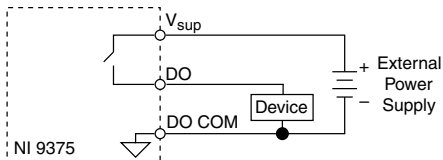

Caution Do not install or remove C Series modules from your system if the external power supply connected to the Vsup and COM pins is powered on.

Ensure that the devices you connect to the NI 9375 are compatible with the output specifications of the NI 9375. Refer to the device datasheet at ni.com/manuals for output specifications.



Note When the industrial device is off, DO is not connected to COM. For large source impedances, you must use a pull-down resistor between DO and COM. Visit ni.com/info and enter the Info Code CSeriesDOPulseGen for more information.

Protecting the Digital Outputs from Flyback Voltages

If the channel is switching an inductive or energy-storing device such as a solenoid, motor, or relay, and the device does not have flyback protection, install an external flyback diode.

Figure 2. Connecting a Flyback Diode

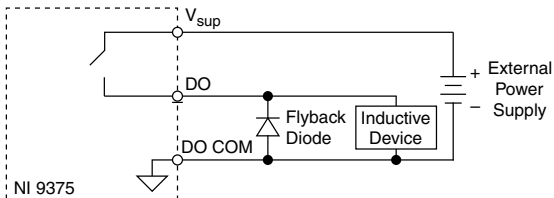

NI 9375 Connection Guidelines

- Make sure that devices you connect to the NI 9375 are compatible with the module specifications.
- You must use 2-wire ferrules to create a secure connection when connecting more than one wire to a single terminal on the NI 9375 with spring terminal.
- For the NI 9375 with spring terminal, push the wire into the terminal when using a solid wire or a stranded wire with a ferrule.
- For the NI 9375 with spring terminal, open the terminal by pressing the push button when using stranded wire without a ferrule.

High-Vibration Application Connections

If your application is subject to high vibration, NI recommends that you use the NI 9940 backshell kit to protect connections to the NI 9375 with spring terminal.

I/O Protection

Each DO channel on the NI 9375 has circuitry that protects it from overcurrents resulting from a short-circuit or faulty loads.



Caution Overvoltage and reverse bias voltage conditions can damage the NI 9375. Check the voltage specifications for all devices that you connect to the NI 9375.

When a short circuit is present on a digital output channel, the DO channel cycles off and on until the short circuit is removed or the current returns to an acceptably low level. An overcurrent state can affect the performance of the NI 9375 and other modules in the system. To ensure safe and proper operation, the digital outputs should not exceed the maximum continuous output current specification.

Where to Go Next

CompactRIO

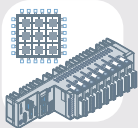

NI 9375 Datasheet



NI-RIO Help



LabVIEW FPGA Help

NI CompactDAQ



NI 9375 Datasheet



NI-DAQmx Help



LabVIEW Help

RELATED INFORMATION



C Series Documentation & Resources

ni.com/info/cseriesdoc



Services

ni.com/services



Located at ni.com/manuals



Installs with the software

Worldwide Support and Services

The NI website is your complete resource for technical support. At ni.com/support, you have access to everything from troubleshooting and application development self-help resources to email and phone assistance from NI Application Engineers.

Visit ni.com/services for NI Factory Installation Services, repairs, extended warranty, and other services.

Visit ni.com/register to register your NI product. Product registration facilitates technical support and ensures that you receive important information updates from NI.

A Declaration of Conformity (DoC) is our claim of compliance with the Council of the European Communities using the manufacturer's declaration of conformity. This system affords the user protection for electromagnetic compatibility (EMC) and product safety. You can obtain the DoC for your product by visiting ni.com/certification. If your product supports calibration, you can obtain the calibration certificate for your product at ni.com/calibration.

NI corporate headquarters is located at 11500 North Mopac Expressway, Austin, Texas, 78759-3504. NI also has offices located around the world. For telephone support in the United States, create your service request at ni.com/support or dial 1 866 ASK MYNI (275 6964). For telephone support outside the United States, visit the *Worldwide Offices* section of ni.com/niglobal to access the branch office websites, which provide up-to-date contact information, support phone numbers, email addresses, and current events.

Refer to the *NI Trademarks and Logo Guidelines* at ni.com/trademarks for information on NI trademarks. Other product and company names mentioned herein are trademarks or trade names of their respective companies. For patents covering NI products/technology, refer to the appropriate location: **Help»Patents** in your software, the `patents.txt` file on your media, or the *National Instruments Patent Notice* at ni.com/patents. You can find information about end-user license agreements (EULAs) and third-party legal notices in the readme file for your NI product. Refer to the *Export Compliance Information* at ni.com/legal/export-compliance for the NI global trade compliance policy and how to obtain relevant HTS codes, ECCNs, and other import/export data. NI MAKES NO EXPRESS OR IMPLIED WARRANTIES AS TO THE ACCURACY OF THE INFORMATION CONTAINED HEREIN AND SHALL NOT BE LIABLE FOR ANY ERRORS. U.S. Government Customers: The data contained in this manual was developed at private expense and is subject to the applicable limited rights and restricted data rights as set forth in FAR 52.227-14, DFAR 252.227-7014, and DFAR 252.227-7015.

© 2017 National Instruments. All rights reserved.