

GETTING STARTED GUIDE

PXIe-5413

20 MHz Bandwidth, 16-Bit PXI Waveform Generator

This document explains how to install, configure, test, and use the PXIe-5413. The PXIe-5413 ships with NI-FGEN driver software, which you can use to program the module.



Note Before you begin, install and configure your chassis and controller.



Caution This icon denotes a caution, which advises you to consult documentation where this symbol is marked.



Caution You can impair the protection provided by the PXIe-5413 if you use it in a manner not described in this document.

Contents

Electromagnetic Compatibility Guidelines.....	2
Verifying the System Requirements.....	2
Unpacking the Kit.....	2
Other Equipment.....	3
Preparing the Environment.....	4
Installing the Software.....	4
Installing the PXIe-5413.....	5
PXIe-5413 Pinout and LEDs.....	6
PXIe-5413 SCB-19 Pinout.....	10
Configuring the PXIe-5413 in MAX.....	11
Self-Calibrating the PXIe-5413.....	12
Generating Waveforms with the NI-FGEN Soft Front Panel.....	12
NI-FGEN Instrument Driver.....	13
Generating Waveforms with NI-FGEN and LabVIEW.....	13
Troubleshooting.....	14
Why Is the ACCESS LED Off When the Chassis Is On?.....	14
What Should I Do if the PXIe-5413 Doesn't Appear in MAX?.....	15
What Should I Do if the PXIe-5413 Fails the Self-Test or Self-Calibration?.....	15
Where to Go Next.....	15
PXIe-5413 Firmware Licensing.....	16
Worldwide Support and Services.....	16

Electromagnetic Compatibility Guidelines

This product was tested and complies with the regulatory requirements and limits for electromagnetic compatibility (EMC) stated in the product specifications. These requirements and limits provide reasonable protection against harmful interference when the product is operated in the intended operational electromagnetic environment.

This product is intended for use in industrial locations. However, harmful interference may occur in some installations, when the product is connected to a peripheral device or test object, or if the product is used in residential or commercial areas. To minimize interference with radio and television reception and prevent unacceptable performance degradation, install and use this product in strict accordance with the instructions in the product documentation.

Furthermore, any changes or modifications to the product not expressly approved by National Instruments could void your authority to operate it under your local regulatory rules.



Caution To ensure the specified EMC performance, operate this product only with shielded cables and accessories.



Caution To ensure the specified EMC performance, the length of all I/O cables must be no longer than 3 m (10 ft).

Verifying the System Requirements

To use the PXIe-5413, your system must meet certain requirements.

For more information about minimum system requirements, recommended system requirements, and supported ADEs, refer to the readme for your selected software support. Readmes are available on the driver software DVD and online at ni.com/updates.

Unpacking the Kit

Refer to the following figure to identify the contents of the PXIe-5413 kit.

Figure 1. PXIe-5413 Kit Contents

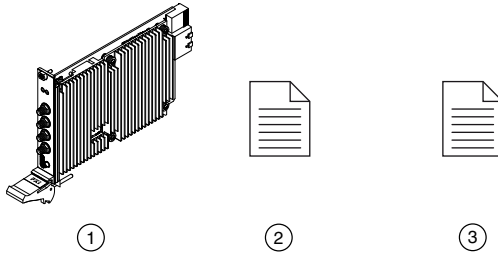

1. PXIe-5413
2. PXIe-5413 Getting Started Guide (this document)
3. Maintain Forced-Air Cooling Note to Users



Caution To prevent electrostatic discharge (ESD) from damaging the module, ground yourself using a grounding strap or by holding a grounded object, such as your computer chassis.

1. Touch the antistatic package to a metal part of the computer chassis.
2. Remove the module from the package and inspect it for loose components or other signs of damage.



Caution Never touch the exposed pins of connectors.



Note Do not install a module if it appears damaged in any way.

3. Unpack any other items and documentation from the kit.

Store the module in the antistatic package when the module is not in use.

Other Equipment

There are several required items not included in your PXIe-5413 kit that you need to operate the PXIe-5413. Your application may require additional items not included in your kit to install or operate your PXIe-5413.

Required Items

- A PXI chassis and chassis documentation
- A PXI controller or PC with a device for PXI remote control system that meets the system requirements specified in this guide and chassis documentation

Optional Items

- PXI slot blocker kit (NI part number 199198-01)
- SCB-19 connector block (NI part number 785642-01)
- SHH19-MH19-AUX shielded single-ended cable, 1 M (NI part number 784091-01)

Visit ni.com for more information about these additional items.

Preparing the Environment

Ensure that the environment you are using the PXIe-5413 in meets the following specifications:

Maximum altitude	2,000 m (800 mbar) (at 25 °C ambient temperature)
Pollution Degree	2
Operating ambient temperature range	0 °C to 55 °C (Tested in accordance with IEC 60068-2-1 and IEC 60068-2-2. Meets MIL-PRF-28800F Class 3 low temperature limit and MIL-PRF-28800F Class 2 high temperature limit.)
Operating relative humidity range	10% to 90%, noncondensing (Tested in accordance with IEC 60068-2-56.)

Indoor use only.

Related Information

[Refer to the PXIe-5413 Specifications at ni.com for complete specifications.](https://ni.com)

Installing the Software

You must be an Administrator to install NI software on your computer.

1. Install an ADE, such as LabVIEW or LabWindows™/CVI™.
2. Visit ni.com/downloads/drivers and search for NI-FGEN.
3. Download the latest version of NI-FGEN by clicking **Download** and then running the executable (.exe) file.
4. Follow the instructions in the installation prompts.



Note Windows users may see access and security messages during installation. Accept the prompts to complete the installation.

5. When the installer completes, select **Restart** in the dialog box that prompts you to restart, shut down, or restart later.

Installing the PXIe-5413



Caution To prevent damage to the PXIe-5413 caused by ESD or contamination, handle the module using the edges or the metal bracket.



Caution Clean the hardware with a soft, nonmetallic brush. Make sure that the hardware is completely dry and free from contaminants before returning it to service.

The PXIe-5413 is a single-slot module with one backplane connector. The module may be installed into any PXI Express-compatible slot.

1. Ensure the AC power source is connected to the chassis before installing the PXIe-5413.

The AC power cord grounds the chassis and protects it from electrical damage while you install the PXIe-5413.

2. Power off the chassis.
3. Inspect the slot pins on the chassis backplane for any bends or damage prior to installation. Do not install a module if the backplane is damaged.
4. Position the chassis so that inlet and outlet vents are not obstructed.

For more information about optimal chassis positioning, refer to the chassis documentation.

5. Remove the black plastic covers from all the captive screws on the module front panel.
6. Identify a supported slot in the chassis. The following figure shows the symbols that indicate the slot types.

Figure 2. Chassis Compatibility Symbols

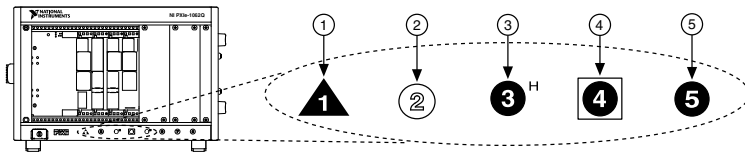

- | | |
|---------------------------------------|-----------------------------------|
| 1. PXI Express System Controller Slot | 4. PXI Express System Timing Slot |
| 2. PXI Peripheral Slot | 5. PXI Express Peripheral Slot |
| 3. PXI Express Hybrid Peripheral Slot | |

PXIe-5413 modules can be placed in PXI Express peripheral slots, PXI Express hybrid peripheral slots, or PXI Express system timing slots.

7. Touch any metal part of the chassis to discharge static electricity.
8. Ensure that the ejector handle is in the downward (unlatched) position.
9. Place the module edges into the module guides at the top and bottom of the chassis. Slide the module into the slot until it is fully inserted.

Figure 3. Module Installation

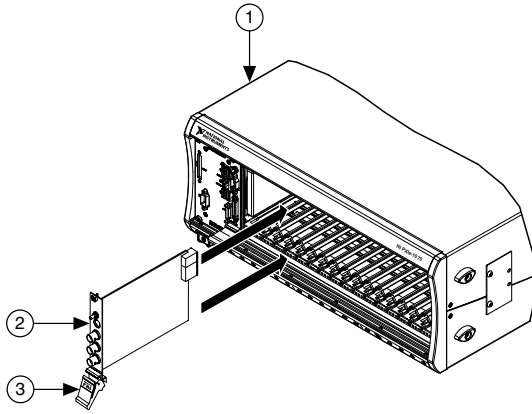

1. Chassis
2. Hardware Module
3. Ejector Handle in Downward (Unlatched) Position

10. Latch the module in place by pulling up on the ejector handle.
11. Secure the module front panel to the chassis using the front-panel mounting screws.



Note Tightening the top and bottom mounting screws increases mechanical stability and also electrically connects the front panel to the chassis, which can improve the signal quality and electromagnetic performance.

12. Cover all empty slots using EMC filler panels or fill using slot blockers to maximize cooling air flow, depending on your application.
13. Power on the chassis.

Related Information

[Why Is the ACCESS LED Off When the Chassis Is On?](#) on page 14

PXle-5413 Pinout and LEDs

Front Panel

Refer to the following figure and tables for information about the one- and two-channel PXle-5413 front panel connectors and LEDs.

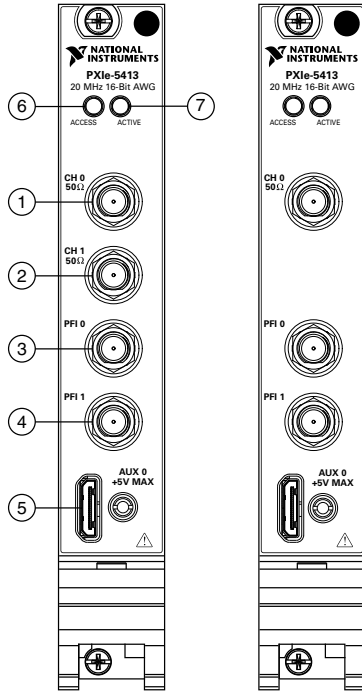

Table 1. PXIe-5413 Signal Descriptions

	Signal	Connector Type	Access	Description
1	CH 0	SMA	Output	Generates waveforms from an analog output terminal.
2	CH 1			
3	PFI 0		Input/Output	Imports digital trigger signals and exports digital event signals. Imported digital trigger signals can start or step through waveform generation, and exported event signals indicate the state of the generation engine.
4	PFI 1			
5	AUX 0	MHDMMR		Routes digital trigger and event signals with eight bidirectional PFI lines and provides a +3.3 V power source.

The ACCESS LED indicates basic hardware status.

Table 2. PXIe-5413 ACCESS LED Indicators

	LED Color	Indication
6	No color (off)	The PXIe-5413 is not yet functional.
	Amber	The PXIe-5413 is being accessed.
	Green	The PXIe-5413 is ready to be programmed by NI-FGEN.

The ACTIVE LED indicates the PXIe-5413 hardware state.

Table 3. PXIe-5413 ACTIVE LED Indicators

	LED Color	Indication
7	No color (off)	The PXIe-5413 is not generating.
	Amber	The PXIe-5413 is armed and waiting for a trigger.
	Green	The PXIe-5413 has received a trigger and is generating a waveform.
	Red	<p>The PXIe-5413 has detected an error. NI-FGEN must access the PXIe-5413 to determine the cause of the error. The LED remains red until the error condition is removed. Example errors include the following:</p> <ul style="list-style-type: none"> Phase-locked loop (PLL) unlocked: The PXIe-5413 has detected an unlocked condition on a previously locked PLL. A PLL that is unlocked while in reset does not show an error. The PXIe-5413 has powered down because the internal temperature exceeded the maximum limit. The over-temperature condition must be corrected and the hardware reset. To reset the hardware, call niFgen Reset Device or niFgen_ResetDevice.¹

AUX 0 Connector



Note The AUX 0 connector accepts a standard, third-party HDMI™ type C cable, but the AUX 0 port is not an HDMI interface and the specified performance of the AUX 0 connector is not guaranteed if a third-party HDMI cable is used. Use NI cable assembly SHH19-MH19-AUX for all AUX 0 connections. Do not connect the AUX 0 port on the PXIe-5413 to the HDMI port of another device. NI is not liable for any damage resulting from such signal connections.

Refer to the following figure and table for information about the PXIe-5413 AUX 0 connector pins.

¹ For more information about keeping the PXIe-5413 within internal temperature limits, refer to the *Maintain Forced-Air Cooling Note to Users* included with your PXIe-5413 and at ni.com.

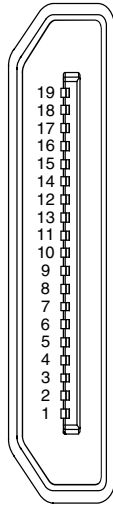

Table 4. AUX 0 Pin Signal Descriptions

Pin	Signal	Description
1	GND	Ground reference for signals
2	NC	No connection
3	GND	Ground reference for signals
4	GND	Ground reference for signals
5	NC	No connection
6	GND	Ground reference for signals
7	GND	Ground reference for signals
8	AUX 0/PFI 0	Bidirectional PFI line
9	AUX 0/PFI 1	Bidirectional PFI line
10	GND	Ground reference for signals
11	AUX 0/PFI 2	Bidirectional PFI line
12	AUX 0/PFI 3	Bidirectional PFI line
13	GND	Ground reference for signals
14	AUX 0/PFI 4	Bidirectional PFI line

Table 4. AUX 0 Pin Signal Descriptions (Continued)

Pin	Signal	Description
15	AUX 0/PFI 5	Bidirectional PFI line
16	AUX 0/PFI 6	Bidirectional PFI line
17	AUX 0/PFI 7	Bidirectional PFI line
18	+3.3 V	+3.3 V power output (200 mA maximum)
19	GND	Ground reference for signals

PXIe-5413 SCB-19 Pinout

NI recommends using the SCB-19 connector block to connect digital signals to the AUX 0 connector on the PXIe-5413 front panel. Refer to the following figure and table for information about the SCB-19 signals when connected to the AUX 0 front panel connector.

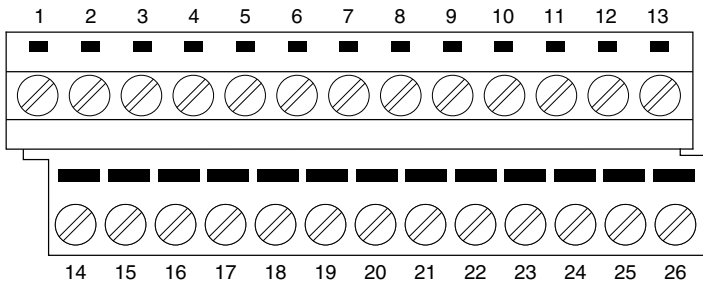

Table 5. SCB-19 Signal Descriptions

Pin	Signal	Description
1	PFI 0	Bidirectional PFI line
2	PFI 1	Bidirectional PFI line
3	PFI 2	Bidirectional PFI line
4	PFI 3	Bidirectional PFI line
5	NC	No connection
6	NC	No connection
7	NC	No connection

Table 5. SCB-19 Signal Descriptions (Continued)

Pin	Signal	Description
8	NC	No connection
9	PFI 4	Bidirectional PFI line
10	PFI 5	Bidirectional PFI line
11	PFI 6	Bidirectional PFI line
12	PFI 7	Bidirectional PFI line
13	+3.3 V	+3.3 V power (200 mA maximum)
<14..26>	GND	Ground reference for signals

Configuring the PXIe-5413 in MAX

Use Measurement & Automation Explorer (MAX) to configure your NI hardware. MAX informs other programs about which NI hardware products are in the system and how they are configured. MAX is automatically installed with NI-FGEN.

1. Launch MAX.
2. In the configuration tree, expand **Devices and Interfaces** to see the list of installed NI hardware.

Installed modules appear under the name of their associated chassis.

3. Expand your **Chassis** tree item.

MAX lists all modules installed in the chassis. Your default names may vary.



Note If you do not see your module listed, press <F5> to refresh the list of installed modules. If the module is still not listed, power off the system, ensure the module is correctly installed, and restart.

4. Record the identifier MAX assigns to the hardware. Use this identifier when programming the PXIe-5413.
5. Self-test the hardware by selecting the item in the configuration tree and clicking **Self-Test** in the MAX toolbar.

The MAX self-test performs a basic verification of hardware resources.

Related Information

[What Should I Do if the PXIe-5413 Doesn't Appear in MAX?](#) on page 15

[What Should I Do if the PXIe-5413 Fails the Self-Test or Self-Calibration?](#) on page 15

Self-Calibrating the PXIe-5413

Self-calibration adjusts the PXIe-5413 for variations in the module environment using an onboard high-precision calibration ADC. Perform a complete self-calibration after the first time you install the PXIe-5413.

1. Install the PXIe-5413 and let it warm up for 15 minutes.



Note Warm up begins when the PXI Express chassis has been powered on and the operating system has completely loaded.

2. Self-calibrate the PXIe-5413 by clicking the **Self-Calibrate** button in MAX or calling niFgen Self Cal or niFgen_SelfCal.

The PXIe-5413 modules are externally calibrated at the factory but you should perform a self-calibration in all of the following situations:

- After first installing the PXIe-5413 in a chassis
- After any module that is in the same chassis as the PXIe-5413 is installed, uninstalled, or moved
- When the PXIe-5413 is in an environment where the ambient temperature varies or the PXIe-5413 temperature has drifted more than ± 5 °C from the temperature at the last self-calibration
- Periodic adjustment for small performance drifts that occur with product aging

Related Information



[What Should I Do if the PXIe-5413 Fails the Self-Test or Self-Calibration?](#) on page 15

Generating Waveforms with the NI-FGEN Soft Front Panel

Complete the following steps to generate a standard waveform or an arbitrary waveform using the NI-FGEN Soft Front Panel (SFP):

1. Launch the NI-FGEN SFP.
2. Verify that the PXIe-5413 appears on the NI-FGEN SFP display.
3. If you are using a two-channel PXIe-5413, choose a channel from the **Channel** list.

To generate waveforms on multiple channels, repeat steps 3 and 4 to load a waveform to each channel.

4. Click one of the following **Mode** buttons and complete the following associated steps to configure your PXIe-5413 for waveform generation:
 - **Standard Function Output** 
 1. Click one of the waveform pattern buttons to choose the type of standard function to produce.
 2. Select a variable to set from the drop-down listbox.
 3. Set the frequency, amplitude, DC offset, phase, or duty cycle using the dial to control the value.
 - **Single Arbitrary Waveform Output** 
 1. Click the **Current Waveform Pattern** button  and then click **Load Waveform from disk**.
The Select File dialog box opens and displays waveform example files.

 **Note** You also can download a waveform by selecting **File»Load New Waveform**.
 2. Choose a waveform file and click **OK**.
The File Load dialog box and Waveform Preview window launch. You can close or minimize the Waveform Preview window.
 3. In the **File Load** dialog box, choose a waveform from the **Waveform** list.
 4. Click **OK**.
5. Click **Run** to start waveform generation.

To optimize the waveform, select **Edit»Device Configuration** and adjust the settings.

NI-FGEN Instrument Driver

You can control your signal generator programmatically using the supplied PXIe-5413 Interchangeable Virtual Instrument (IVI) driver and an ADE.

The NI-FGEN API features a set of operations and attributes that exercise all of the functionality of the PXIe-5413 hardware, including configuration, control, and other model-specific functions.

You can run the NI-FGEN examples to demonstrate basic waveform generator applications. Examples display the functionality of the PXIe-5413 and serve as programming models and building blocks for your own applications. LabVIEW, LabWindows/CVI, C, and .NET examples are located at **Start»All Programs»National Instruments»NI-FGEN»NI-FGEN Examples**.

Generating Waveforms with NI-FGEN and LabVIEW

1. Launch LabVIEW.
2. Select **Help»Find Examples**.

3. Select **Hardware Input and Output»Modular Instruments»NI-FGEN (Signal Generators)»Arbitrary Waveform Generation**.

4. Double-click an example to open it.

The Fgen Basic Arb Waveform example demonstrates how to get started using arbitrary waveform mode.

5. Complete the steps on the block diagram.
6. In the **Resource Name** list, select the device name assigned to the PXIe-5413 in MAX.
7. Click **Run** to start the example program.

Troubleshooting

If an issue persists after you complete a troubleshooting procedure, contact NI technical support or visit ni.com/support.

Why Is the ACCESS LED Off When the Chassis Is On?

The LEDs may not light until the module has been configured in MAX. Before proceeding, verify that the PXIe-5413 appears in MAX.

If the ACCESS LED fails to light after you power on the chassis, a problem may exist with the chassis power rails, a hardware module, or the LED.



Caution Apply external signals only while the PXIe-5413 is powered on. Applying external signals while the module is powered off may cause damage.

1. Disconnect any signals from the module front panels.
2. Power off the chassis.
3. Remove the module from the chassis and inspect it for damage. Do not reinstall a damaged module.
4. Install the module in a different chassis slot from which you removed it.
5. Power on the chassis.



Note If you are using a PC with a device for PXI remote control system, power on the chassis before powering on the computer.

6. Verify that the module appears in MAX.
7. Perform a self-test.

If the ACCESS LED still fails to light and failures continue, contact NI technical support or visit ni.com/support.

Related Information

[PXIe-5413 Pinout and LEDs](#) on page 6

What Should I Do if the PXIe-5413 Doesn't Appear in MAX?

1. In the MAX configuration tree, expand **Devices and Interfaces**.
2. Expand the **Chassis** tree to see the list of installed hardware, and press <F5> to refresh the list.
3. If the module is still not listed, power off the system, ensure that all hardware is correctly installed, and restart the system.
4. Navigate to the Device Manager.

Operating System	Description
Windows 10/8.1	Right-click the Start button, and select Device Manager .
Windows 7	Select Start»Control Panel»Device Manager .

5. Verify the PXIe-5413 appears in the Device Manager.
 - a) Under an NI entry, confirm that a PXIe-5413 entry appears.



Note If you are using a PC with a device for PXI remote control system, under **System Devices**, also confirm that no error conditions appear for the **PCI-to-PCI Bridge**.

- b) If error conditions appear, reinstall NI-FGEN and the PXIe-5413.

What Should I Do if the PXIe-5413 Fails the Self-Test or Self-Calibration?

1. Restart the system.
2. Launch MAX, and perform the self-test or self-calibration again.
3. Power off the chassis.
4. Reinstall the failed module in a different slot.
5. Power on the chassis.
6. Perform the self-test or self-calibration again.

Where to Go Next

Refer to the following figure to locate more information about using the PXIe-5413.

Figure 4. Resources for the PXIe-5413

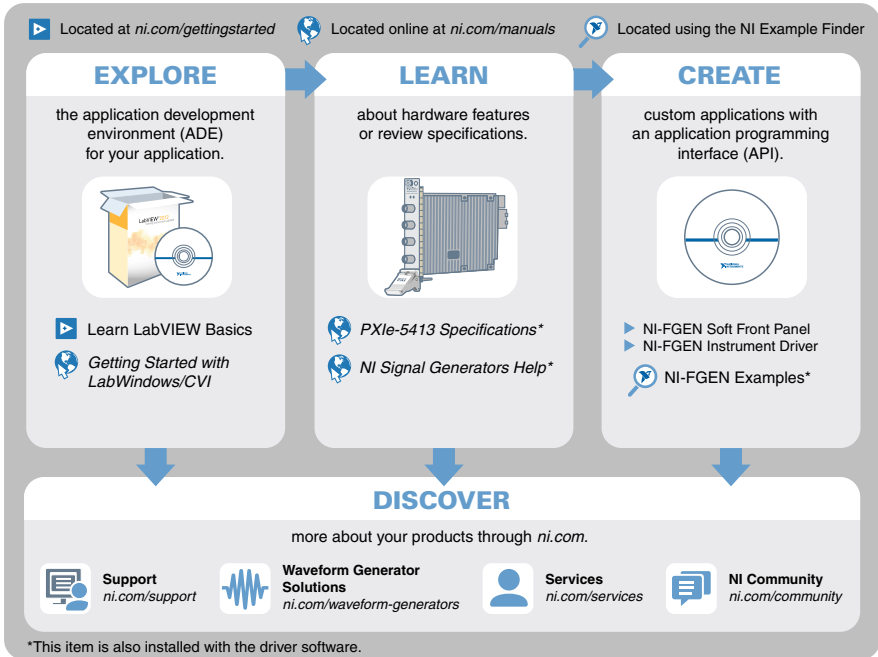

PXIe-5413 Firmware Licensing

Software is licensed pursuant to the software license agreements provided with the software or, in the absence of such license agreements, the National Instruments Software License Agreement available at ni.com/legal at the time of purchase.

For a copy of the software licenses applicable to the firmware for this hardware product, as well as copies of third party licenses and any required notices shipped with the firmware, visit ni.com/info and enter the Info Code `PXIe5413ThirdPartyLicensing`.

Worldwide Support and Services

The NI website is your complete resource for technical support. At ni.com/support, you have access to everything from troubleshooting and application development self-help resources to email and phone assistance from NI Application Engineers.

Visit ni.com/services for NI Factory Installation Services, repairs, extended warranty, and other services.

Visit ni.com/register to register your NI product. Product registration facilitates technical support and ensures that you receive important information updates from NI.

A Declaration of Conformity (DoC) is our claim of compliance with the Council of the European Communities using the manufacturer's declaration of conformity. This system affords the user protection for electromagnetic compatibility (EMC) and product safety. You can obtain the DoC for your product by visiting ni.com/certification. If your product supports calibration, you can obtain the calibration certificate for your product at ni.com/calibration.

NI corporate headquarters is located at 11500 North Mopac Expressway, Austin, Texas, 78759-3504. NI also has offices located around the world. For telephone support in the United States, create your service request at ni.com/support or dial 1 866 ASK MYNI (275 6964). For telephone support outside the United States, visit the *Worldwide Offices* section of ni.com/global to access the branch office websites, which provide up-to-date contact information, support phone numbers, email addresses, and current events.

Information is subject to change without notice. Refer to the *NI Trademarks and Logo Guidelines* at ni.com/trademarks for information on NI trademarks. Other product and company names mentioned herein are trademarks or trade names of their respective companies. For patents covering NI products/technology, refer to the appropriate location: **Help»Patents** in your software, the `patents.txt` file on your media, or the *National Instruments Patent Notice* at ni.com/patents. You can find information about end-user license agreements (EULAs) and third-party legal notices in the `readme` file for your NI product. Refer to the *Export Compliance Information* at ni.com/legal/export-compliance for the NI global trade compliance policy and how to obtain relevant HTS codes, ECCNs, and other import/export data. NI MAKES NO EXPRESS OR IMPLIED WARRANTIES AS TO THE ACCURACY OF THE INFORMATION CONTAINED HEREIN AND SHALL NOT BE LIABLE FOR ANY ERRORS. U.S. Government Customers: The data contained in this manual was developed at private expense and is subject to the applicable limited rights and restricted data rights as set forth in FAR 52.227-14, DFAR 252.227-7014, and DFAR 252.227-7015.

© 2017 National Instruments. All rights reserved.

376719A-01 April 14, 2017