

SPECIFICATIONS

Wireless Test System

Multi-Port Full Duplex RF Communications Test Set

These specifications apply to the following Wireless Test System (WTS), NI-MCT001 options.

- WTS-01 8-port single channel 200 MHz
- WTS-02 8-port dual channel 200 MHz
- WTS-03 8-port dual channel 200 MHz high accuracy clock
- WTS-04 8-port single channel 200 MHz high accuracy clock
- WTS-05 16-port single channel 200 MHz high accuracy clock

Contents

| | |
|--|----|
| Definitions..... | 2 |
| Conditions..... | 3 |
| Frequency..... | 3 |
| Frequency Settling Time..... | 4 |
| Internal Frequency Reference..... | 4 |
| Frequency Reference Input (REF IN)..... | 4 |
| Frequency Reference/Sample Clock Output (REF OUT)..... | 4 |
| Spectral Purity..... | 4 |
| Channel and Port Configuration..... | 5 |
| Signal Analyzer..... | 6 |
| Signal Analyzer Ports..... | 6 |
| Amplitude Range..... | 6 |
| Amplitude Settling Time..... | 6 |
| Absolute Amplitude Accuracy..... | 7 |
| Frequency Response..... | 7 |
| Average Noise Density..... | 10 |
| Spurious Responses..... | 10 |
| LO Residual Power..... | 10 |
| Residual Sideband Image..... | 12 |
| Signal Generator..... | 14 |
| Signal Generator Ports..... | 14 |
| Power Range..... | 14 |
| Amplitude Settling Time..... | 14 |
| Output Power Level Accuracy..... | 14 |
| Frequency Response..... | 16 |
| Output Noise Density..... | 19 |

| | |
|---|----|
| Spurious Responses..... | 19 |
| Third-Order Output Intermodulation..... | 20 |
| P1 dB..... | 20 |
| LO Residual Power..... | 21 |
| Residual Sideband Image..... | 23 |
| Application-Specific Modulation Quality..... | 25 |
| WLAN 802.11ax..... | 25 |
| WLAN 802.11ac..... | 26 |
| WLAN 802.11n..... | 29 |
| WLAN 802.11a/g..... | 30 |
| WLAN 802.11b/g-DSSS..... | 33 |
| Bluetooth (1.0, 2.0, 2.1, 3.0, 4.0, 4.2)..... | 33 |
| LR-WPAN 802.15.4-BPSK/OQPSK (ZigBee)..... | 33 |
| Z-Wave G.9959-FSK/GFSK..... | 34 |
| GSM..... | 34 |
| WCDMA..... | 35 |
| CDMA2K..... | 36 |
| LTE..... | 36 |
| TD-SCDMA..... | 37 |
| Baseband Characteristics..... | 38 |
| Onboard DRAM..... | 38 |
| Hardware Front Panel..... | 38 |
| Front Panel Connectors..... | 39 |
| Port (0..<n>)..... | 39 |
| Power Requirements..... | 44 |
| AC Input..... | 44 |
| Calibration..... | 44 |
| Two Year Calibration Interval Correction Factors..... | 45 |
| Self-Calibration..... | 45 |
| Physical Characteristics..... | 46 |
| Environment..... | 46 |
| Operating Environment..... | 46 |
| Storage Environment..... | 47 |
| Shock and Vibration..... | 47 |
| Compliance and Certifications..... | 47 |
| Safety..... | 47 |
| Electromagnetic Compatibility..... | 47 |
| CE Compliance..... | 48 |
| Online Product Certification..... | 48 |
| Environmental Management..... | 48 |
| Worldwide Support and Services..... | 49 |

Definitions

Warranted specifications describe the performance of a model under stated operating conditions and are covered by the model warranty.

The following characteristic specifications describe values that are relevant to the use of the model under stated operating conditions but are not covered by the model warranty.

- *Typical* specifications describe the performance met by a majority of models.
- *Typical-95* specifications describe the performance met by 95% ($\approx 2\sigma$) of models with a 95% confidence.
- *Nominal* specifications describe an attribute that is based on design, conformance testing, or supplemental testing.

Conditions

Warranted specifications are valid under the following conditions unless otherwise noted.

- 30 minutes warm-up time.
- Calibration cycle is maintained.
- Chassis fan speed is set to High.
- The WTS is configured to use the internal Reference Clock source.



Note Within the specifications, self-calibration ° C refers to the temperature of the last successful self-calibration of the signal analyzer or signal generator connected to the port in use.

Frequency

The following characteristics are common to both signal analyzer and signal generator subsystems.

Frequency range 65 MHz to 6 GHz

Table 1. Bandwidth

| Center Frequency | Instantaneous Bandwidth (MHz) |
|----------------------|-------------------------------|
| 65 MHz to 109 MHz | 20 |
| >109 MHz to <200 MHz | 40 |
| 200 MHz to 6 GHz | 200 |

Tuning resolution 888 nHz

Frequency Settling Time

Table 2. Maximum Frequency Settling Time¹

| Settling Time | Maximum Time (ms) |
|--|-------------------|
| $\leq 1 \times 10^{-6}$ of final frequency | 0.95 |
| $\leq 0.1 \times 10^{-6}$ of final frequency | 1.05 |

Internal Frequency Reference

Table 3. Internal Frequency Reference

| Description | TCXO (WTS-01 or WTS-02) | OCXO (WTS-03, WTS-04, or WTS-05) |
|-----------------------------|--|---|
| Initial adjustment accuracy | 1×10^{-6} | $\pm 70 \times 10^{-9}$ |
| Temperature stability | $\pm 1 \times 10^{-6}$, maximum | $\pm 5 \times 10^{-9}$, maximum |
| Aging | $\pm 1 \times 10^{-6}$ per year, maximum | $\pm 50 \times 10^{-9}$ per year, maximum |
| Accuracy | <i>Initial adjustment accuracy \pm Aging \pm Temperature stability</i> | |

Frequency Reference Input (REF IN)

Refer to the [REF IN](#) section.

Frequency Reference/Sample Clock Output (REF OUT)

Refer to the [REF OUT](#) section.

Spectral Purity

Table 4. Single Sideband Phase Noise

| Frequency | Single Sideband Phase Noise (dBc/Hz), 20 kHz Offset |
|-----------------|---|
| <3 GHz | -99 |
| 3 GHz to 4 GHz | -93 |
| >4 GHz to 6 GHz | -93 |

¹ This specification includes only frequency settling and excludes any residual amplitude settling.

Figure 1. Measured Phase Noise at 900 MHz, 2.4 GHz, and 5.8 GHz

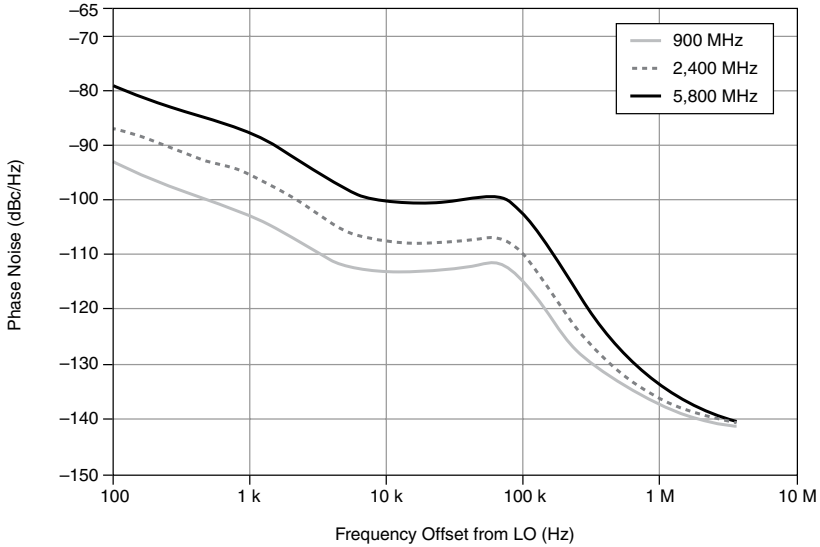

Channel and Port Configuration

You can configure all ports to perform measurement analysis. The software routes the port to a signal analyzer when in use and terminates the port when not in use. When not in use, the RF port is internally terminated to improve channel-to-channel isolation.

You can configure signal generation for broadcast on up to four channels simultaneously. RF ports <0..3> and <4..7> support broadcast generation. The integrated signal generator(s) can drive each group of four channels, as shown in the following figure.

Figure 2. WTS Block Diagram

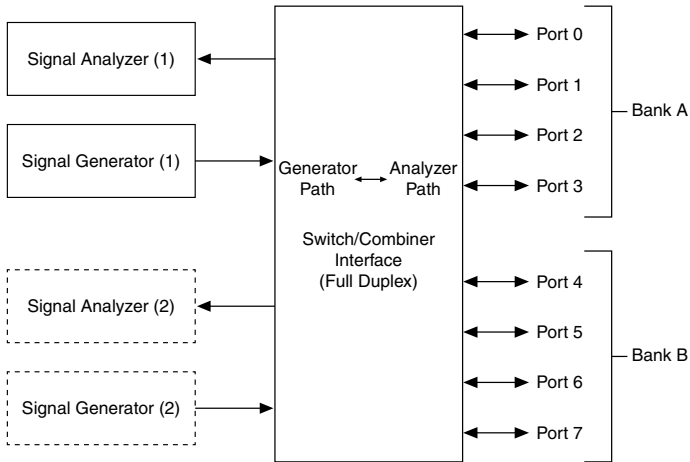

Refer to the *Wireless Test System Instrument Software User Guide*, available at ni.com/manuals, for a block diagram that illustrates the functionality of the WTS.

Signal Analyzer

Signal Analyzer Ports

Number of signal analyzer channel ports 8 or 16

Refer to the [Port \(<0..n>\)](#) section for additional port specifications.

Amplitude Range

| | |
|-------------------------------------|---|
| Amplitude range | Average noise level to +30 dBm (CW RMS) |
| RF reference level range/resolution | ≥60 dB in 1 dB nominal steps |

Amplitude Settling Time

| | |
|---|-----------------|
| <0.1 dB of final value ² | 125 μs, typical |
| <0.5 dB of final value ³ , with LO retuned | 300 μs |
| Port settling time ⁴ | 65 μs, nominal |

² Constant LO frequency, constant RF input signal, varying input reference level.

³ LO tuning across harmonic filter bands, constant RF input signal, varying input reference level.

⁴ The settling that occurs when switching from one active port to another active port.

Absolute Amplitude Accuracy

Table 5. Signal Analyzer Absolute Amplitude Accuracy

| Input Frequency | Absolute Amplitude Accuracy (\pm dB), Self-Calibration $^{\circ}$ C \pm 1 $^{\circ}$ C |
|----------------------------|--|
| 65 MHz to <109 MHz | — |
| \geq 109 MHz to <1.6 GHz | \pm 0.55, typical |
| \geq 1.6 GHz to <4 GHz | 0.45, typical |
| \geq 4 GHz to <5 GHz | 0.65, typical |
| \geq 5 GHz to 6 GHz | 0.60, typical |

Conditions: maximum power level is set from -30 dBm to +30 dBm. For device temperature outside this range, there is an expected temperature coefficient of -0.036 dB/ $^{\circ}$ C for frequencies <4 GHz and -0.055 dB/ $^{\circ}$ C for frequencies \geq 4 GHz.

Frequency Response

Table 6. Signal Analyzer Frequency Response (dB) (Amplitude, Equalized)

| RF Signal Analyzer Frequency | Bandwidth (MHz) | Self-Calibration $^{\circ}$ C \pm 5 $^{\circ}$ C |
|------------------------------|-----------------|--|
| 200 MHz to <2.2 GHz | 80 | 0.6 |
| | 200 | 1.2 |
| 2.2 GHz to 6 GHz | 80 | 0.5 |
| | 200 | 0.9 |

Conditions: maximum power level -30 dBm to +30 dBm. This specification is valid only when the system is operating within the specified ambient temperature range and within the specified range from the last self-calibration temperature, as measured with the onboard temperature sensors.

Frequency response represents the relative flatness within a specified instantaneous bandwidth. Frequency response specifications are valid within any given frequency range and not the LO frequency itself.

Figure 3. Measured 200 MHz Frequency Response, 0 dBm Reference Level, Bank A, Normalized

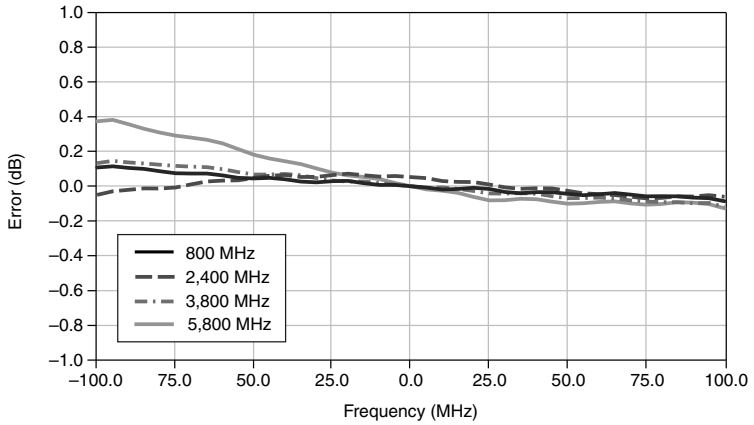

Figure 4. Measured 200 MHz Frequency Response, 0 dBm Reference Level, Bank B, Normalized

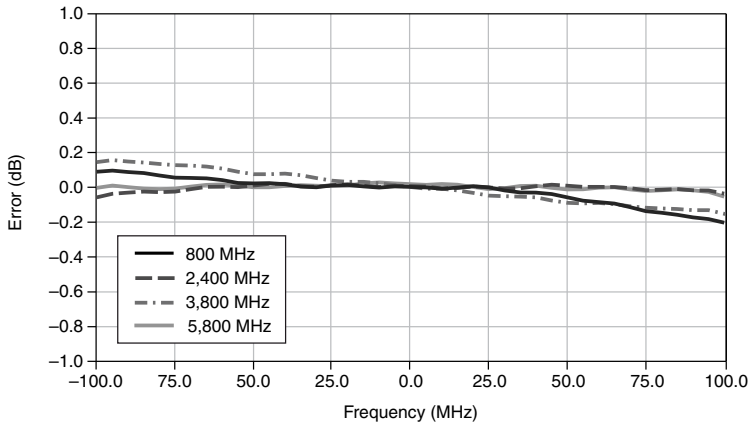

Figure 5. Measured 200 MHz Frequency Response, -30 dBm Reference Level, Bank A, Normalized

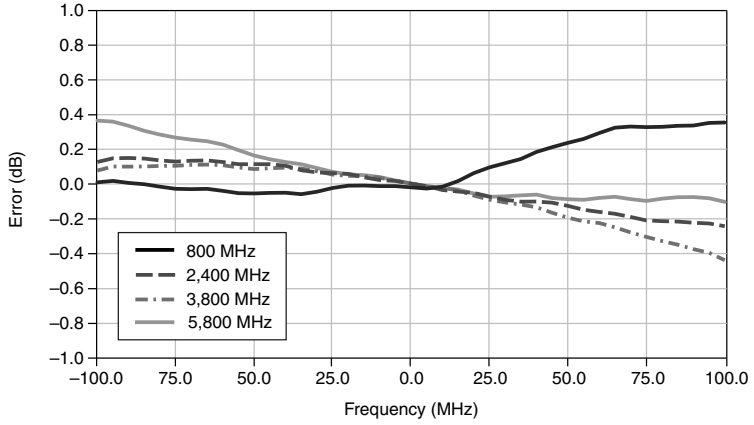
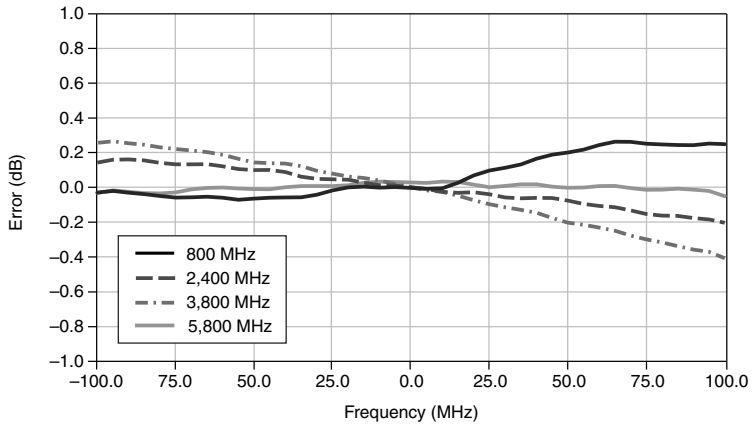

Figure 6. Measured 200 MHz Frequency Response, -30 dBm Reference Level, Bank B, Normalized



Average Noise Density

Table 7. Average Noise Density

| Center Frequency | Average Noise Level (dBm/Hz) | |
|---------------------|------------------------------|-----------------------|
| | -30 dBm Reference Level | 0 dBm Reference Level |
| 80 MHz to <2.2 GHz | -144 | -135 |
| 2.2 GHz to <4.2 GHz | -141 | -134 |
| 4.2 GHz to 6 GHz | -136 | -131 |

Conditions: input terminated with a 50 Ω load; 10 averages; RMS average noise level normalized to a 1 Hz noise bandwidth; noise measured in 1 MHz centered 7.75 MHz from LO frequency.

Spurious Responses

Nonharmonic Spurs

Table 8. Nonharmonic Spurs (dBc)

| Frequency | <100 kHz Offset | ≥100 kHz Offset | >1 MHz Offset |
|-----------------|-----------------|-----------------|---------------|
| 65 MHz to 3 GHz | <-55, typical | <-60 | <-75 |
| >3 GHz to 6 GHz | <-55, typical | <-55 | <-70 |

Conditions: Reference level ≥-30 dBm. Measured with a single tone, -1 dBr, where dBr is referenced to the configured RF reference level.

LO Residual Power

Table 9. Signal Analyzer LO Residual Power

| Center Frequency | LO Residual Power (dBr ⁵) | |
|-------------------|---------------------------------------|----------------------------|
| | Self-Calibration °C ± 1 °C | Self-Calibration °C ± 5 °C |
| ≤109 MHz | -70, typical | -67, typical |
| >109 MHz to 2 GHz | -65, typical | -61, typical |
| >2 GHz to 3 GHz | -60, typical | -58, typical |

⁵ dBr is relative to the full scale of the configured RF reference level.

Table 9. Signal Analyzer LO Residual Power (Continued)

| Center Frequency | LO Residual Power (dBr ⁵) | |
|------------------|---------------------------------------|----------------------------|
| | Self-Calibration °C ± 1 °C | Self-Calibration °C ± 5 °C |
| >3 GHz to 6 GHz | -56, typical | -48, typical |

Conditions: reference levels -30 dBm to +30 dBm; measured at ADC.

For optimal performance, NI recommends running self-calibration when the system temperature drifts ±5 °C from the temperature at the last self-calibration. For temperature changes >±5 °C from self-calibration, LO residual power is -35 dBr.

Figure 7. Signal Analyzer LO Residual Power⁶, Typical

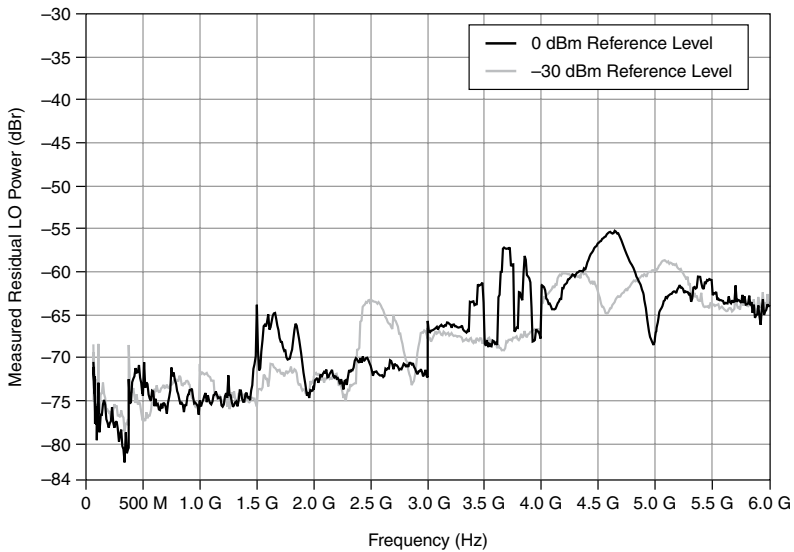

⁵ dBr is relative to the full scale of the configured RF reference level.

⁶ Conditions: Signal analyzer frequency range 109 MHz to 6 GHz. Measurement performed after self-calibration.

Residual Sideband Image

Table 10. Signal Analyzer Residual Sideband Image

| Center Frequency | Bandwidth (MHz) | Residual Sideband Image (dBc) | |
|----------------------|-----------------|-------------------------------|----------------------------|
| | | Self-Calibration °C ± 1 °C | Self-Calibration °C ± 5 °C |
| ≤109 MHz | 20 | -60, typical | -50, typical |
| >109 MHz to <200 MHz | 80 | -50, typical | -45, typical |
| ≥200 MHz to 500 MHz | 200 | -50, typical | -45, typical |
| >500 MHz to 3 GHz | 200 | -75, typical | -67, typical |
| >3 GHz to 6 GHz | 200 | -70, typical | -65, typical |

Conditions: reference levels -30 dBm to +30 dBm.

Frequency response specifications are valid within any given frequency range, not the LO frequency itself.

This specification describes the maximum residual sideband image within a 200 MHz bandwidth at a given RF center frequency. Bandwidth is restricted to 20 MHz for LO frequencies ≤ 109 MHz and restricted to 80 MHz for frequencies > 109 MHz to 200 MHz.

This specification is valid only when the system is operating within the specified ambient temperature range and within the specified range from the last self-calibration temperature, as measured with the onboard temperature sensors.

For optimal performance, NI recommends running self-calibration when the WTS temperature drifts ± 5 °C from the temperature at the last self-calibration. For temperature changes >± 5 °C from self-calibration, residual image suppression is -40 dBc.

Figure 8. Signal Analyzer Residual Sideband Image⁷, 0 dBm Reference Level, Typical

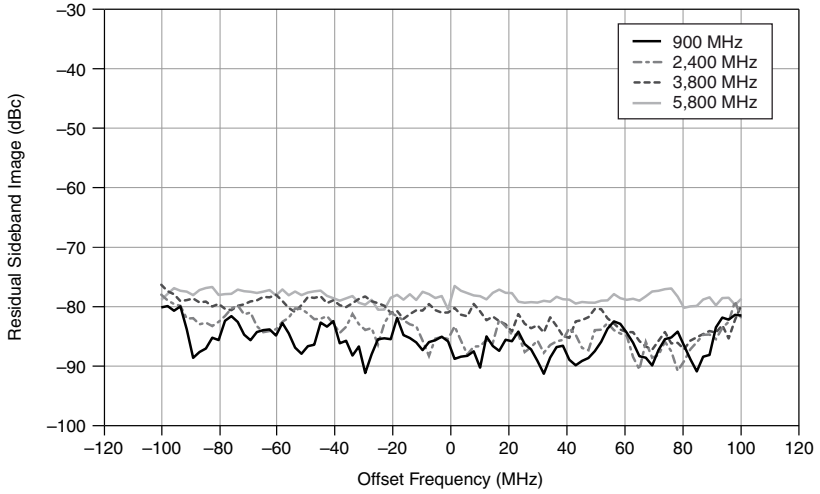
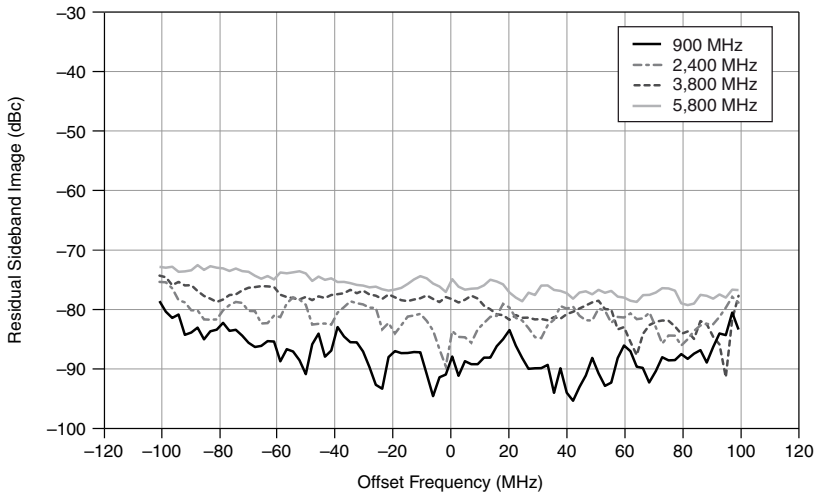

Figure 9. Signal Analyzer Residual Sideband Image⁷, -30 dBm Reference Level, Typical



⁷ Measurement performed after self-calibration.

Signal Generator

Signal Generator Ports

Signal generator ports are designed to broadcast. Any ports that are not configured for output have a significantly attenuated output.

Number of signal generator channel ports 8 or 16

Refer to the [Port \(<0..n>\)](#) section for additional port specifications.

Power Range

CW output power range⁸, 65 MHz to Noise floor to +6 dBm, average power
6 GHz frequency

Amplitude Settling Time

0.1 dB of final value⁹ 50 μ s

0.5 dB of final value¹⁰, with LO retuned 300 μ s

Output Power Level Accuracy

Table 11. Signal Generator Absolute Amplitude Accuracy

| Input Frequency | Signal Generator Absolute Amplitude Accuracy (\pm dB), Self-Calibration $^{\circ}$ C \pm 1 $^{\circ}$ C |
|----------------------------|--|
| 65 MHz to <109 MHz | 0.35, typical |
| \geq 109 MHz to <1.6 GHz | 0.31, typical |
| \geq 1.6 GHz to 4 GHz | 0.40, typical |
| \geq 4 GHz to 5 GHz | 0.50, typical |
| \geq 5 GHz to <5.9 GHz | 0.35, typical |

⁸ Higher output is uncalibrated and may be compressed.

⁹ Constant LO frequency, varying RF output power range. Power levels \leq 0 dBm. 175 μ s for power levels $>$ 0 dBm.

¹⁰ LO tuning across harmonic filter bands.

Table 11. Signal Generator Absolute Amplitude Accuracy (Continued)

| Input Frequency | Signal Generator Absolute Amplitude Accuracy (\pm dB), Self-Calibration $^{\circ}$ C \pm 1 $^{\circ}$ C |
|---|--|
| \geq 5.9 GHz to 6 GHz | 0.35, typical |
| <p>Conditions: signal generator power level set from 0 dBm to -70 dBm.</p> <p>For device temperature outside this range, there is an expected temperature coefficient of -0.036 dB/$^{\circ}$C for frequencies <4 GHz, and -0.055 dB/$^{\circ}$C for frequencies \geq4 GHz.</p> | |

Figure 10. Relative Power Accuracy, -45 dBm to -5 dBm, 5 dB Steps, Measured

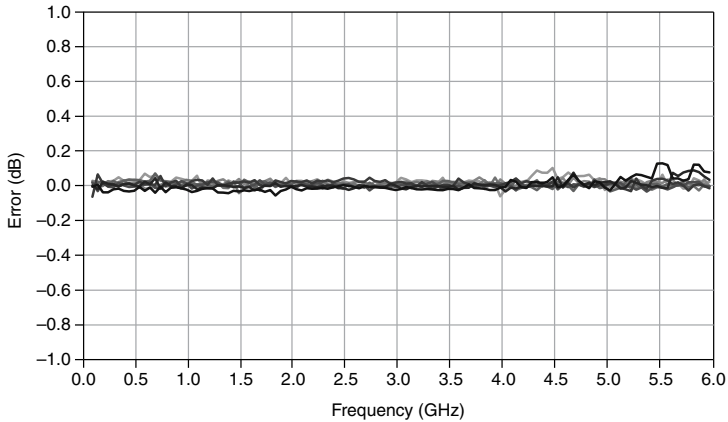

Signal generator port-to-port balance \pm 0.5 dB, \pm 0.25 dB, typical

Figure 11. Intra-Bank Port-to-Port Balance, -10 dB Power Level, Measured

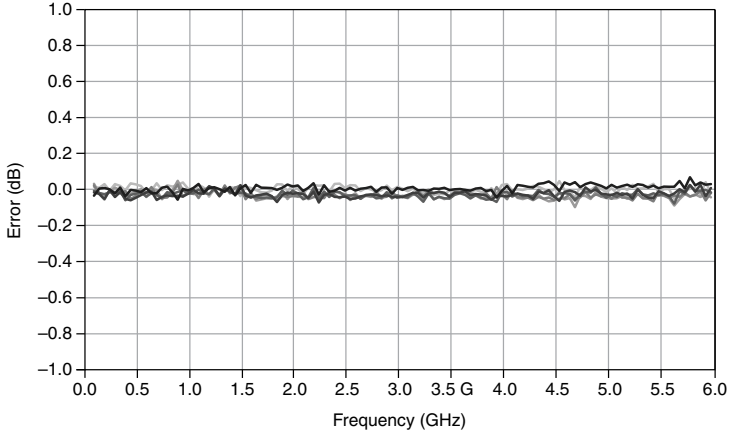
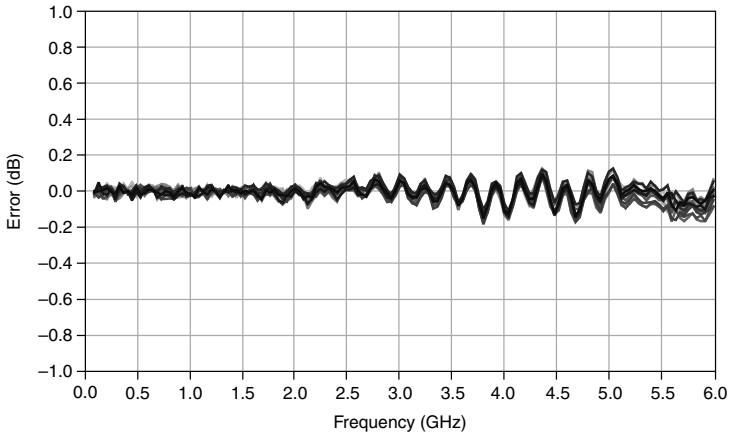

Figure 12. Inter-Bank Port-to-Port Balance, -10 dB Power Level, WTS-01, Measured



Frequency Response

Table 12. Signal Generator Frequency Response (dB) (Amplitude, Equalized)

| Output Frequency | Bandwidth (MHz) | Self-Calibration °C ± 5 °C |
|---------------------|-----------------|----------------------------|
| 200 MHz to <2.2 GHz | 80 | 0.75 |
| | 200 | 1.30 |

Table 12. Signal Generator Frequency Response (dB)
(Amplitude, Equalized) (Continued)

| Output Frequency | Bandwidth (MHz) | Self-Calibration °C ± 5 °C |
|------------------|-----------------|----------------------------|
| 2.2 GHz to 6 GHz | 80 | 1.30 |
| | 200 | 2.20 |

Conditions: Signal generator power level 0 dBm to -30 dBm. This specification is valid only when the system is operating within the specified ambient temperature range and within the specified range from the last self-calibration temperature, as measured with the onboard temperature sensors.

Frequency response represents the relative flatness within a specified instantaneous bandwidth. Frequency response specifications are valid within any given frequency range and not the LO frequency itself.

Figure 13. 200 MHz Frequency Response, 0 dBm Reference Level, Bank A, Normalized, Measured

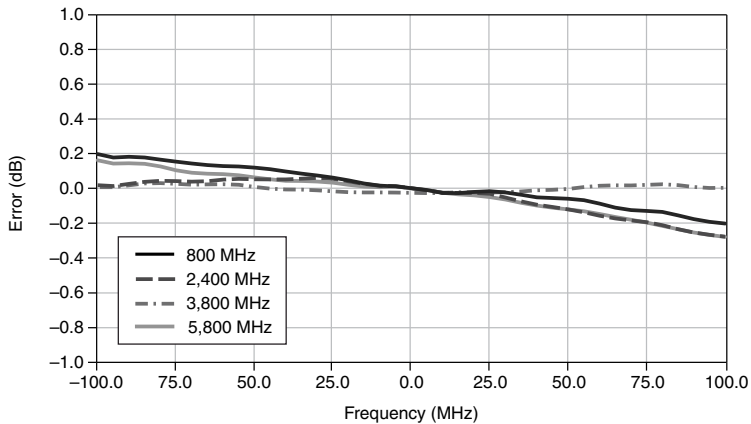

Figure 14. 200 MHz Frequency Response, 0 dBm Reference Level, Bank B, Normalized, Measured

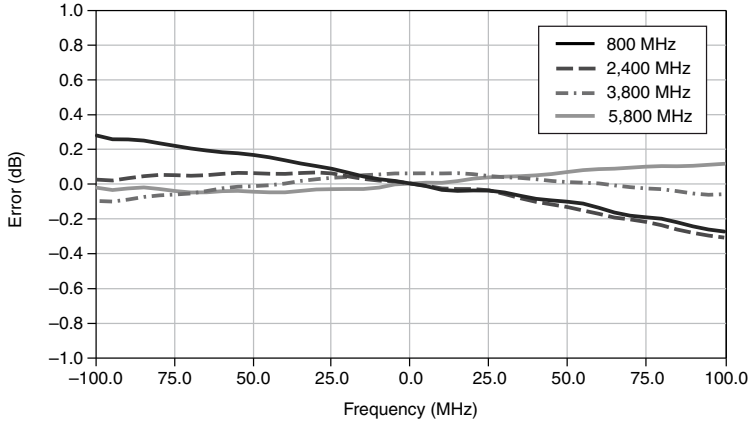

Figure 15. 200 MHz Frequency Response, -20 dBm Reference Level, Bank A, Normalized, Measured

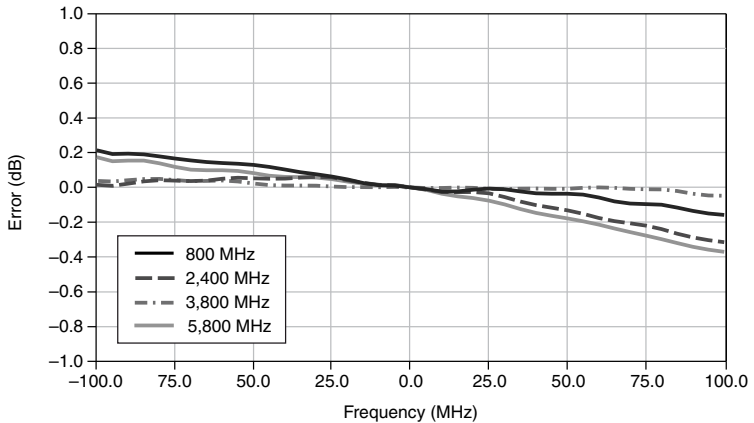
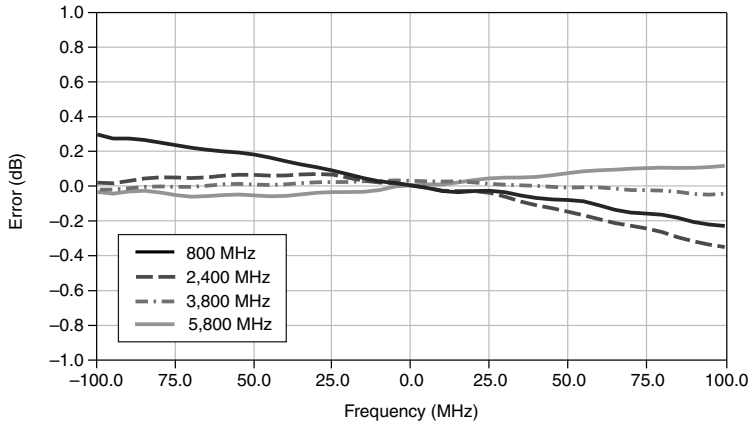

Figure 16. 200 MHz Frequency Response, -20 dBm Reference Level, Bank B, Normalized, Measured



Output Noise Density

Table 13. Average Output Noise Level

| Center Frequency | Average Output Noise Level (dBm/Hz) | |
|---------------------|--|--------------------------------------|
| | Signal Generator Power Level (-10 dBm) | Signal Generator Power Level (0 dBm) |
| 250 MHz to <2.2 GHz | -147 | -143 |
| 2.2 GHz to 6 GHz | -148 | -139 |

Conditions: averages: 10; baseband signal attenuation: -40 dB; output tone frequency 3.75 MHz from LO frequency; noise measured in 1 MHz around 7.75 MHz from LO frequency.

Spurious Responses

Harmonics

Table 14. Second Harmonic Level (dBc)

| Fundamental Frequency | Signal Generator Power Level (-10 dBm) |
|-----------------------|--|
| 80 MHz to <2.2 GHz | -40 |
| 2.2 GHz to 6 GHz | -28 |

Nonharmonic Spurs

Table 15. Nonharmonic Spurs (dBc)

| Frequency | Nonharmonic Spurs (dBc) | | |
|-----------------|-------------------------|-----------------|---------------|
| | <100 kHz Offset | ≥100 kHz Offset | >1 MHz Offset |
| 65 MHz to 3 GHz | <-55, typical | <-62, typical | <-75, typical |
| >3 GHz to 6 GHz | <-55, typical | <-57, typical | <-70, typical |

Conditions: output full scale level ≥-30 dBm; measured with a single tone at -1 dBFS.

Third-Order Output Intermodulation

Table 16. Third-Order Output Intermodulation Distortion (IMD₃)

| Fundamental Frequency | IMD ₃ (dBc) | |
|-----------------------|------------------------|-------------|
| | -20 dBm Tones | 0 dBm Tones |
| 200 MHz to <2.2 GHz | -53 | -31 |
| 2.2 GHz to 6 GHz | -43 | -23 |

Conditions: output full scale level ≥-30 dBm; measured with a single tone at -1 dBFS.

P1 dB

Figure 17. Measured P1 dB Gain Compression, Typical

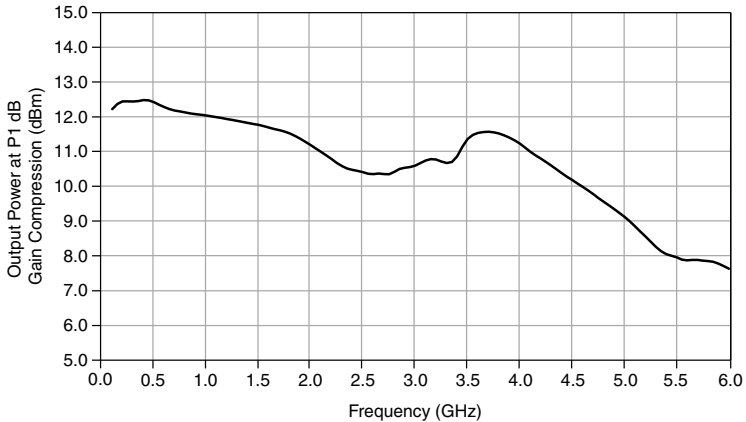

LO Residual Power

Table 17. Signal Generator LO Residual Power (dBc)

| Center Frequency | LO Residual Power (dBc) | |
|---------------------|----------------------------|----------------------------|
| | Self-Calibration °C ± 1 °C | Self-Calibration °C ± 5 °C |
| ≤109 MHz | -60, typical | -49, typical |
| >109 MHz to 200 MHz | -65, typical | -50, typical |
| >200 MHz to 2 GHz | -67, typical | -60, typical |
| >2 GHz to 3 GHz | -60, typical | -53, typical |
| >3 GHz to 5 GHz | -65, typical | -58, typical |
| >5 GHz to 6 GHz | -60, typical | -55, typical |

Conditions: configured power levels -50 dBm to +10 dBm.

This specification is valid only when the system is operating within the specified ambient temperature range and within the specified range from the last self-calibration temperature, as measured with the onboard temperature sensors.

For optimal performance, NI recommends running self-calibration when the WTS temperature drifts ±5 °C from the temperature at the last self-calibration. For temperature changes >±5 °C from self-calibration, LO residual power is -40 dBc.

Figure 18. Signal Generator LO Residual Power⁷, 109 MHz to 6 GHz, Typical

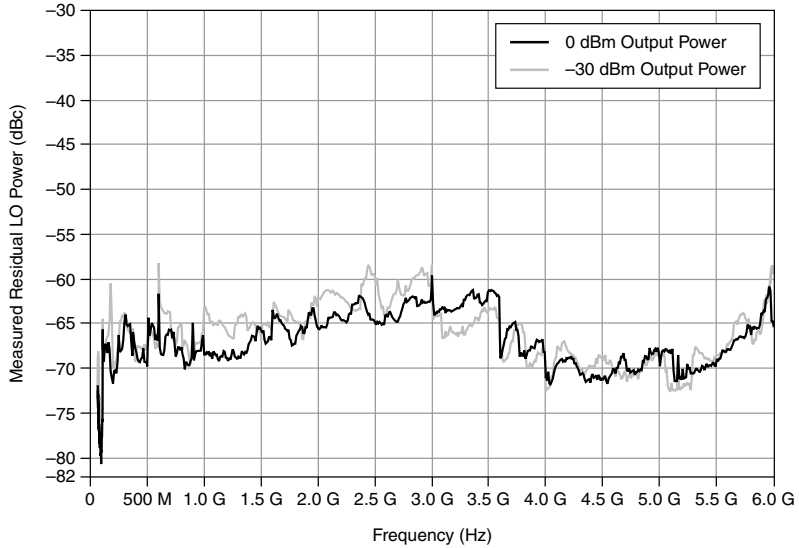

Table 18. Signal Generator LO Residual Power (dBc), Low Power

| Center Frequency | Self-Calibration °C ± 5 °C |
|---------------------|----------------------------|
| ≤109 MHz | -49, typical |
| >109 MHz to 375 MHz | -50, typical |
| >375 MHz to 2 GHz | -60, typical |
| >2 GHz to 3 GHz | -53, typical |
| >3 GHz to 5 GHz | -58, typical |
| >5 GHz to 6 GHz | -55, typical |

Conditions: configured power levels < -50 dBm to -70 dBm.

This specification is valid only when the system is operating within the specified ambient temperature range and within the specified range from the last self-calibration temperature, as measured with the onboard temperature sensors.

For optimal performance, NI recommends running self-calibration when the system temperature drifts ±5 °C from the temperature at the last self-calibration. For temperature changes ≥±5 °C from self-calibration, LO residual power is -40 dBc.

Residual Sideband Image

Table 19. Signal Generator Residual Sideband Image

| Center Frequency | Bandwidth (MHz) | Residual Sideband Image (dBc) | |
|---------------------|-----------------|-------------------------------|---------------------------|
| | | Self-Calibration °C ± 1°C | Self-Calibration °C ± 5°C |
| ≤109 MHz | 20 | -55, typical | -42, typical |
| >109 MHz to 200 MHz | 80 | -45, typical | -40, typical |
| >200 MHz to 500 MHz | 200 | -45, typical | -50, typical |
| >500 MHz to 2 GHz | 200 | -70, typical | -63, typical |
| >2 GHz to 6 GHz | 200 | -65, typical | -55, typical |

Conditions: reference levels -30 dBm to +30 dBm.

This specification describes the maximum residual sideband image within a 200 MHz bandwidth at a given RF center frequency. Bandwidth is restricted to 20 MHz for LO frequencies ≤109 MHz.

This specification is valid only when the system is operating within the specified ambient temperature range and within the specified range from the last self-calibration temperature, as measured with the onboard temperature sensors.

For optimal performance, NI recommends running self-calibration when the system temperature drifts ±5 °C from the temperature at the last self-calibration. For temperature changes >±5 °C from self-calibration, residual image suppression is -40 dBc.

Figure 19. Signal Generator Residual Sideband Image⁷, 0 dBm Average Output Power, Typical

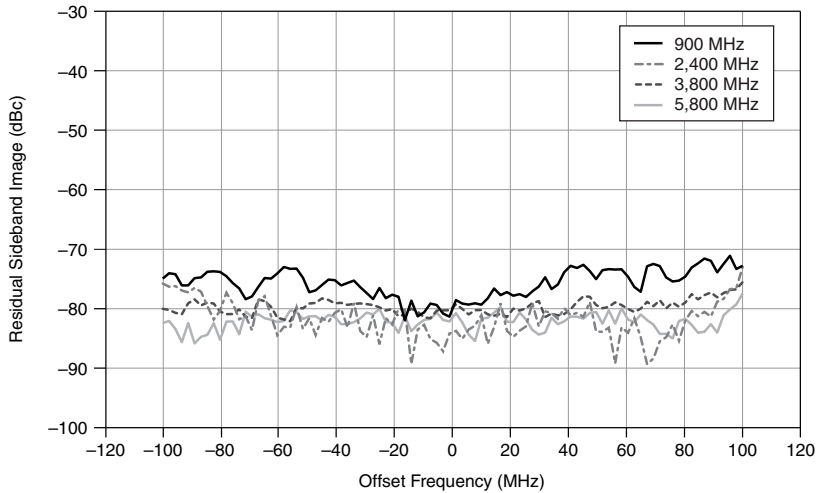
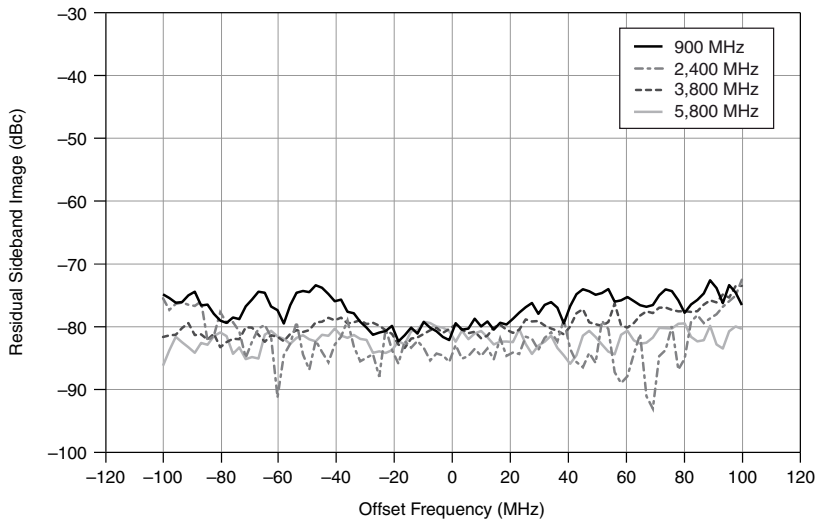

Figure 20. Signal Generator Residual Sideband Image⁷, -30 dBm Average Output Power, Typical



Application-Specific Modulation Quality

Typical performance assumes the WTS is operating within $\pm 5\text{ }^{\circ}\text{C}$ of the previous self-calibration temperature and that the ambient temperature is $0\text{ }^{\circ}\text{C}$ to $50\text{ }^{\circ}\text{C}$.



Note Support for standards depends on the version of WTS Software that your application is using.

WLAN 802.11ax

802.11ax Signal generator residual EVM (bandwidth: 80 MHz)¹¹

| | |
|---------------------------|-----------------|
| Channel tracking disabled | -44 dB, nominal |
| Channel tracking enabled | -46 dB, nominal |

Table 20. 802.11ax Signal Analyzer EVM

| Bandwidth (MHz) | 802.11ax Signal Analyzer Residual EVM (dB) | |
|-------------------------|--|--------------------------|
| | Channel Tracking Disabled | Channel Tracking Enabled |
| 80, noise uncompensated | -44, nominal | -46, nominal |
| 80, noise compensated | -46, nominal | — |

Conditions: Port<n> to RF OUT of PXIe-5840 + external LO; 80 MHz; 5,800 MHz; average power: -10 dBm to +20 dBm; EVM averaged over 20 packets; 16 OFDM data symbols; MCS = 11; 1,024 QAM.

¹¹ Conditions: Port <n> to RF IN of PXIe-5840 + external LO; 80 MHz; 5,800 MHz; average power -30 dBm to -20 dBm; EVM averaged over 20 packets; 16 OFDM data symbols; MCS = 11; 1,024 QAM.

Figure 21. 802.11ax RMS EVM versus Measured Average Power, 80 MHz Bandwidth, Nominal

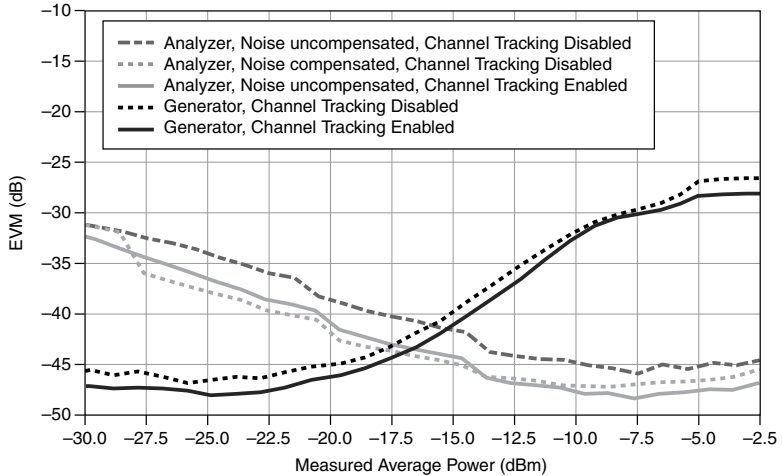

WLAN 802.11ac

Table 21. 802.11ac Signal Generator EVM

| Bandwidth (MHz) | 802.11ac Signal Generator EVM (dB) | |
|-----------------|------------------------------------|--------------------------|
| | Channel Tracking Disabled | Channel Tracking Enabled |
| 80 | -36, typical | -39, typical |
| 160 | -34.5, typical | -38.5, typical |

Conditions: Port<n> to RF IN of PXIe-5645; 5,180 MHz; average power: -36 dBm to -10 dBm; EVM averaged over 50 packets; power averaged over 10 packets; 16 OFDM data symbols; MCS = 9.

Table 22. 802.11ac Signal Analyzer EVM

| Bandwidth (MHz) | 802.11ac Signal Analyzer EVM (dB) | |
|-----------------|-----------------------------------|--------------------------|
| | Channel Tracking Disabled | Channel Tracking Enabled |
| 80 | -38, typical | -41.5, typical |
| 160 | -35, typical | -39, typical |

Conditions: Port<n> to RF OUT of PXIe-5645; 5,180 MHz; average power: -20 dBm to 0 dBm; EVM averaged over 50 packets; power averaged over 10 packets; 16 OFDM data symbols; MCS = 9.

Figure 22. 802.11ac RMS EVM Versus Measured Average Power¹², 80 MHz Bandwidth, Typical

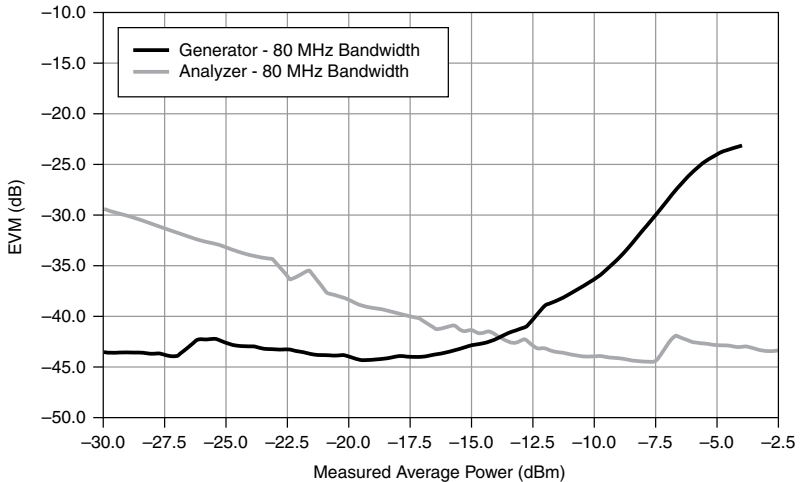

¹² Conditions: Generator = Port<n> to RF IN of PXIe-5645; analyzer = Port<n> to RF OUT of PXIe-5645; 5,180 MHz; analyzer maximum power 10 dB above generator power level; EVM averaged over 50 packets; power averaged over 10 packets; 16 OFDM data symbols; MCS = 9.

Figure 23. 802.11ac RMS EVM Versus Measured Average Power¹²,
160 MHz Bandwidth, Typical

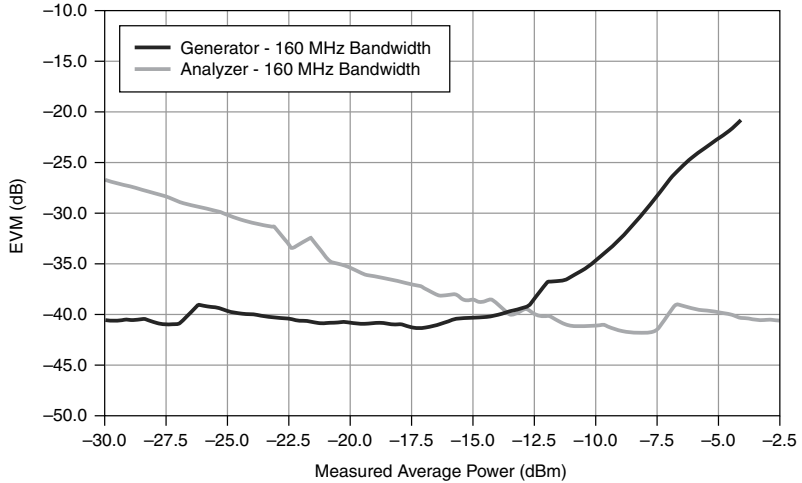
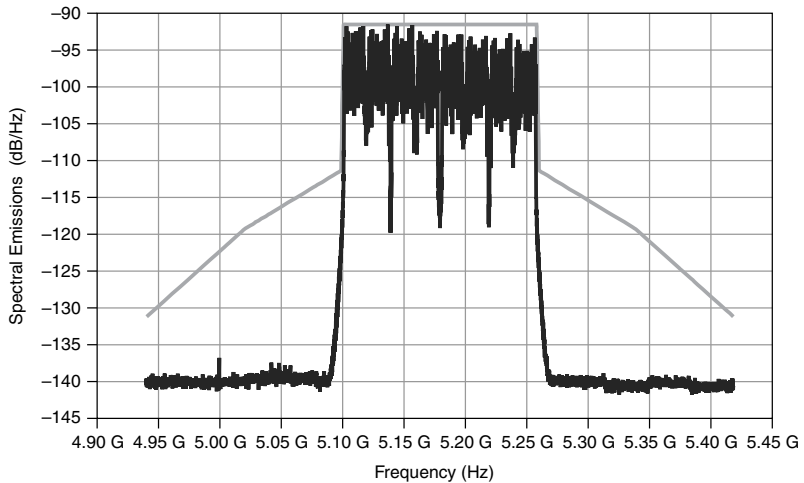

Figure 24. 802.11ac Spectral Emissions Spectrum and Mask¹³, Measured



¹³ Conditions: Port<n> to Port<n>; generator average power: -16 dBm; maximum input power: -6 dBm; 160 MHz bandwidth; EVM averaged over 50 packets; power averaged over 10 packets; 16 OFDM data symbols; MCS = 9.

WLAN 802.11n

Table 23. 802.11n OFDM EVM (rms)

| Frequency (MHz) | 802.11n OFDM EVM (rms) (dB) | |
|-----------------|-----------------------------|------------------|
| | 20 MHz Bandwidth | 40 MHz Bandwidth |
| 2,412 to 2,484 | -48, typical | -47, typical |
| 4,915 to 5,825 | -42, typical | -42, typical |

Conditions: Port<n> into PXIe-5646; generator average power: -16 dBm; maximum input power -6 dBm; 5 packets; MCS = 7.

Figure 25. 802.11n RMS EVM Versus Measured Average Power¹⁴, Typical

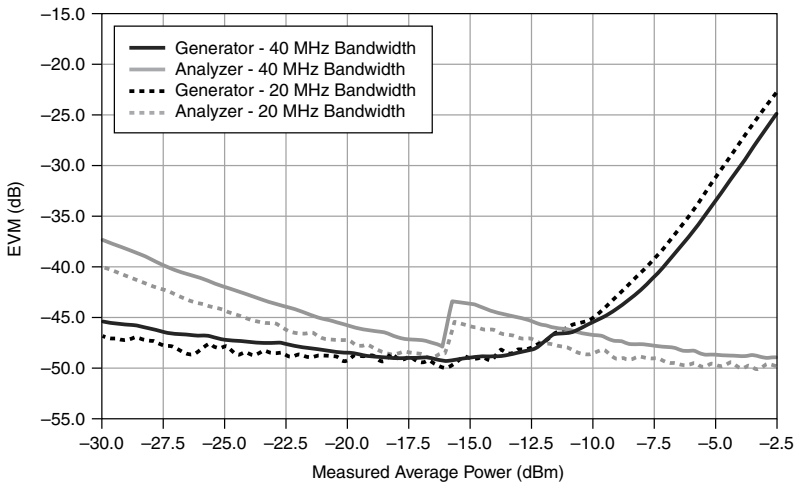

¹⁴ Conditions: Generator = Port<n> to RF IN of PXIe-5646; analyzer = Port<n> to RF OUT of PXIe-5646; 2,412 MHz; analyzer maximum power 10 dB above generator power level; EVM averaged over 50 packets; power averaged over 10 packets; 16 OFDM data symbols; MCS = 7.

Figure 26. 802.11n RMS EVM Versus Measured Average Power¹⁴, Channel Tracking Enabled, Typical

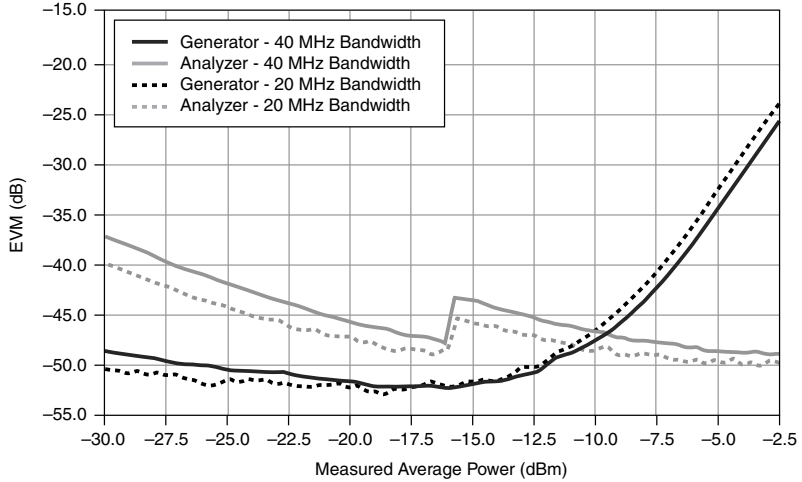

WLAN 802.11a/g

Table 24. 802.11a/g OFDM EVM (rms) (dB)

| Frequency (MHz) | 20 MHz Bandwidth |
|---|------------------|
| 2,412 to 2,484 | -50, typical |
| 4,915 to 5,825 | -44, typical |
| Conditions: Port<n> into PXIe-5646; generator average power: -16 dBm; maximum input power -6 dBm; 5 packets; data rate = 54 MBps. | |

Spectrum flatness¹⁵

| | |
|------------------------|---------------|
| 2.4 GHz frequency band | 4 dB, typical |
| 5 GHz frequency band | 4 dB, typical |

¹⁵ Conditions: Port<n> into PXIe-5646; generator average power: -16 dBm; maximum input power -6 dBm; 5 packets; data rate = 54 MBps.

Figure 27. 802.11a/g RMS EVM Versus Measured Average Power¹⁶, 2,412 MHz, Typical

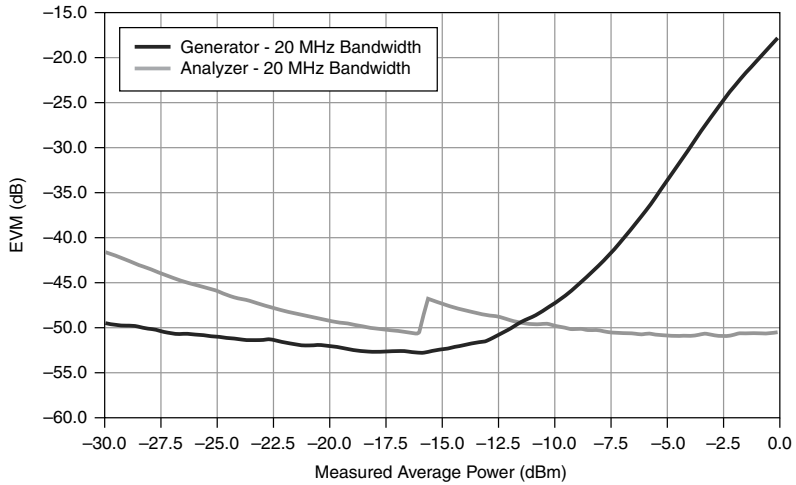
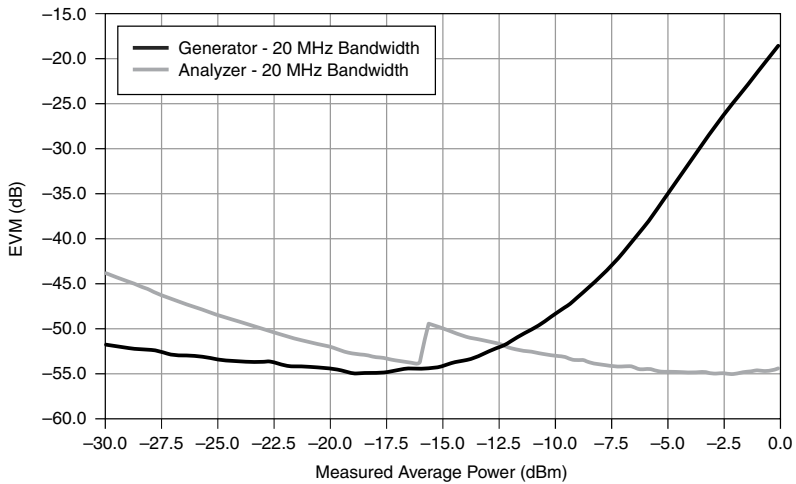

Figure 28. 802.11a/g RMS EVM Versus Measured Average Power¹⁶, 2,412 MHz, Channel Tracking Enabled, Typical



¹⁶ Conditions: Generator = Port<n> to RF IN of PXIe-5646; analyzer = Port<n> to RF OUT of PXIe-5646; 2,412 MHz; analyzer maximum power 10 dB above generator power level; EVM averaged over 50 packets; power averaged over 10 packets; 16 OFDM data symbols; data rate = 54 MBps.

Figure 29. 802.11a/g RMS EVM Versus Measured Average Power¹⁷, 5,810 MHz, Typical

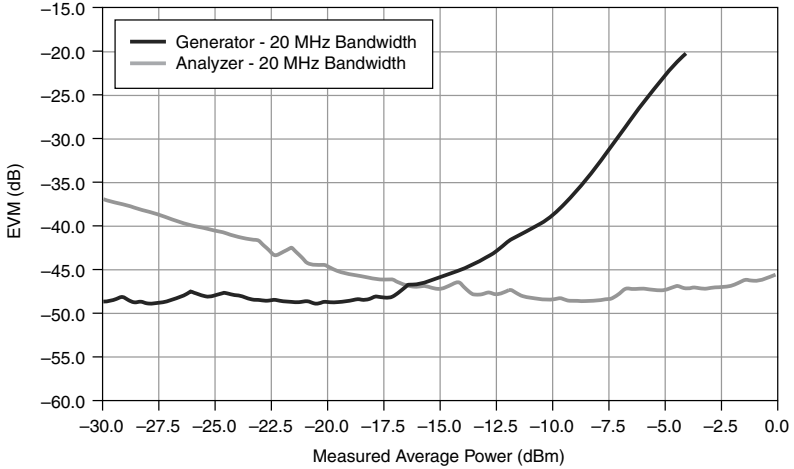
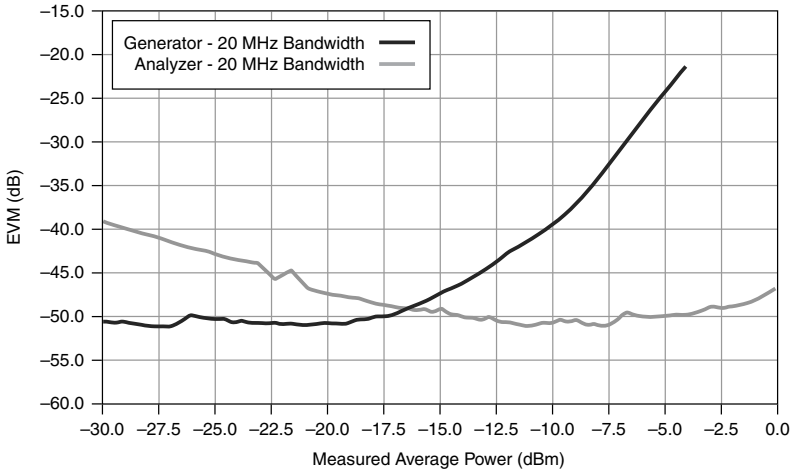

Figure 30. 802.11a/g RMS EVM Versus Measured Average Power¹⁷, 5,810 MHz, Channel Tracking Enabled, Typical



¹⁷ Conditions: Generator = Port<n> to RF IN of PXIe-5646; analyzer = Port<n> to RF OUT of PXIe-5646; 5,810 MHz; analyzer maximum power 10 dB above generator power level; EVM averaged over 50 packets; power averaged over 10 packets; 16 OFDM data symbols; data rate = 54 MBps.

WLAN 802.11b/g-DSSS

802.11b DSSS EVM¹⁸ (rms), 20 MHz bandwidth

2,412 MHz to 2,484 MHz

0.53%, typical

Figure 31. 802.11b RMS EVM Versus Measured Average Power¹⁹, Typical

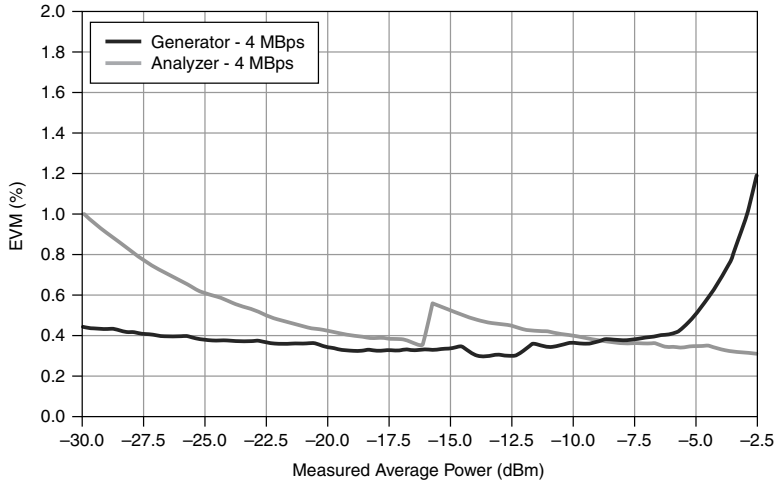

Bluetooth²⁰ (1.0, 2.0, 2.1, 3.0, 4.0, 4.2)

In-band emissions (adjacent channel) -59 dBc, typical

Average DEVM RMS, enhanced data rate (EDR) 0.4%, typical

Peak DEVM (EDR) 1.2%, typical

LR-WPAN 802.15.4-BPSK/OQPSK (ZigBee)

Output power SA accuracy ± 0.45 dB to 0.65 dB, nominal

Power spectral density SA accuracy ± 0.45 dB to 0.65 dB, nominal

¹⁸ Conditions: Port<n> into PXIe-5646; generator average power: -16 dBm; maximum input power -6 dBm; 5 packets; data rate = 2 MBps.

¹⁹ Conditions: Generator = Port<n> to RF IN of PXIe-5646; analyzer = Port<n> to RF OUT of PXIe-5646; 2,412 MHz; analyzer maximum power 10 dB above generator power level; EVM averaged over 50 packets; power averaged over 5 packets; 16 OFDM data symbols; data rate = 2 MBps.

²⁰ Conditions: Port<n> loopback to Port<n>; 3-DH5 packet; 2,400 MHz to 2,483.5 MHz; generator power level -12 dBm; analyzer maximum power level -10 dBm.

| | |
|----------------------------|---|
| Occupied bandwidth | SA accuracy \pm 0.45 dB to 0.65 dB, nominal |
| Center frequency tolerance | SA accuracy \pm 0.125 ppm (OCXO) |
| EVM ²¹ | 0.5%, nominal |
| Offset EVM ²² | 0.5%, nominal |

Z-Wave G.9959-FSK/GFSK

| | |
|---|---|
| Output power | SA accuracy \pm 0.45 dB to 0.65 dB, nominal |
| Spectrum emission mask | SA accuracy \pm 0.45 dB to 0.65 dB, nominal |
| Occupied bandwidth | SA accuracy \pm 0.45 dB to 0.65 dB, nominal |
| Frequency error | SA accuracy \pm 0.125 ppm (OCXO) |
| Frequency deviation error ²³ | 0.6%, nominal |

GSM

| | |
|---------------------------|----------------|
| Phase error ²⁴ | |
| Peak phase error (GMSK) | 0.70°, typical |
| RMS phase error (GMSK) | 0.25°, typical |
| EDGE EVM ²⁵ | |
| EDGE RMS EVM | 0.35°, typical |
| EDGE peak EVM | 1.00%, typical |

²¹ Conditions: Port<n> loopback to Port<n>; BPSK; 906 MHz to 924 MHz; generator power levels -35 dBm to +5 dBm; analyzer maximum power 3 dB above generator power level; EVM averaged over 10 packets; power averaged over 10 packets.

²² Conditions: Port<n> loopback to Port<n>; OQPSK; 2,405 MHz to 2,480 MHz; generator power levels -35 dBm to +5 dBm; analyzer maximum power 3 dB above generator power level; EVM averaged over 10 packets; power averaged over 10 packets.

²³ Conditions: Port<n> loopback to Port<n>; R1, R2, and R3; 865.2 MHz to 926.3 MHz; generator power levels -35 dBm to +5 dBm; analyzer maximum power 1 dB above generator power level; frequency deviation error averaged over 10 packets; power averaged over 10 packets.

²⁴ Conditions: Port<n> loopback to Port<n>; 380 MHz to 1.9 GHz; generator power levels -25 dBm to 0 dBm; analyzer maximum power 2 dB above generator power level.

²⁵ Conditions: Port<n> loopback to Port<n>; 380 MHz to 1.9 GHz; generator power levels -30dBm to -10 dBm; analyzer maximum power 5 dB above generator power level.

Table 25. GSM Output RF Spectrum (GMSK)

| Frequency | Residual Relative Power, Due to Modulation (dB) | Residual Relative Power, Due to Switching (dB) |
|-----------|---|--|
| 600 kHz | -76, typical | -71, typical |
| 1.2 MHz | -76, typical | -72, typical |
| 1.8 MHz | -71, typical | -72, typical |

Conditions: Port<n> loopback to Port<n>; 380 MHz to 1.9 GHz; generator power levels -20 dBm to 0 dBm; analyzer maximum power 2 dB above generator power level.

Table 26. GSM Output RF Spectrum (8-PSK)

| Frequency | Residual Relative Power, Due to Modulation (dB) | Residual Relative Power, Due to Switching (dB) |
|-----------|---|--|
| 600 kHz | -74, typical | -70, typical |
| 1.2 MHz | -74, typical | -70, typical |
| 1.8 MHz | -68, typical | -70, typical |

Conditions: Port<n> loopback to Port<n>; 380 MHz to 1.9 GHz; generator power levels -20 dBm to 0 dBm; analyzer maximum power 5 dB above generator power level.

WCDMA²⁶

| | |
|-------------------------|-----------------|
| BPSK RMS EVM | 0.70%, typical |
| BPSK maximum EVM | 3.00%, typical |
| BPSK ACLR, 5 MHz offset | 60 dB, typical |
| BPSK SEM worst margin | -18 dB, typical |

²⁶ Conditions: Port<n> loopback to Port<n>; 710 MHz to 3.8 GHz; generator power level -15 dBm; analyzer maximum power 6 dB above generator power level.

Figure 32. WCDMA Measured Spectrum²⁷ (ACP)

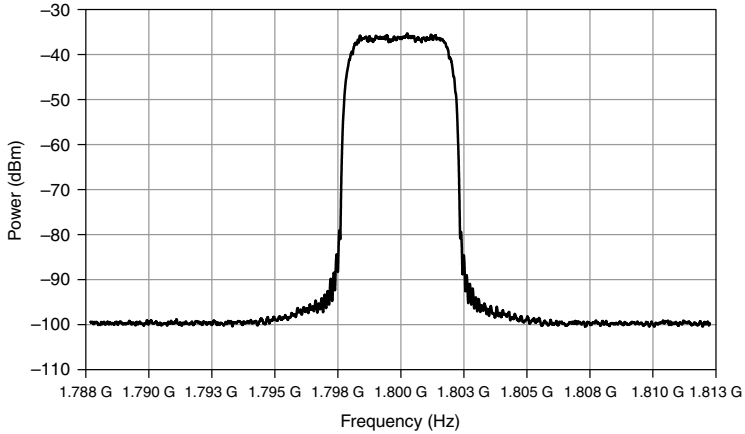

CDMA2K²⁸

Average EVM RMS, RC1

1.1%, typical

Table 27. Adjacent Channel Power (ACP)

| Frequency Offset (MHz) | ACP (dBc) |
|------------------------|-------------|
| 0.885 | 60, typical |
| 1.98 | 61, typical |

LTE²⁹

Average composite EVM

0.8%, typical

²⁷ Conditions: Port<n> loopback to Port<n>; BPSK; 30 averages; generator power level -16 dBm; analyzer maximum power level -10 dBm.

²⁸ Conditions: Port<n> loopback to Port<n>; 710 MHz to 3.8 GHz; generator power levels -28 dBm to -5 dBm; analyzer maximum power 7 dB above generator power level.

²⁹ Conditions: Port<n> loopback to Port<n>; 710 MHz to 3.8 GHz; generator power levels -28 dBm to -5 dBm; analyzer maximum power 9 dB above generator power level for TDD; analyzer maximum power 10 dB above generator power level for FDD.

Table 28. Adjacent Channel Power (ACP), FDD

| Frequency Offset (MHz) | ACP (dBc) |
|------------------------|----------------|
| 7.5 | -48.5, typical |
| 10 | -47, typical |
| 12.5 | -50, typical |

Table 29. Adjacent Channel Power (ACP), TDD

| Frequency Offset (MHz) | ACP (dBc) |
|------------------------|--------------|
| 5.8 | -51, typical |
| 7.4 | -52, typical |
| 10 | -46, typical |

TD-SCDMA

Average EVM RMS³⁰ 0.9%, typical

Spectral emission mask worst margin³¹ -16 dB, typical

Table 30. Adjacent Channel Power (ACP), TDD

| Frequency Offset (MHz) | ACP (dBc) |
|------------------------|-------------|
| 1.6 | 53, typical |
| 3.2 | 64, typical |
| 4.8 | 64, typical |
| 6.4 | 64, typical |
| 8 | 64, typical |

Conditions: Port<n> loopback to Port<n>; 710 MHz to 3.8 GHz; generator power levels -18 dBm to -5 dBm; analyzer maximum power 5 dB above generator power level.

³⁰ Conditions: Port<n> loopback to Port<n>; 710 MHz to 3.8 GHz; generator power levels -28 dBm to -5 dBm; analyzer maximum power 5 dB above generator power level.

³¹ Conditions: Port<n> loopback to Port<n>; 710 MHz to 3.8 GHz; generator power levels -22 dBm to -5 dBm; analyzer maximum power 5 dB above generator power level.

Baseband Characteristics

A/D converters (ADC)

| | |
|-----------------------------|--------------------|
| Resolution | 14 bits |
| Sample rate ³² | 250 MS/s |
| I/Q data rate ³³ | 4 kS/s to 250 MS/s |

D/A converters (DAC)

| | |
|-----------------------------|--------------------|
| Resolution | 16 bits |
| Sample rate ³⁴ | 250 MS/s |
| I/Q data rate ³⁵ | 4 kS/s to 250 MS/s |

Onboard DRAM

| | |
|-------------|----------------------|
| Memory size | 2 banks, 256 MB/bank |
|-------------|----------------------|

Hardware Front Panel

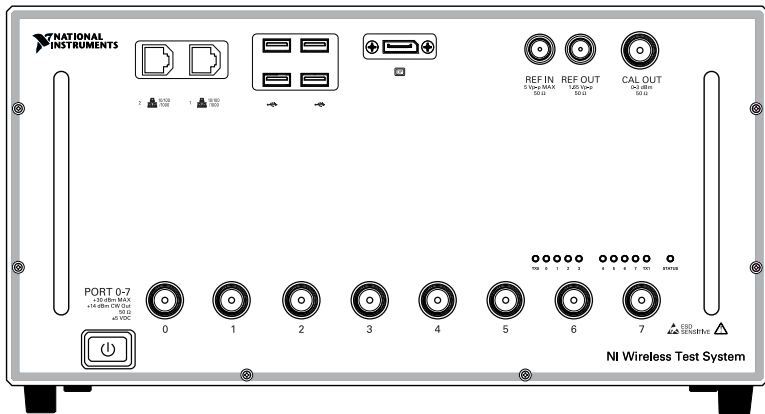

Note The previous illustration is not representative of all WTS options. The front panel of your WTS may differ.



³² ADCs are dual-channel components with each channel assigned to I and Q, respectively.

³³ I/Q data rates lower than 250 MS/s are achieved using fractional decimation.

³⁴ DACs are dual-channel components with each channel assigned to I and Q, respectively. DAC sample rate is internally interpolated to 1 GS/s, automatically configured.

³⁵ I/Q data rates lower than 250 MS/s are achieved using fractional interpolation.

Table 31. WTS Front Panel Icon Definitions

| | |
|---|--|
|  | Refer to the user documentation for required maintenance measures to ensure user safety and/or preserve the specified EMC performance. |
|  | The signal pins of this product's input/output ports can be damaged if subjected to ESD. To prevent damage, turn off power to the product before connecting cables and employ industry-standard ESD prevention measures during installation, maintenance, and operation. |

Front Panel Connectors

Port (0..<n>)

| | |
|----------------------------------|-----------------------------------|
| Connectors | N (female) |
| Input impedance | 50 Ω , nominal, AC coupled |
| Signal analyzer operation | |
| Input amplitude | +30 dBm, maximum |
| Absolute maximum input power | +30 dBm, CW RMS |
| Maximum safe DC input voltage | ± 5 VDC, nominal |
| Signal generator operation | |
| Output impedance | 50 Ω , nominal, AC coupled |
| Output amplitude | +18 dBm, maximum |
| Absolute maximum reverse power | +30 dBm, CW RMS |
| Maximum reverse DC voltage level | ± 5 V, nominal |

Signal Analyzer Operation

Signal Analyzer Return Loss (Voltage Standing Wave Ratio (VSWR))

Table 32. Signal Analyzer Return Loss (dB) (VSWR)

| Frequency | VSWR |
|--|------------------------|
| 109 MHz $\leq f < 2.4$ GHz | 15.5 (1.40:1), typical |
| 2.4 GHz $\leq f < 4$ GHz | 12.7 (1.60:1), typical |
| 4 GHz $\leq f < 6$ GHz | 12.0 (1.67:1) |
| Return loss for frequencies <109 MHz is typically better than 14 dB (VSWR <1.5:1). | |

Figure 33. Signal Analyzer Channel Return Loss³⁶, Typical

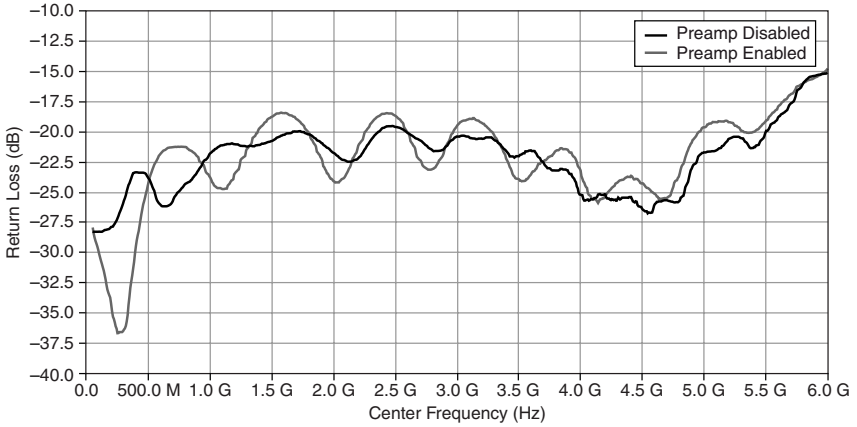

Isolation³⁷

Figure 34. Signal Analyzer Channel-to-Channel and Bank-to-Bank Isolation³⁸, Typical

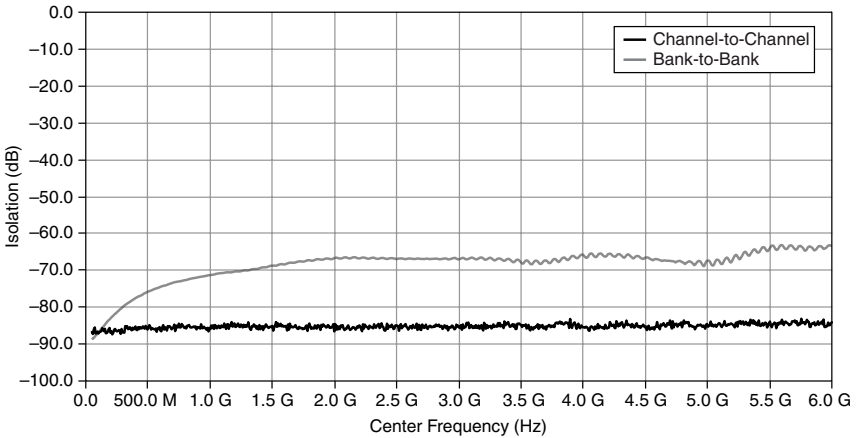

³⁶ Signal generator path not generating and in default state.

³⁷ Measured with an aggressor at one analyzer channel and the system configured to acquire from another analyzer channel or bank. The isolation measurement results are limited by the instrumentation used for testing.

³⁸ The aggressor signal analyzer port is not terminated.

Figure 35. Terminated Signal Analyzer Channel-to-Channel Isolation³⁹, Typical

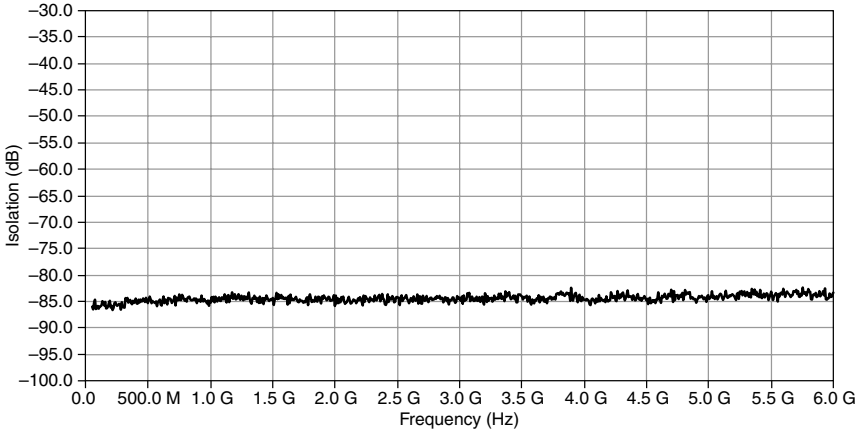

Signal Generator Operation

Signal Generator Return Loss (VSWR)

Table 33. Signal Generator Return Loss (dB) (VSWR)

| Frequency | VSWR |
|--|------------------------|
| 109 MHz $\leq f <$ 2 GHz | 19.0 (1.25:1), typical |
| 2 GHz $\leq f <$ 5 GHz | 14.0 (1.50:1), typical |
| 5 GHz $\leq f <$ 6 GHz | 11.0 (1.78:1) |
| Return loss for frequencies < 109 MHz is typically better than 20 dB (VSWR $< 1.22:1$). | |

³⁹ The aggressor signal analyzer port is internally terminated to 50 Ω .

Figure 36. Signal Generator Channel Return Loss⁴⁰, Typical

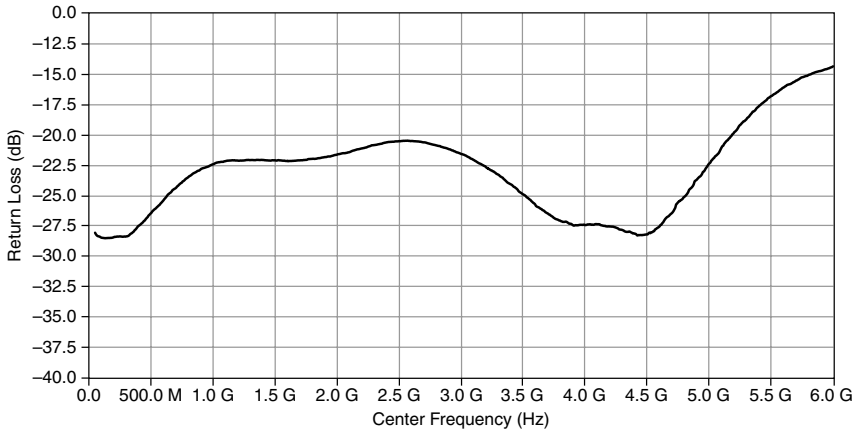

Isolation

Figure 37. Signal Generator Bank-to-Bank Isolation⁴¹, Typical

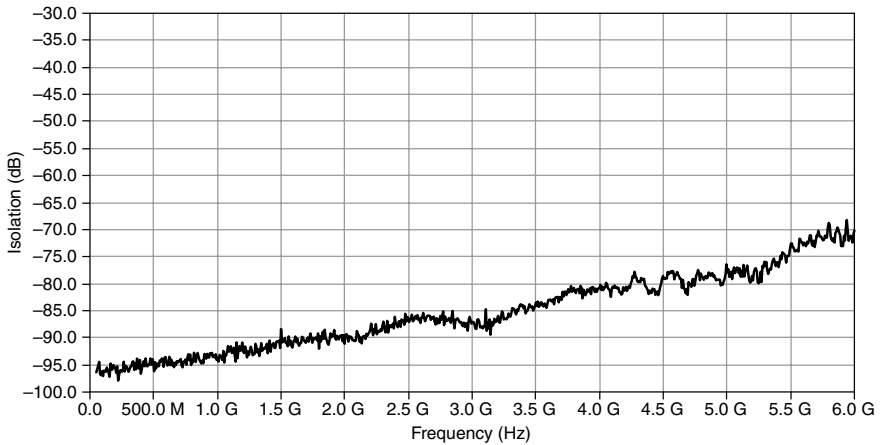

⁴⁰ Signal generator path not generating and in default state.

⁴¹ Isolation between bank A (ports <0..3>) and bank B (ports <4..7>).

REF IN



Note This connector is not supported on all models.

| | |
|-------------------------|---|
| Connector | BNC |
| Frequency | 10 MHz |
| Tolerance ⁴² | $\pm 10 \times 10^{-6}$ |
| Amplitude | |
| Square | 0.7 V _{pk-pk} to 5.0 V _{pk-pk} into 50 Ω, typical |
| Sine ⁴³ | 1.4 V _{pk-pk} to 5.0 V _{pk-pk} into 50 Ω, typical |
| Input impedance | 50 Ω, nominal, AC coupled |
| Maximum input power | +30 dBm |

REF OUT

| | |
|-------------------------------|--|
| Connector | BNC |
| Reference Clock ⁴⁴ | 10 MHz, nominal |
| Amplitude | 1.65 V _{pk-pk} into 50 Ω, nominal |
| Output impedance | 50 Ω, nominal, AC coupled |
| Maximum reverse power | +30 dBm |

CAL OUT

| | |
|-------------------------------|----------------------------|
| Connector | N type (female) |
| Frequency range ⁴⁵ | 65 MHz to 6 GHz |
| Power output | |
| 65 MHz to 3 GHz | 3 dBm, nominal |
| >3 GHz to 6 GHz | 0 dBm, nominal |
| Power | |
| 65 MHz to 3.6 GHz | 0 dBm, ± 2 dB, typical |
| >3.6 GHz to 6 GHz | 3 dBm, ± 2 dB, typical |

⁴² $Frequency\ accuracy = tolerance \times reference\ frequency.$

⁴³ 1 V_{rms} to 3.5 V_{rms}, typical. Jitter performance improves with increased slew rate of input signal.

⁴⁴ Refer to the [Internal Frequency Reference](#) section for accuracy information.

⁴⁵ When tuning in the range of 65 MHz to 375 MHz using the REF IN channel, the exported LO is twice the RF frequency requested.

| | |
|------------------------------------|--|
| Output impedance | 50 Ω , nominal, AC coupled |
| Output return loss | >11.0 dB (VSWR <1.8:1), typical, referenced to 50 Ω |
| Output isolation (state: disabled) | |
| <2.5 GHz frequency | -45 dBc, nominal |
| \geq 2.5 GHz frequency | -35 dBc, nominal |

Ethernet/LAN Interface

| | |
|----------------|----------|
| Connectors (2) | Ethernet |
|----------------|----------|

USB

| | |
|----------------|---------|
| Connectors (4) | USB 2.0 |
|----------------|---------|

Monitor Output

| | |
|------------|-------------|
| Connectors | DisplayPort |
|------------|-------------|

Power Requirements

AC Input

| | |
|---------------------------|--|
| Input voltage range | 100 VAC to 240 VAC |
| Input frequency | 50/60 Hz |
| Operating frequency range | 47 Hz to 63 Hz |
| Input current range | 7.3 A to 3.5 A |
| Line regulation | |
| 3.3 V | < \pm 0.2% |
| 5 V | < \pm 0.1% |
| \pm 12 V | < \pm 0.1% |
| Efficiency | 70%, typical |
| Power disconnect | The AC power cable provides main power disconnect. |

Calibration

| | |
|----------|---------|
| Interval | 2 years |
|----------|---------|

Two Year Calibration Interval Correction Factors

Table 34. Two Year Calibration Interval Correction Factors

| Center Frequency | Two Year Correction (\pm dB) | | |
|----------------------------|---|--|--|
| | Signal Analyzer Absolute Amplitude Accuracy | Signal Generator Absolute Amplitude Accuracy | Third Order Output Intermodulation Distortion (IMD3) |
| 65 MHz to <109 MHz | 0.11 | 0.20 | 0.60 |
| \geq 109 MHz to <600 MHz | 0.11 | 0.20 | 0.60 |
| \geq 600 MHz to <1 GHz | 0.11 | 0.20 | 0.60 |
| \geq 1 GHz to <1.6 GHz | 0.11 | 0.20 | 0.60 |
| \geq 1.6 GHz to <2.7 GHz | 0.11 | 0.20 | 0.60 |
| \geq 2.7 GHz to <3 GHz | 0.11 | 0.20 | 0.60 |
| \geq 3 GHz to <3.6 GHz | 0.11 | 0.20 | 0.60 |
| \geq 3.6 GHz to <4 GHz | 0.11 | 0.30 | 0.90 |
| \geq 4 GHz to <5 GHz | 0.16 | 0.30 | 0.90 |
| \geq 5 GHz to <6 GHz | 0.16 | 0.40 | 1.20 |

Self-Calibration

Self-calibration adjusts the WTS for variations in the environment using an onboard high-precision calibration tone. Perform a complete self-calibration after first setting up your WTS and letting it warm up for 30 minutes.



Note Warm up begins when the PXI Express has been powered on and the operating system has completely loaded.

The WTS is calibrated at the factory; however, you should perform a self-calibration in any of the following situations:

- After first setting up the WTS.
- When the system is in an environment where the ambient temperature varies or the WTS temperature has drifted more than ± 2 °C from the temperature at the last self-calibration.
- To periodically adjust for small performance drifts that occur with product aging.

NI recommends you perform a full instrument self-calibration by executing the `CALibration:RF:FULL` command either through the WTS Software UI or sending it as a SCPI command.



Note Self-calibration may take up to 10 minutes to complete.

Physical Characteristics

| | |
|--------------------------------|---|
| Dimensions (including handles) | 43.51 cm × 35.81 cm × 19.43 cm (17.13 in. × 14.1 in. × 7.65 in.) |
|--------------------------------|---|

Weight

| | |
|--------|---------------------|
| WTS-01 | 16.78 kg (37 lb) |
| WTS-02 | 18.14 kg (40 lb) |
| WTS-03 | 18.31 kg (40.38 lb) |
| WTS-04 | 17.42 kg (38.40 lb) |
| WTS-05 | 20.32 kg (44.80 lb) |

Environment

| | |
|------------------|---|
| Maximum altitude | 2,000 m (800 mbar) (at 25 °C ambient temperature) |
|------------------|---|

| | |
|----------------------|---|
| Measurement category | 2 |
|----------------------|---|

| | |
|------------------|---|
| Pollution Degree | 2 |
|------------------|---|

Indoor use only.

Operating Environment

| | |
|---------------------------|--|
| Ambient temperature range | 0 °C to 50 °C (Tested in accordance with IEC 60068-2-1 and IEC 60068-2-2. Meets MIL-PRF-28800F Class 3 low temperature limit and MIL-PRF-28800F Class 2 high temperature limit.) |
|---------------------------|--|

| | |
|-------------------------|---|
| Relative humidity range | 10% to 90%, noncondensing (Tested in accordance with IEC 60068-2-56.) |
|-------------------------|---|

Storage Environment

| | |
|---------------------------|---|
| Ambient temperature range | -40 °C to 71 °C (Tested in accordance with IEC 60068-2-1 and IEC 60068-2-2. Meets MIL-PRF-28800F Class 3 limits.) |
| Relative humidity range | 10% to 90%, noncondensing (Tested in accordance with IEC 60068-2-56.) |

Shock and Vibration

| | |
|------------------|--|
| Operating shock | 30 g peak, half-sine, 11 ms pulse (Tested in accordance with IEC 60068-2-27. Meets MIL-PRF-28800F Class 2 limits.) |
| Random vibration | |
| Operating | 5 Hz to 500 Hz, 0.3 g _{rms} (Tested in accordance with IEC 60068-2-64.) |
| Nonoperating | 5 Hz to 500 Hz, 2.4 g _{rms} (Tested in accordance with IEC 60068-2-64. Test profile exceeds the requirements of MIL-PRF-28800F, Class 3.) |

Compliance and Certifications

Safety

This product is designed to meet the requirements of the following electrical equipment safety standards for measurement, control, and laboratory use:

- IEC 61010-1, EN 61010-1
- UL 61010-1, CSA C22.2 No. 61010-1



Note For UL and other safety certifications, refer to the product label or the [Online Product Certification](#) section.

Electromagnetic Compatibility

This product meets the requirements of the following EMC standards for electrical equipment for measurement, control, and laboratory use:

- EN 61326-1 (IEC 61326-1): Class A emissions; Basic immunity
- EN 55011 (CISPR 11): Group 1, Class A emissions
- EN 55022 (CISPR 22): Class A emissions
- EN 55024 (CISPR 24): Immunity
- AS/NZS CISPR 11: Group 1, Class A emissions

- AS/NZS CISPR 22: Class A emissions
- FCC 47 CFR Part 15B: Class A emissions
- ICES-001: Class A emissions



Note In the United States (per FCC 47 CFR), Class A equipment is intended for use in commercial, light-industrial, and heavy-industrial locations. In Europe, Canada, Australia, and New Zealand (per CISPR 11), Class A equipment is intended for use only in heavy-industrial locations.



Note Group 1 equipment (per CISPR 11) is any industrial, scientific, or medical equipment that does not intentionally generate radio frequency energy for the treatment of material or inspection/analysis purposes.



Note For EMC declarations, certifications, and additional information, refer to the [Online Product Certification](#) section.

CE Compliance

This product meets the essential requirements of applicable European Directives, as follows:

- 2014/35/EU; Low-Voltage Directive (safety)
- 2014/30/EU; Electromagnetic Compatibility Directive (EMC)

Online Product Certification

Refer to the product Declaration of Conformity (DoC) for additional regulatory compliance information. To obtain product certifications and the DoC for this product, visit ni.com/certification, search by model number or product line, and click the appropriate link in the Certification column.

Environmental Management

NI is committed to designing and manufacturing products in an environmentally responsible manner. NI recognizes that eliminating certain hazardous substances from our products is beneficial to the environment and to NI customers.

For additional environmental information, refer to the *Minimize Our Environmental Impact* web page at ni.com/environment. This page contains the environmental regulations and directives with which NI complies, as well as other environmental information not included in this document.

Waste Electrical and Electronic Equipment (WEEE)



EU Customers At the end of the product life cycle, all NI products must be disposed of according to local laws and regulations. For more information about how to recycle NI products in your region, visit ni.com/environment/weee.

电子信息产品污染控制管理办法（中国 RoHS）



中国客户 National Instruments 符合中国电子信息产品中限制使用某些有害物质指令 (RoHS)。关于 National Instruments 中国 RoHS 合规性信息，请登录 ni.com/environment/rohs_china。(For information about China RoHS compliance, go to ni.com/environment/rohs_china.)

Worldwide Support and Services

The National Instruments website is your complete resource for technical support. At ni.com/support, you have access to everything from troubleshooting and application development self-help resources to email and phone assistance.

Visit ni.com/services for information about repairs, extended warranty, calibration, and other services.

Visit ni.com/register to register your NI product. Product registration facilitates technical support and ensures that you receive important information updates from NI.

A Declaration of Conformity (DoC) is our claim of compliance with the Council of the European Communities using the manufacturer's declaration of conformity. This system affords the user protection for electromagnetic compatibility (EMC) and product safety. You can obtain the DoC for your product by visiting ni.com/certification. If your product supports calibration, you can obtain the calibration certificate for your product at ni.com/calibration.

NI corporate headquarters is located at 11500 North Mopac Expressway, Austin, Texas, 78759-3504. NI also has offices located around the world. For telephone support in the United States, create your service request at ni.com/support or dial 1 866 ASK MYNI (275 6964). For telephone support outside the United States, visit the *Worldwide Offices* section of ni.com/niglobal to access the branch office websites, which provide up-to-date contact information, support phone numbers, email addresses, and current events.

Information is subject to change without notice. Refer to the *NI Trademarks and Logo Guidelines* at ni.com/trademarks for information on NI trademarks. Other product and company names mentioned herein are trademarks or trade names of their respective companies. For patents covering NI products/technology, refer to the appropriate location: **Help»Patents** in your software, the `patents.txt` file on your media, or the *National Instruments Patent Notice* at ni.com/patents. You can find information about end-user license agreements (EULAs) and third-party legal notices in the `readme` file for your NI product. Refer to the *Export Compliance Information* at ni.com/legal/export-compliance for the NI global trade compliance policy and how to obtain relevant HTS codes, ECCNs, and other import/export data. NI MAKES NO EXPRESS OR IMPLIED WARRANTIES AS TO THE ACCURACY OF THE INFORMATION CONTAINED HEREIN AND SHALL NOT BE LIABLE FOR ANY ERRORS. U.S. Government Customers: The data contained in this manual was developed at private expense and is subject to the applicable limited rights and restricted data rights as set forth in FAR 52.227-14, DFAR 252.227-7014, and DFAR 252.227-7015.

© 2015—2017 National Instruments. All rights reserved.

375081C-01 September 15, 2017