

# **Getting Started with Your AT-GPIB/TNT and the NI-488.2™ Software for DOS**

**June 1997 Edition**

**Part Number 320718C-01**

**© Copyright 1993, 1997 National Instruments Corporation.  
All Rights Reserved.**

**Internet Support**

support@natinst.com

E-mail: info@natinst.com

FTP Site: ftp.natinst.com

Web Address: <http://www.natinst.com>

**Bulletin Board Support**

BBS United States: (512) 794-5422

BBS United Kingdom: 01635 551422

BBS France: 01 48 65 15 59

**Fax-on-Demand Support**

(512) 418-1111

**Telephone Support (U.S.)**

Tel: (512) 795-8248

Fax: (512) 794-5678

**International Offices**

Australia 03 9879 5166, Austria 0662 45 79 90 0, Belgium 02 757 00 20,  
Canada (Ontario) 905 785 0085, Canada (Québec) 514 694 8521,  
Denmark 45 76 26 00, Finland 09 725 725 11, France 01 48 14 24 24,  
Germany 089 741 31 30, Hong Kong 2645 3186, Israel 03 5734815,  
Italy 02 413091, Japan 03 5472 2970, Korea 02 596 7456, Mexico 5 520 2635,  
Netherlands 0348 433466, Norway 32 84 84 00, Singapore 2265886,  
Spain 91 640 0085, Sweden 08 730 49 70, Switzerland 056 200 51 51,  
Taiwan 02 377 1200, U.K. 01635 523545

**National Instruments Corporate Headquarters**

6504 Bridge Point Parkway Austin, TX 78730-5039 Tel: (512) 794-0100

## **Limited Warranty**

The AT-GPIB/TNT and AT-GPIB hardware are warranted against defects in materials and workmanship for a period of two years from the date of shipment, as evidenced by receipts or other documentation. National Instruments will, at its option, repair or replace equipment that proves to be defective during the warranty period. This warranty includes parts and labor.

The media on which you receive National Instruments software are warranted not to fail to execute programming instructions, due to defects in materials and workmanship, for a period of 90 days from date of shipment, as evidenced by receipts or other documentation. National Instruments will, at its option, repair or replace software media that do not execute programming instructions if National Instruments receives notice of such defects during the warranty period. National Instruments does not warrant that the operation of the software shall be uninterrupted or error free.

A Return Material Authorization (RMA) number must be obtained from the factory and clearly marked on the outside of the package before any equipment will be accepted for warranty work. National Instruments will pay the shipping costs of returning to the owner parts which are covered by warranty.

National Instruments believes that the information in this manual is accurate. The document has been carefully reviewed for technical accuracy. In the event that technical or typographical errors exist, National Instruments reserves the right to make changes to subsequent editions of this document without prior notice to holders of this edition. The reader should consult National Instruments if errors are suspected. In no event shall National Instruments be liable for any damages arising out of or related to this document or the information contained in it.

EXCEPT AS SPECIFIED HEREIN, NATIONAL INSTRUMENTS MAKES NO WARRANTIES, EXPRESS OR IMPLIED, AND SPECIFICALLY DISCLAIMS ANY WARRANTY OF MERCHANTABILITY OR FITNESS FOR A PARTICULAR PURPOSE. CUSTOMER'S RIGHT TO RECOVER DAMAGES CAUSED BY FAULT OR NEGLIGENCE ON THE PART OF NATIONAL INSTRUMENTS SHALL BE LIMITED TO THE AMOUNT THEREFORE PAID BY THE CUSTOMER. NATIONAL INSTRUMENTS WILL NOT BE LIABLE FOR DAMAGES RESULTING FROM LOSS OF DATA, PROFITS, USE OF PRODUCTS, OR INCIDENTAL OR CONSEQUENTIAL DAMAGES, EVEN IF ADVISED OF THE POSSIBILITY THEREOF. This limitation of the liability of National Instruments will apply regardless of the form of action, whether in contract or tort, including negligence. Any action against National Instruments must be brought within one year after the cause of action accrues. National Instruments shall not be liable for any delay in performance due to causes beyond its reasonable control. The warranty provided herein does not cover damages, defects, malfunctions, or service failures caused by owner's failure to follow the National Instruments installation, operation, or maintenance instructions; owner's modification of the product; owner's abuse, misuse, or negligent acts; and power failure or surges, fire, flood, accident, actions of third parties, or other events outside reasonable control.

## **Copyright**

Under the copyright laws, this publication may not be reproduced or transmitted in any form, electronic or mechanical, including photocopying, recording, storing in an information retrieval system, or translating, in whole or in part, without the prior written consent of National Instruments Corporation.

## **Trademarks**

NAT4882<sup>®</sup>, NI-488<sup>®</sup>, Turbo488<sup>®</sup>, NI-488.2<sup>™</sup>, and TNT4882C<sup>™</sup> are trademarks of National Instruments Corporation.

Product and company names listed are trademarks or trade names of their respective companies.

## **WARNING REGARDING MEDICAL AND CLINICAL USE OF NATIONAL INSTRUMENTS PRODUCTS**

National Instruments products are not designed with components and testing intended to ensure a level of reliability suitable for use in treatment and diagnosis of humans. Applications of National Instruments products involving medical or clinical treatment can create a potential for accidental injury caused by product failure, or by errors on the part of the user or application designer. Any use or application of National Instruments products for or involving medical or clinical treatment must be performed by properly trained and qualified medical personnel, and all traditional medical safeguards, equipment, and procedures that are appropriate in the particular situation to prevent serious injury or death should always continue to be used when National Instruments products are being used. National Instruments products are NOT intended to be a substitute for any form of established process, procedure, or equipment used to monitor or safeguard human health and safety in medical or clinical treatment.

# **FCC/DOC Radio Frequency Interference Compliance**

This equipment generates and uses radio frequency energy and, if not installed and used in strict accordance with the instructions in this manual, may cause interference to radio and television reception. This equipment has been tested and found to comply with the following two regulatory agencies:

## **Federal Communications Commission**

This device complies with Part 15 of the Federal Communications Commission (FCC) Rules for a Class B digital device. A Class B device is distinguishable from a Class A device by the appearance of an FCC ID number located on the Class B device.

## **Canadian Department of Communications**

This device complies with the limits for radio noise emissions from digital apparatus set out in the Radio Interference Regulations of the Canadian Department of Communications (DOC).

Le présent appareil numérique n'émet pas de bruits radioélectriques dépassant les limites applicables aux appareils numériques de classe B prescrites dans le règlement sur le brouillage radioélectrique édicté par le ministère des communications du Canada.

## **Instructions to Users**

These regulations are designed to provide reasonable protection against interference from the equipment to radio and television reception in residential areas.

There is no guarantee that interference will not occur in a particular installation. However, the chances of interference are much less if the equipment is installed and used according to this instruction manual.

If the equipment does cause interference to radio or television reception, which can be determined by turning the equipment on and off, one or more of the following suggestions may reduce or eliminate the problem.

- Operate the equipment and the receiver on different branches of your AC electrical system.
- Move the equipment away from the receiver with which it is interfering.
- Reorient or relocate the receiver's antenna.
- Be sure that the equipment is plugged into a grounded outlet and that the grounding has not been defeated with a cheater plug.

**Notice to user:** Changes or modifications not expressly approved by National Instruments could void the user's authority to operate the equipment under the FCC Rules.

If necessary, consult National Instruments or an experienced radio/television technician for additional suggestions. The following booklet prepared by the FCC may also be helpful: *How to Identify and Resolve Radio-TV Interference Problems*. This booklet is available from the U.S. Government Printing Office, Washington, DC 20402, Stock Number 004-000-00345-4.

### **Bescheinigung des Herstellers/Importeurs**

Hiermit wird bescheinigt, daß die AT-GPIB in Übereinstimmung mit den Bestimmungen der Vfg. 1046/1984 funk entstört ist.

Der Detuschen Bundespost wurde das Inverkehrbringen dieses Gerätes angezeigt und die Berechtigung zur Überprüfung der Serie auf Bestimmungen eingeräumt.

# Contents

---

<b>About This Manual</b> .....	ix
How to Use the Manual Set .....	ix
Organization of This Manual .....	x
Conventions Used in This Manual .....	xi
Related Documentation .....	xii
Customer Communication .....	xii
<b>Chapter 1</b>	
<b>Introduction</b> .....	1-1
How to Use This Manual .....	1-1
What You Need to Get Started .....	1-2
Hardware Description .....	1-2
Software Description .....	1-3
Optional Programming Environments .....	1-3
<b>Chapter 2</b>	
<b>Hardware Configuration and Installation</b> .....	2-1
Note to EISA Users .....	2-1
Install the Hardware .....	2-2
Configure the Hardware (Optional) .....	2-3
Selecting the Base I/O Address .....	2-5
Selecting the Interrupt Request Line .....	2-8
Selecting the DMA Channel .....	2-10
Using Programmed I/O for GPIB Transfers .....	2-11
Setting the Shield Ground Configuration .....	2-12
<b>Chapter 3</b>	
<b>Software Installation and Configuration</b> .....	3-1
NI-488.2 Software Components .....	3-1
Install the Software .....	3-1
Configure the Software with ibconf .....	3-3
<b>Chapter 4</b>	
<b>Installation Verification and Troubleshooting</b> .....	4-1
Run the Hardware Diagnostic Program .....	4-1
Troubleshooting ibdiag Error Messages .....	4-1
Using Single-cycle DMA .....	4-1
Correcting Hardware Settings .....	4-2
Run the Software Diagnostic Program .....	4-3
Troubleshooting ibtest Error Messages .....	4-3
Presence Test of Driver .....	4-3
Presence Test of Board .....	4-4

GPIB Cables Connected .....	4-4
ULI Driver Loaded .....	4-4
Common Questions .....	4-5
<b>Chapter 5</b>	
<b>Using Your NI-488.2 Software</b> .....	5-1
Introduction to ibic.....	5-1
General Programming Considerations.....	5-1
<b>Appendix A</b>	
<b>Hardware Specifications</b> .....	A-1
<b>Appendix B</b>	
<b>Customer Communication</b> .....	B-1
<b>Glossary</b> .....	Glossary-1

## Figures

Figure 2-1.	Installing the GPIB Board.....	2-3
Figure 2-2.	AT-GPIB/TNT Parts Locator Diagram.....	2-4
Figure 2-3.	AT-GPIB Parts Locator Diagram .....	2-5
Figure 2-4.	Base I/O Address Switch Settings .....	2-7
Figure 2-5.	Interrupt Jumper Setting for IRQ11 (Default Setting).....	2-9
Figure 2-6.	Interrupt Jumper Setting for IRQ5 .....	2-9
Figure 2-7.	Jumper Setting for Disabling Interrupts.....	2-9
Figure 2-8.	DMA Channel Jumper Setting for DMA Channel 7.....	2-11
Figure 2-9.	DMA Jumper Setting for No DMA Channel .....	2-11
Figure 2-10.	Ground Configuration Jumper Settings .....	2-12

## Tables

Table 2-1.	Hardware Default Settings .....	2-1
Table 2-2.	Possible Base I/O Address Switch Settings .....	2-6
Table 2-3.	DMA Channels .....	2-10
Table A-1.	Electrical Characteristics for the AT-GPIB/TNT board .....	A-1
Table A-2.	Electrical Characteristics for the AT-GPIB board .....	A-1
Table A-3.	Physical Characteristics .....	A-2
Table A-4.	Environmental Characteristics .....	A-2



# About This Manual

---

This manual contains instructions to help you install and configure the National Instruments AT-GPIB/TNT or AT-GPIB interface board and the NI-488.2 software for DOS. The NI-488.2 software is intended for use with MS-DOS version 3.0 or higher (or equivalent).

This manual uses the term *AT-GPIB/TNT* to refer to a National Instruments GPIB board for the ISA (PC AT) bus equipped with the TNT4882C ASIC. The term *AT-GPIB* refers to a National Instruments GPIB board for the ISA (PC AT) bus equipped with the NAT4882 and Turbo488 ASICs. This manual also uses the term *GPIB board* in cases where the material can apply to either board.

This manual assumes that you are already familiar with DOS.

## How to Use the Manual Set

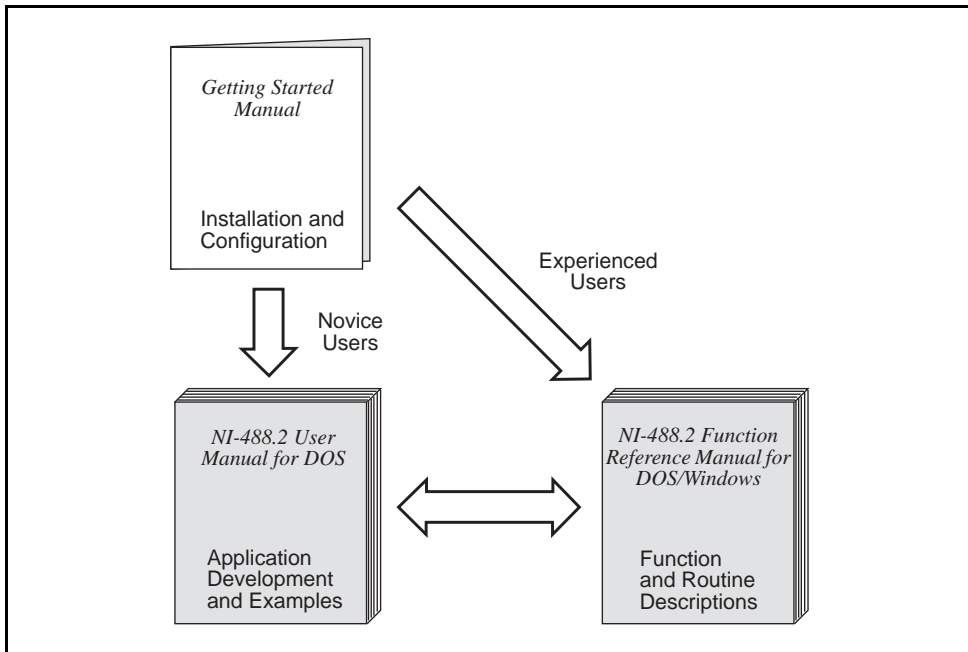

Use this getting started manual to install and configure your GPIB board and the NI-488.2 software for DOS.

Use the *NI-488.2 User Manual for DOS* to learn the basics of GPIB and how to develop an application program. The user manual also contains debugging information and detailed examples.

Use the *NI-488.2 Function Reference Manual for DOS/Windows* for specific NI-488 function and NI-488.2 routine information, such as format, parameters, and possible errors.

## **Organization of This Manual**

This manual is organized as follows:

- Chapter 1, *Introduction*, explains how to use this manual, lists what you need to get started, and briefly describes the GPIB board and the NI-488.2 software.
- Chapter 2, *Hardware Configuration and Installation*, contains instructions to help you configure and install your GPIB board.
- Chapter 3, *Software Installation and Configuration*, contains instructions to help you install and configure your NI-488.2 software.
- Chapter 4, *Installation Verification and Troubleshooting*, describes how to verify the hardware and software installation and how to troubleshoot problems.
- Chapter 5, *Using Your NI-488.2 Software*, describes the `ibic` utility and lists some programming considerations.
- Appendix A, *Hardware Specifications*, describes the physical characteristics of the GPIB board and the recommended operating conditions.
- Appendix B, *Customer Communication*, contains forms you can use to request help from National Instruments or to comment on our products and manuals.
- The *Glossary* contains an alphabetical list and a description of terms used in this manual, including abbreviations, acronyms, metric prefixes, mnemonics, and symbols.

## Conventions Used in This Manual

The following conventions are used in this manual.

<i>italic</i>	Italic text denotes emphasis, a cross reference, or an introduction to a key concept.
<b><i>bold italic</i></b>	Bold italic text denotes a note, caution, or warning.
monospace	Text in this font denotes text or characters that are to be literally input from the keyboard, sections of code, programming examples, and syntax examples. This font is also used for the proper names of disk drives, directories, programs, subprograms, subroutines, device names, functions, variables, field names and filenames.
<b>bold monospace</b>	Bold text in this font denotes the messages and responses that the computer automatically prints to the screen.
<>	Angle brackets enclose the name of a key on the keyboard—for example, <PageDown>.
-	A hyphen between two or more key names enclosed in angle brackets denotes that you should simultaneously press the named keys—for example, <Control-Alt-Delete>.
<Enter>	Key names are capitalized.
AT-GPIB/TNT	AT-GPIB/TNT refers to a National Instruments GPIB board for the ISA (PC AT) bus equipped with the TNT4882C ASIC.
AT-GPIB	AT-GPIB refers to a National Instruments GPIB board for the ISA (PC AT) bus equipped with the NAT4882 and Turbo488 ASICs.
GPIB board	GPIB board refers generically to either the AT-GPIB/TNT or the AT-GPIB board in cases where the material can apply to either board.
IEEE 488 and IEEE 488.2	IEEE 488 and IEEE 488.2 refer to the ANSI/IEEE Standard 488.1-1987 and the ANSI/IEEE Standard 488.2-1987, respectively, which define the GPIB.

Abbreviations, acronyms, metric prefixes, mnemonics, symbols, and terms are listed in the *Glossary*.

## **Related Documentation**

The following documents contain information that you may find helpful as you read this manual.

- ANSI/IEEE Standard 488.1-1987, *IEEE Standard Digital Interface for Programmable Instrumentation*
- ANSI/IEEE Standard 488.2-1987, *IEEE Standard Codes, Formats, Protocols, and Common Commands*
- *Microsoft MS-DOS User's Guide*, Microsoft Corporation

## **Customer Communication**

National Instruments wants to receive your comments on our products and manuals. We are interested in the applications you develop with our products, and we want to help if you have problems with them. To make it easy for you to contact us, this manual contains comment and configuration forms for you to complete. These forms are in Appendix B, *Customer Communication*, at the end of this manual.

# Chapter 1

## Introduction

---

This chapter explains how to use this manual, lists what you need to get started, and briefly describes the GPIB board and the NI-488.2 software.

### How to Use This Manual

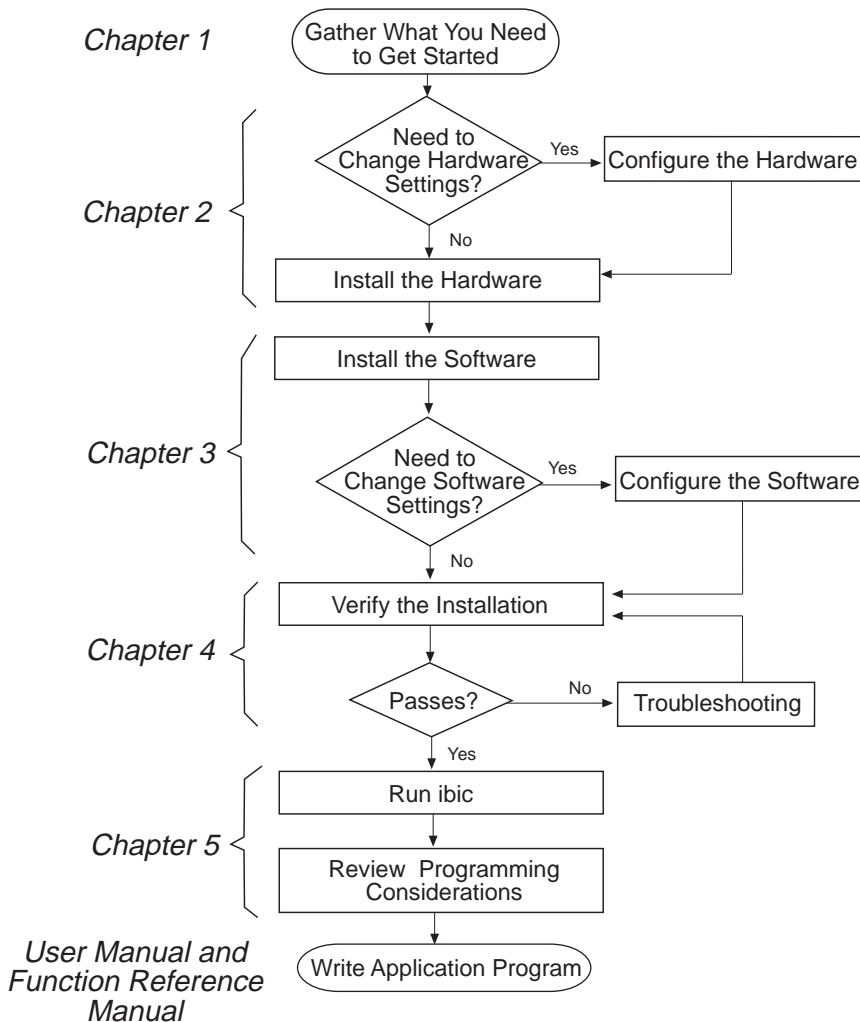

## What You Need to Get Started

- ❑ AT-GPIB/TNT board
- or
- AT-GPIB board
- ❑ 3.5 in. high density (1.44 MB) *NI-488.2 Software for DOS. Distribution Disk for the AT-GPIB/TNT and the AT-GPIB*
- ❑ MS-DOS version 3.0 or higher (or equivalent) installed on your computer

## Hardware Description

The AT-GPIB/TNT board, equipped with a TNT4882C ASIC, transforms any PC AT compatible computer into a full-functioning GPIB Talker/Listener/Controller. The TNT4882C chip combines the circuitry of the NAT4882 ASIC, the Turbo488 performance-enhancing ASIC, and GPIB transceivers to create a single-chip IEEE 488.2 Talker/Listener/Controller interface. The TNT4882C also implements the HS488 high-speed protocol, which increases the maximum data transfer rate of the AT-GPIB/TNT up to 3.4 Mbytes/s, when used in an EISA computer. For more information about HS488, refer to Chapter 7, *GPIB Programming Techniques*, in the *NI-488.2 User Manual for DOS*.

The AT-GPIB board, equipped with NAT4882 and Turbo488 ASICs, also transforms any PC AT compatible computer with 16-bit slots into a full-functioning IEEE 488.2 Talker/Listener/Controller. The NAT4882 controller chip is fully compatible with the IEEE 488.2 standard. The Turbo488 performance-enhancing chip boosts GPIB read and write transfers to rates exceeding 1 Mbytes/s.

The AT-GPIB/TNT board is fully software compatible with all versions of AT-GPIB hardware. You can use standard GPIB cables to connect the AT-GPIB/TNT with up to 14 instruments. You can connect the AT-GPIB board with up to 13 instruments. If you want to use more than the maximum number of instruments, you can order a bus extender or expander from National Instruments. Refer to Appendix A, *Hardware Specifications*, for more information about the GPIB hardware specifications and recommended operating conditions.

## **Software Description**

The NI-488.2 software for DOS includes a loadable DOS device driver, language interface libraries, and debugging and development utilities. The NI-488.2 software and GPIB hardware transform a general-purpose PC into a GPIB Talker/Listener/Controller that has complete communications and bus management capability.

## **Optional Programming Environments**

Your kit includes the NI-488.2 software for DOS. In addition, you can order the LabWindows<sup>®</sup> software from National Instruments. LabWindows include instrument driver libraries that make it easier to communicate with your GPIB instruments.

LabWindows is an interactive C/QuickBASIC development environment for building test and measurement and instrument control systems. It includes interactive code-generation tools and a graphical editor for building custom user interfaces. It also includes built-in libraries for IEEE 488.2, VXI, RS-232 control, and plug-in data acquisition. When you order LabWindows, you also get more than 300 complete instrument drivers, which are modular, source-code programs that handle the communication with your instrument so that you do not have to learn the programming details.

For more information about LabWindows, contact National Instruments.

# Chapter 2

## Hardware Configuration and Installation

---

This chapter contains instructions to help you configure and install your GPIB board.

**Warning:** *Several components on your GPIB board can be damaged by electrostatic discharge. To avoid such damage in handling the board, touch the antistatic plastic package to a metal part of your computer chassis before removing the board from the package.*

The GPIB board default settings are suitable for most PC AT compatible computer systems. However, if the default settings conflict with another device in your system or if you need to install more than one GPIB board, you must reconfigure the hardware. If you already have GPIB boards installed in your computer, you can run the GPIBInfo utility to determine how the boards are configured. For more information about GPIBInfo, refer to Chapter 4, *Debugging Your Application*, in the *NI-488.2 User Manual for DOS*.

Table 2-1 shows the default settings for the switches and jumpers on the GPIB board.

Table 2-1. Hardware Default Settings

GPIB Board Setting	Default
Base I/O Address (hex)	2C0
DMA Channel	5
Interrupt Line (IRQ)	11

To modify the default settings of the GPIB board, refer to the *Configure the Hardware* section of this chapter. If you do not need to reconfigure the board, refer to the *Install the Hardware* section.

### Note to EISA Users

If you have an EISA bus-based computer, you can use the EISA configuration files included on your NI-488.2 distribution disk to configure your GPIB board. EISA configuration files for the AT-GPIB/TNT and AT-GPIB are located on the first distribution disk. Follow the instructions that came with your computer to copy the appropriate EISA configuration file to your EISA configuration disk. Then, run your EISA configuration program, which uses the information in the configuration file to help you select appropriate settings for the GPIB hardware. After the EISA configuration program determines the settings, you must manually set the DIP switches and jumpers on the GPIB hardware to match the selections.



## Install the Hardware

Keep in mind the following naming conventions as you read through the rest of this manual.

- *AT-GPIB/TNT* refers to a National Instruments GPIB board for the ISA (PC AT) bus equipped with the TNT4882C ASIC.
- *AT-GPIB* refers to a National Instruments GPIB board for the ISA (PC AT) bus equipped with the NAT4882 and Turbo488 ASICs.
- *GPIB board* refers generically to either the AT-GPIB/TNT or AT-GPIB board in cases where the material can apply to either board.

Perform the following steps to install the GPIB board:

1. Turn off your computer. Keep the computer plugged in so that it remains grounded while you install the GPIB board.
2. Remove the top cover or access port of the I/O channel.
3. Remove the expansion slot cover on the back panel of the computer.
4. Insert the GPIB board into any unused 16-bit ISA slot with the GPIB connector sticking out of the opening on the back panel, as shown in Figure 2-1. It might be a tight fit, but do not force the board into place. You can install the AT-GPIB/TNT in an 8-bit slot, if necessary. When you use an 8-bit slot, you must disable DMA and use only interrupt request lines 3, 4, 5, 6, 7, or None.

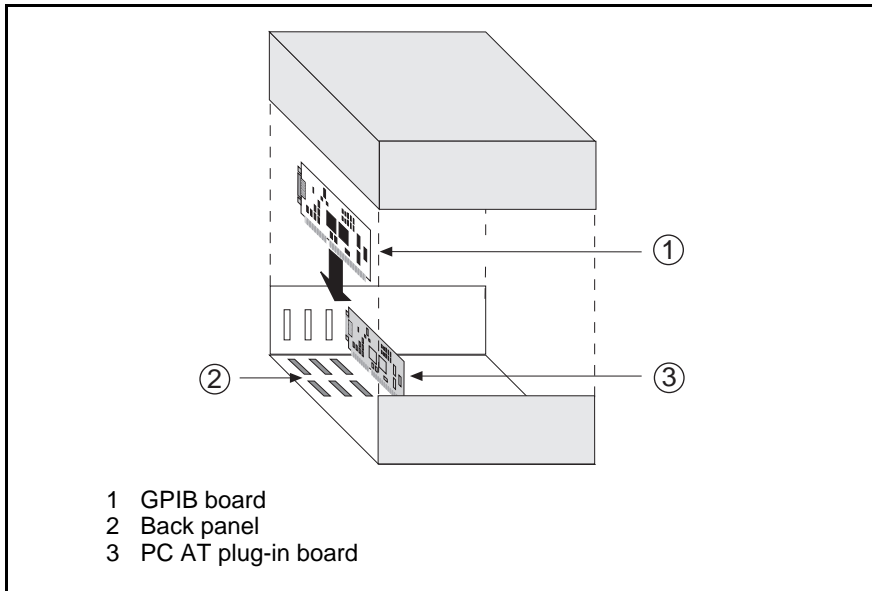

Figure 2-1. Installing the GPIB Board

5. Screw the mounting bracket of the GPIB board to the back panel rail of the computer.
6. Check the installation.
7. Replace the top cover or access port to the I/O channel.
8. Turn on your computer.

After you have installed your board, you are ready to install the NI-488.2 software. Refer to Chapter 3, *Software Installation and Configuration*.

## Configure the Hardware (Optional)

Follow the instructions in this section to change the hardware default settings of the GPIB board. The GPIB board default settings are suitable for most PC AT compatible computer systems. However, if the default settings conflict with another device in your system or if you need to install more than one GPIB board, you must reconfigure the hardware.

The default settings for the switches and jumpers on the GPIB board are:

- Base I/O Address (hex): 2C0
- DMA Channel: 5
- Interrupt Line (IRQ): 11

Figure 2-2 shows the location of the configuration jumpers and switches on the AT-GPIB/TNT board.

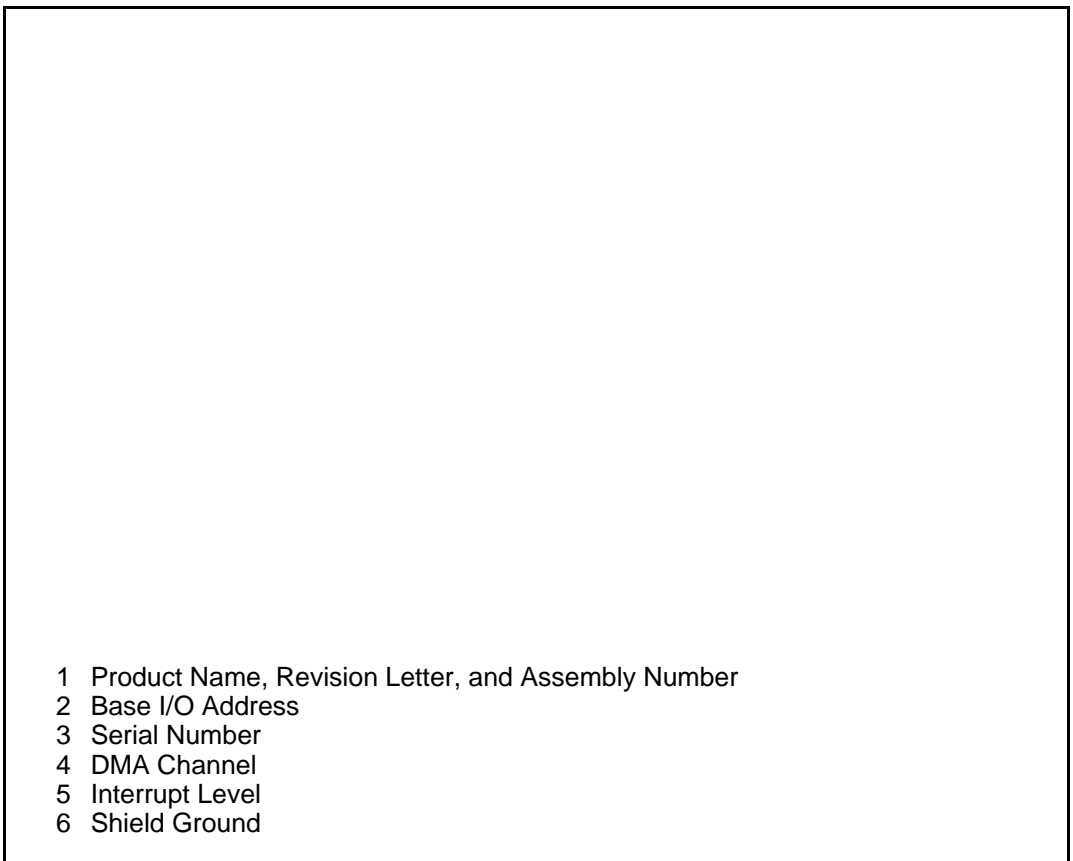

Figure 2-2. AT-GPIB/TNT Parts Locator Diagram

Figure 2-3 shows the location of the configuration jumpers and switches on the AT-GPIB board.

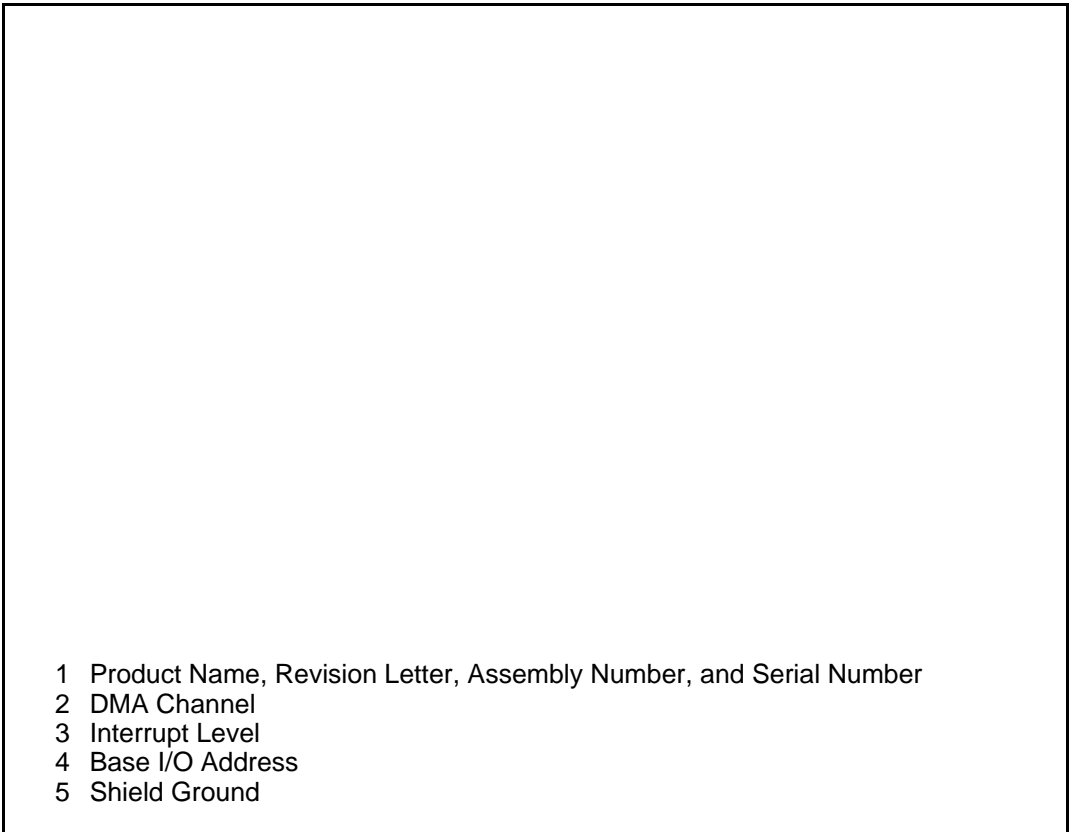

Figure 2-3. AT-GPIB Parts Locator Diagram

## Selecting the Base I/O Address

PC AT compatible computers have a segment of address space reserved for input and output. This segment is referred to as the I/O address space. The base I/O address of a PC AT plug-in board such as the GPIB board is the first position in the I/O address space occupied by the plug-in interface board.

By default, the GPIB board is configured to use base I/O address 2C0 hex. With this setting, the board uses the I/O address space 2C0 hex through 2DF hex. If this address range is already in use by another device or if you are installing more than one board, follow these steps to reconfigure the base I/O address setting.

## 1. Choose a new base I/O address setting.

You can configure the base I/O addresses to any setting between 0x100 and 0x3E0 that is a multiple of 0x20 hex. If you are installing more than one GPIB board, each board must use a unique base I/O address.

Table 2-2 lists the possible switch settings, the corresponding base I/O addresses, and the I/O address space used for each setting.

Table 2-2. Possible Base I/O Address Switch Settings

Switch Setting					Base I/O Address (hex)	I/O Address Space Used (hex)
A9	A8	A7	A6	A5		
0	1	0	0	0	100	100 to 11F
0	1	0	0	1	120	120 to 13F
0	1	0	1	0	140	140 to 15F
0	1	0	1	1	160	160 to 17F
0	1	1	0	0	180	180 to 19F
0	1	1	0	1	1A0	1A0 to 1BF
0	1	1	1	0	1C0	1C0 to 1DF
0	1	1	1	1	1E0	1E0 to 1FF
1	0	0	0	0	200	200 to 21F
1	0	0	0	1	220	220 to 23F
1	0	0	1	0	240	240 to 25F
1	0	0	1	1	260	260 to 27F
1	0	1	0	0	280	280 to 29F
1	0	1	0	1	2A0	2A0 to 2BF
1	0	1	1	0	2C0	2C0 to 2DF
1	0	1	1	1	2E0	2E0 to 2FF
1	1	0	0	0	300	300 to 31F
1	1	0	0	1	320	320 to 33F
1	1	0	1	0	340	340 to 35F
1	1	0	1	1	360	360 to 37F
1	1	1	0	0	380	380 to 39F
1	1	1	0	1	3A0	3A0 to 3BF
1	1	1	1	0	3C0	3C0 to 3DF
1	1	1	1	1	3E0	3E0 to 3FF

2. Locate the base I/O address switch at SW1 on your AT-GPIB/TNT board or at U25 on your AT-GPIB board. Refer to the appropriate parts locator diagram, Figure 2-2 or 2-3.
3. Change the switch settings to configure the GPIB board to the new base I/O address.

Press down on the side marked OFF to select a binary value of 1 for the corresponding address bit. Press down on the ON side of the switch to select a binary value of 0. Refer to Figure 2-4 for an example of the switch settings and corresponding base I/O addresses.

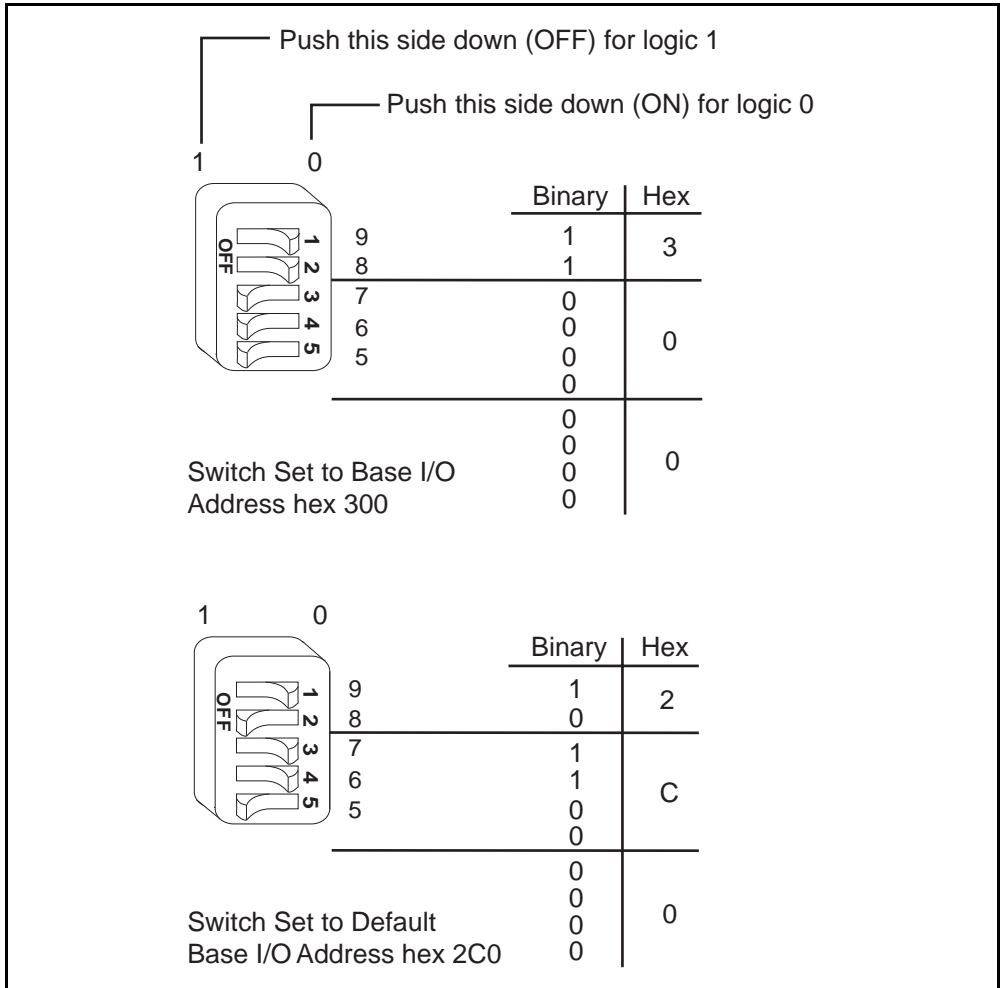

Figure 2-4. Base I/O Address Switch Settings

4. Record your new setting on the *GPIB Board Hardware and Software Configuration Form* in Appendix B, *Customer Communication*.
5. Remember that after you install the NI-488.2 software, you must use the `ibconf` utility to configure your software settings to match your new hardware settings. Refer to the *Configure the Software with ibconf* section in Chapter 3, *Software Installation and Configuration*, for information on `ibconf`.

## Selecting the Interrupt Request Line

PC AT compatible computers have a series of interrupt lines available to devices. Devices use interrupts to get immediate service from the CPU for asynchronous events. Your GPIB hardware and the NI-488.2 software use interrupts to get service from the CPU when necessary.

By default, the GPIB board is configured to use interrupt request line 11. If this is not an acceptable setting or if you are installing more than one board, follow these steps to reconfigure the interrupt request line:

1. Choose a new interrupt request line (IRQ) setting.

When installed in a 16-bit ISA slot, you can configure the GPIB board to use any of the following interrupt lines: IRQ3, 4, 5, 7, 9, 10, 11, 12, 15, or None. Do not use interrupt line 6 or interrupt line 14. Interrupt line 6 is used by the diskette drive controller and interrupt line 14 is used by the hard disk drive controller on most PC ATs.

If you have installed the AT-GPIB/TNT board in an 8-bit (PC-style) slot, the only interrupt lines available to you are 3, 4, 5, 6, 7, or None. The AT-GPIB board can only be installed in a 16-bit slot.

If you are installing more than one GPIB board, each board must either use a unique IRQ level or not use interrupts at all.

2. Find the jumpers that set the interrupt request line. The jumpers are located on the lower edge of your GPIB board. Refer to the appropriate parts locator diagram, Figure 2-2 or 2-3.
3. Change the jumper settings to configure the GPIB board to the new interrupt request line.

To use lines 10, 11, 12, or 15, use the jumper block shown in Figure 2-5. To use interrupt lines 3, 4, 5, 7, or 9, use the jumper block shown in Figure 2-6. To disable interrupts, use the jumper setting shown in Figure 2-7.

Figure 2-5 shows the setting for IRQ11.

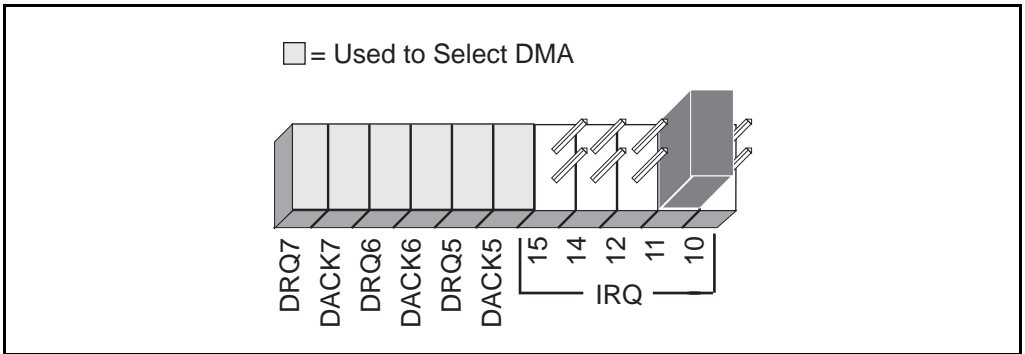

Figure 2-5. Interrupt Jumper Setting for IRQ11 (Default Setting)

Figure 2-6 shows the setting for IRQ5.

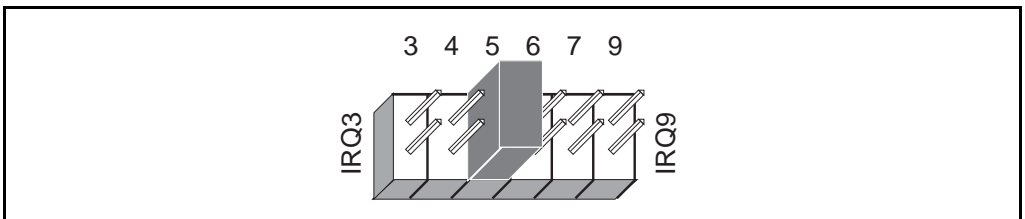

Figure 2-6. Interrupt Jumper Setting for IRQ5

If you do not want to use interrupts, you can disable interrupt levels on the GPIB board by setting the jumper as shown in Figure 2-7.

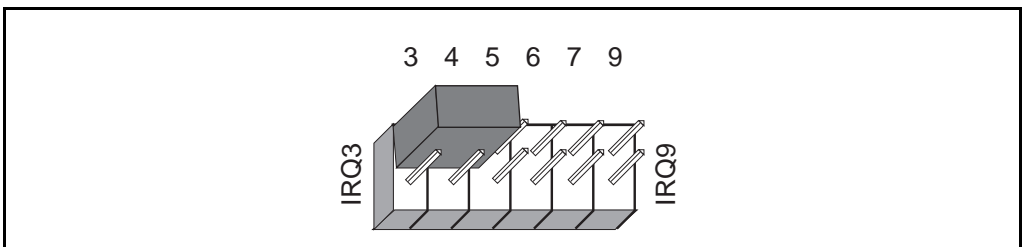

Figure 2-7. Jumper Setting for Disabling Interrupts



4. Record your new setting on the *GPIB Board Hardware and Software Configuration Form* in Appendix B, *Customer Communication*.
5. Remember that after you install the NI-488.2 software, you must use the `ibconf` utility to configure your software settings to match your new hardware settings. Refer to the *Configure the Software with ibconf* section in Chapter 3, *Software Installation and Configuration*, for information on `ibconf`.

## Selecting the DMA Channel

Direct memory access (DMA) refers to data transfers directly to or directly from devices such as the GPIB board and computer memory. Your GPIB hardware and the NI-488.2 software are designed to perform DMA. In most cases, data transfers using DMA are significantly faster than programmed I/O transfers, which use more CPU time.

By default, the GPIB board is configured to use DMA channel 5. If this is not an acceptable setting or if you are installing more than one board, follow these steps to reconfigure the DMA channel.

**Note:** *If you have installed the AT-GPIB/TNT board in an 8-bit (PC-style) slot, you must disable DMA, because DMA channels 5, 6, and 7 are 16-bit DMA channels. Refer to Figure 2-9, which shows how to set the DMA jumpers for no DMA. The AT-GPIB board can be installed only in a 16-bit slot.*

1. Choose a new DMA channel setting.

You can use channel 5, 6, or 7. If you are installing more than one GPIB board, each board must either use a unique DMA channel or must not use DMA at all.

2. Locate the jumpers that select the DMA channel. Refer to the appropriate parts locator diagram, Figure 2-2 or 2-3.
3. Change the jumper settings to configure the GPIB board to the new DMA channel. To select a new DMA channel, you must set both the DMA Acknowledge and DMA Request lines, as shown in Table 2-3.

Table 2-3. DMA Channels

DMA Channel	Signal Lines	
	DMA Acknowledge	DMA Request
5	DACK5	DRQ5
6	DACK6	DRQ6
7	DACK7	DRQ7

Figure 2-8 shows the jumper position for selecting DMA channel 7.

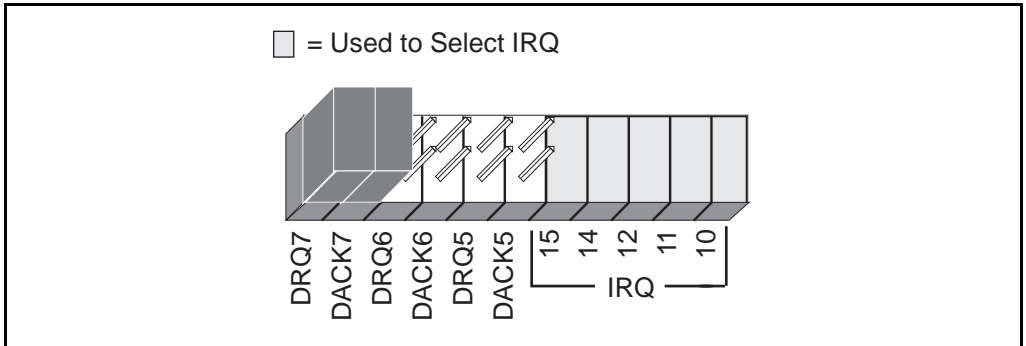

Figure 2-8. DMA Channel Jumper Setting for DMA Channel 7

4. Record your new setting on the *GPIB Board Hardware and Software Configuration Form* in Appendix B, *Customer Communication*.
5. Remember that after you install the NI-488.2 software, you must use the `ibconf` utility to configure your software setting to match your new hardware settings. Refer to the *Configure the Software with ibconf* section in Chapter 3, *Software Installation and Configuration*, for information on `ibconf`.

## Using Programmed I/O for GPIB Transfers

As an alternative to DMA transfers, you can use programmed I/O. To use programmed I/O, you should disable DMA for the GPIB board by moving the jumpers as shown in Figure 2-9.

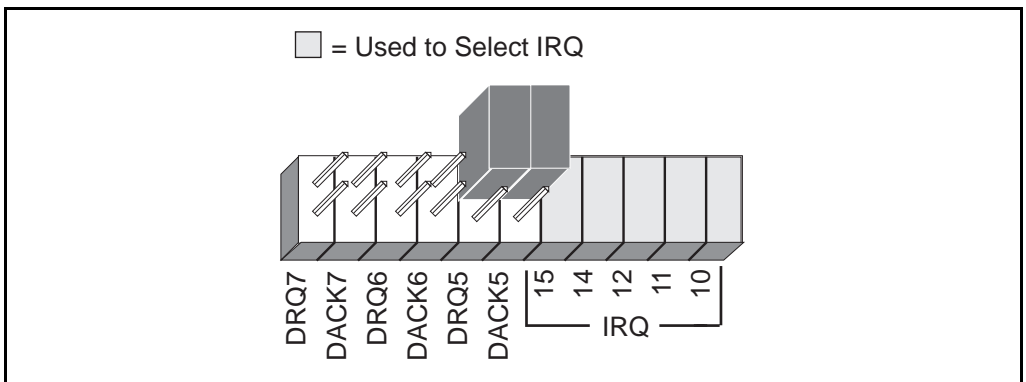

Figure 2-9. DMA Jumper Setting for No DMA Channel

## Setting the Shield Ground Configuration

The GPIB board is set at the factory with the jumper in place to connect the logic ground of the GPIB board to its shield ground. This configuration minimizes EMI emissions.

**Caution:** *The GPIB board was tested for compliance with FCC standards with the shield ground connected to logic ground. Removing the jumper might cause EMI emissions to exceed any or all of the applicable standards.*

If your application requires that logic ground be disconnected from shield ground, follow these steps:

1. Refer to Figure 2-2 to locate the shield ground jumper W3 on the AT-GPIB/TNT board. If you are using the AT-GPIB board, refer to Figure 2-3 to locate the shield ground jumper W1.
2. Remove the jumper and place it across only one of the jumper pins, as shown in Figure 2-10.

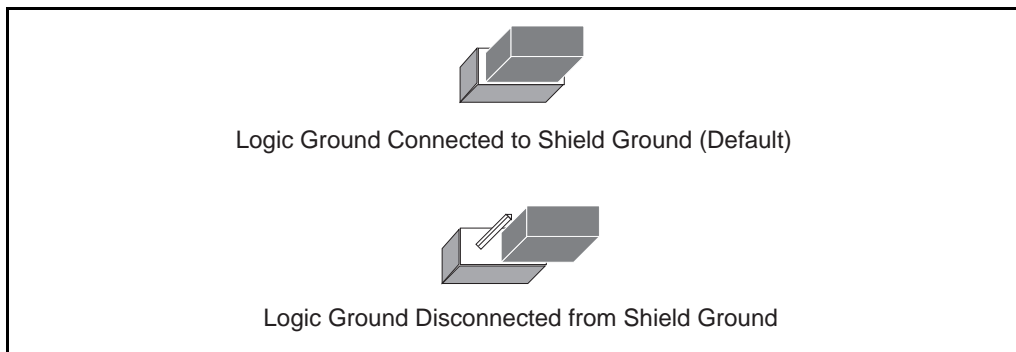

Figure 2-10. Ground Configuration Jumper Settings

3. Record the jumper setting on the *GPIB Board Hardware and Software Configuration Form* in Appendix B, *Customer Communication*.

Now that you have properly configured the hardware, return to the *Install the Hardware* section at the beginning of this chapter for the installation instructions.

# Chapter 3

## Software Installation and Configuration

---

This chapter contains instructions to help you install and configure your NI-488.2 software.

### NI-488.2 Software Components

The NI-488.2 software includes the following components:

- Device driver
- Hardware and software diagnostic tests
- Configuration utility
- Interactive control program
- Utilities for software development
- Language interface libraries for the following languages:
  - BASICA
  - GWBASIC
  - Microsoft QuickBASIC
  - Microsoft Professional BASIC
  - Microsoft Visual Basic for DOS
  - Microsoft C
- Example programs that use NI-488 functions and NI-488.2 routines

For a detailed list of files, refer to the *NI-488.2 User Manual for DOS*.

### Install the Software

After you have installed and configured the hardware, you are ready to install the NI-488.2 software. Complete the following steps to run the software installation program.

1. Insert the NI-488.2 software for DOS distribution disk into an unused drive.
2. Begin the software installation by entering the following command:

```
x:\install
```

where *x* is the letter of the drive containing the distribution disk (usually a or b).

The software installation begins with the following screen:

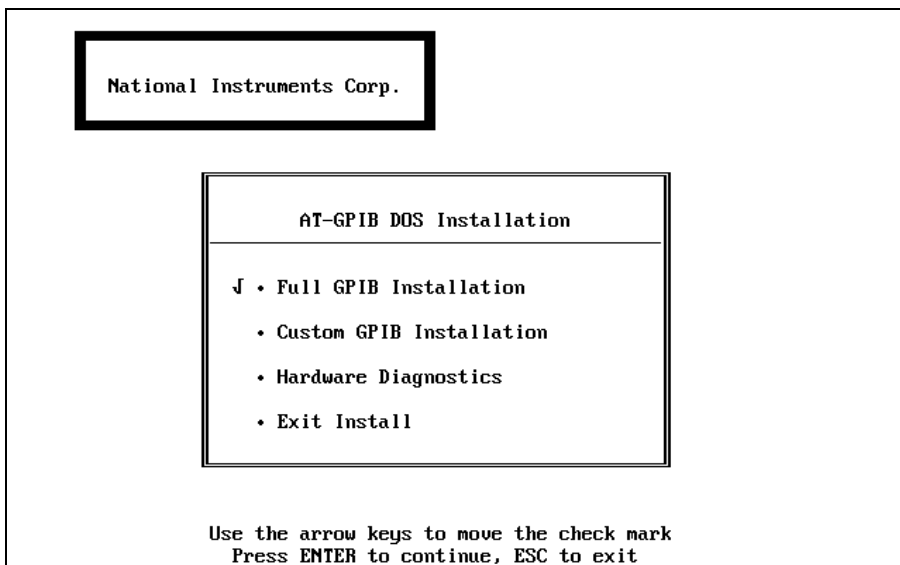

3. Select the type of installation you want.
  - Selecting Full GPIB Installation installs all NI-488.2 software files on your hard drive.
  - Selecting Custom GPIB Installation lets you select the parts of the NI-488.2 software to install on your hard drive.
  - Selecting Hardware Diagnostics executes the hardware diagnostics program `ibdiag`. You must know your hardware configuration to run `ibdiag`. If the hardware diagnostics fail, refer to Chapter 4, *Installation Verification and Troubleshooting*, for information on `ibdiag`.

You can use the escape key <ESC> at any time to abort the installation.

4. After the installation is complete, reboot your computer.

To load the NI-488.2 driver for DOS, you must reboot your computer. If the installation is successful, the driver displays a banner message on your screen when DOS loads the driver.

After you have installed your software, you might want to view or modify the driver configuration. If you modified the hardware configuration or if you installed more than one GPIB board, you must reconfigure the software. Refer to the next section for instructions on running the configuration utility `ibconf`. If you do not need to run `ibconf`, refer to Chapter 4, *Installation Verification and Troubleshooting*, for instructions on verifying the hardware and software installation.

## Configure the Software with `ibconf`

`ibconf` is an interactive utility you can use to examine or modify the configuration of the driver. You must run `ibconf` if you changed any of the hardware default settings or if you installed more than one GPIB board.

To run `ibconf`, go to the directory where the NI-488.2 software is installed, and enter the following command:

```
ibconf
```

After you enter `ibconf`, use the cursor keys and help information to examine the settings and make any necessary changes. To exit `ibconf`, press <Esc> or the function key <F9> and save your changes.

For more information about `ibconf`, refer to the *NI-488.2 User Manual for DOS*.

After you have installed and configured the software, you should reboot your computer and then verify the installation. Refer to Chapter 4, *Installation Verification and Troubleshooting*.

# Chapter 4

## Installation Verification and Troubleshooting

---

This chapter describes how to verify the hardware and software installation and how to troubleshoot problems.

### Run the Hardware Diagnostic Program

To verify and test the hardware installation, run the `ibdiag` hardware diagnostic program that came with your NI-488.2 software. `ibdiag` verifies that your hardware is functioning properly and that the configuration of your board does not conflict with anything else in your system.

Follow these steps to run `ibdiag`:

1. Disconnect any GPIB cables.
2. Go to the directory where the software is installed (for example, `c:\at-gpib`).
3. Enter the following command:

```
ibdiag
```

If `ibdiag` completes with no errors, your hardware is functioning properly. If `ibdiag` returns an error message, refer to the next section for troubleshooting instructions.

### Troubleshooting `ibdiag` Error Messages

First verify that all GPIB cables are disconnected and make sure that the switch and jumper settings on the hardware match the values you entered for `ibdiag`.

#### Using Single-cycle DMA

The GPIB board normally uses demand-mode DMA. If your computer cannot use demand-mode DMA, `ibdiag` prints a message telling you to use single-cycle DMA. You can select single-cycle DMA by configuring the software using `ibconf`. Refer to the *Configure the Software with `ibconf`* section of Chapter 3, *Software Installation and Configuration*, for information on `ibconf`.

## Correcting Hardware Settings

Follow these steps to troubleshoot `ibdiag` error messages.

1. Make sure you are using a valid base I/O address.

Run `ibdiag` again. When it prompts you for values, enter your base I/O address, but enter `<N>` for both the interrupt request line and the DMA channel. If `ibdiag` fails again, one of the following situations is occurring:

- The base address that you entered at the `ibdiag` prompt does not match the switch settings of the board. Check the switch settings again.
- A GPIB cable is connected to the board. Remove all GPIB cables before running `ibdiag` again.
- Another board or built-in device in your computer is using the same address space. Change the base I/O address of your GPIB board and repeat this step using the new setting.
- The board is defective or cannot operate in your computer. Complete the *Technical Support Form* in Appendix B, *Customer Communication*, and contact National Instruments.

2. Make sure you are using a valid interrupt request line.

Run `ibdiag` again. When it prompts you for values, enter the valid base I/O address as determined in Step 1, the interrupt request line, and `<N>` for the DMA channel. If `ibdiag` fails, one of the following situations is occurring:

- The interrupt request line that you entered at the `ibdiag` prompt does not match the jumper setting of the board. Check the jumper setting again.
- Another board or built-in device in your computer is using the same interrupt request line. Change the interrupt request line of the GPIB board and repeat this step using the new setting.
- The board is defective or cannot operate in your computer. Complete the *Technical Support Form* in Appendix B, *Customer Communication*, and contact National Instruments.

3. Make sure you are using a valid DMA channel.

Run `ibdiag` again. When it prompts you for values, enter the valid base I/O address and interrupt request line as determined in Steps 1 and 2, and enter the current DMA channel. If `ibdiag` fails, one of the following situations is occurring:

- The DMA channel that you entered at the `ibdiag` prompt does not match the jumper setting of the board. Check the jumper setting again.



- Another board or built-in device in your computer is using the same DMA channel. Change the DMA channel of the GPIB board and repeat this step using the new setting.
- The board is defective or cannot operate in your computer. Complete the *Technical Support Form* in Appendix B, *Customer Communication*, and contact National Instruments.

## Run the Software Diagnostic Program

To verify and test the hardware and software installation, run the `ibtest` software diagnostic program that came with your NI-488.2 software. The `ibtest` program is an NI-488.2 application that makes calls to the driver just as your application does.

Follow these steps to run `ibtest`:

1. Disconnect any GPIB cables.
2. Go to the directory where the software is installed (for example, `c:\at-gpib`).
3. Enter the following command:

```
ibtest
```

If `ibtest` completes with no errors, you have installed the NI-488.2 software correctly. If `ibtest` returns an error message, refer to the next section for troubleshooting instructions.

## Troubleshooting `ibtest` Error Messages

The following sections explain common error messages generated by `ibtest`.

The `ibtest` program may lock up your computer if the GPIB board under test is configured to use an incorrect interrupt level. If `ibtest` locks up, you can either reconfigure the hardware to use a different interrupt level or use `ibconf` to disable interrupts. For detailed instructions, refer to the sections *Configure the Hardware* in Chapter 2 and *Configure the Software with `ibconf`* in Chapter 3.

**Note:** *In the following paragraphs, `gpibx` refers to board `gpib0`, `gpib1`, `gpib2`, or `gpib3` as appropriate.*

### Presence Test of Driver

The `ibtest` program tests for the presence of the NI-488.2 driver. `ibtest` displays the following message if it detects a problem:

```
<<< No handler present for GPIBx. >>>
```

If this message appears, make sure that the GPIB driver is installed. Check that the following line is in your `config.sys` file:

```
device = drive:\path\gpib.com
```

where *drive* is the drive where the NI-488.2 software is installed (usually `c:`) and *path* is the directory path on the drive to the NI-488.2 software (for example, `at-gpib`).

### Presence Test of Board

The following error message appears if `gpibx` is not installed or if the software is not configured properly:

```
<<< No board present for GPIBx. >>>
```

If this message appears, you could have one of the following situations:

- The Use this GPIB Interface field in `ibconf` might be set to `no` for board `gpibx`. If you want to use the board, you must set this field to `yes`.
- The board might not be properly installed and configured. Refer to *Configure the Hardware* section in Chapter 2, *Hardware Configuration and Installation*, for detailed instructions.
- The software and hardware settings do not match. You can run `ibconf` to check the current configuration of the software.

### GPIB Cables Connected

The following error message appears if a GPIB cable is connected to the board when you run `ibtest`:

```
Call(25) 'ibcmd " "' failed, ibsta (0x134) not what was expected  
(0x8130)
```

```
Call(25) 'ibcmd " "' failed, expected ibsta (0x100) to have the ERR  
bit set.
```

Disconnect all GPIB cables before trying the test again.

### ULI Driver Loaded

If you try to use NI-488 functions or NI-488.2 routines or run `ibtest` with the ULI driver `uli.com` loaded, the following error message appears and your computer might lock up.

### Syntax Error

While the ULI driver is loaded, you cannot use the standard NI-488 functions or NI-488.2 routines. Reboot your computer so that the ULI driver is not loaded. If your `autoexec.bat` file loads `uli.com`, change the line that loads `uli.com` to a comment before rebooting your computer.

## Common Questions

### Which NI-488.2 software (DOS or Windows) do I need to install?

If you want to run a GPIB application under DOS, install the NI-488.2 software for DOS. If you want to run a GPIB application in Windows, you must install the NI-488.2 software for Windows.

### Can I have the NI-488.2 software for DOS and Windows drivers installed at the same time?

Yes, there is nothing wrong with installing both. However, it is better not to use them at the same time.

### How can I determine which type of GPIB board I have installed?

Run the `GPIBInfo` utility. If you run `GPIBInfo` without specifying any parameters, it returns information about the GPIB boards currently configured for use in your system. If you know the base I/O address of a GPIB interface board, you can enter it as a parameter for specific information. For example, `GPIBInfo 2C0` returns information about the GPIB board at base I/O address 2C0. For more information about `GPIBInfo`, refer to the *NI-488.2 User Manual for DOS*.

### How can I determine which version of the NI-488.2 software I have installed?

Run the `GPIBInfo` utility. If you run `GPIBInfo` without specifying any parameters, it returns information about the version of the NI-488.2 software currently installed. For more information about `GPIBInfo`, refer to the *NI-488.2 User Manual for DOS*.

### What do I do if `ibdiag` or `ibtest` fails with an error?

Refer to the troubleshooting sections of this chapter for specific information about what might cause these tests to fail.

**When should I use `ibic`?**

You can use `ibic` to test and verify instrument communication, troubleshoot problems, and develop your application program. For more information about `ibic`, refer to Chapter 5, *ibic—Interface Bus Interactive Control Utility*, in the *NI-488.2 User Manual for DOS*.

**How do I use an NI-488.2 language interface?**

For information about using NI-488.2 language interfaces, refer to Chapter 3, *Developing Your Application*, in the *NI-488.2 User Manual for DOS*.

**What information should I have before I call National Instruments?**

When you call National Instruments, you should have the results of the diagnostic tests `ibdiag` and `ibtest` and the output from `GPiBInfo`. Also, make sure you have filled out the configuration form in Appendix B, *Customer Communication*.

# Chapter 5

## Using Your NI-488.2 Software

---

This chapter describes the `ibic` utility and lists some programming considerations.

### Introduction to `ibic`

You can use `ibic`, the Interface Bus Interactive Control utility, to enter NI-488 functions and NI-488.2 routines interactively and to display the results of the function calls automatically. Without writing an application, you can use `ibic` to do the following:

- Verify GPIB communication with your device quickly and easily.
- Learn the NI-488 functions and NI-488.2 routines before you write your application.
- Become familiar with the commands of your device.
- Receive data from your GPIB device.
- Learn new NI-488.2 routines before integrating them into your application.
- Troubleshoot problems with your application.

For more information about `ibic`, refer to the *NI-488.2 User Manual for DOS*.

### General Programming Considerations

As you begin developing your NI-488.2 application, remember the following points:

- You must link the language interface library with your compiled source code.
- You must include the header file in your source code.

For information about choosing a programming method, developing your application, or compiling and linking, refer to the *NI-488.2 User Manual for DOS*. For detailed information about each NI-488 function and NI-488.2 routine, refer to the *NI-488.2 Function Reference Manual for DOS/Windows*.

# Appendix A

## Hardware Specifications

---

This appendix describes the physical characteristics of the GPIB board and the recommended operating conditions.

Table A-1. Electrical Characteristics for the AT-GPIB/TNT

Characteristic	Specification
Maximum GPIB Transfer Rates 3-wire (IEEE 488)	1.5 Mbytes/s*
High Speed (HS488) In ISA computer In EISA computer	1.6 Mbytes/s* 3.4 Mbytes/s*
Power Requirement (from PC AT I/O channel)	+5 VDC 50 mA Typical 120 mA Maximum
* Actual speed may vary considerably from speed shown due to system and instrumentation capabilities.	

Table A-2. Electrical Characteristics for the AT-GPIB

Characteristic	Specification
Maximum GPIB Transfer Rates GPIB Reads GPIB Writes	over 1 Mbytes/s* over 1 Mbytes/s*
Power Requirement (from PC AT I/O channel)	+5 VDC .66 A Typical 1.5 A Maximum
* Actual speed may vary considerably from speed shown due to system and instrumentation capabilities.	

Table A-3. Physical Characteristics

<b>Characteristic</b>	<b>Specification</b>
Dimensions	10.67cm. by 16.51 cm. (4.2 in. by 6.5 in.)
I/O Connector	IEEE 488 Standard 24-pin

Table A-4. Environmental Characteristics

<b>Characteristic</b>	<b>Specification</b>
Operating Environment Component Temperature Relative Humidity	0° to 40° C 10% to 90%, noncondensing
Storage Environment Temperature Relative Humidity	-20° to 70° C 5% to 90%, noncondensing
EMI	FCC Class B Certified

# Appendix B

## Customer Communication

---

For your convenience, this appendix contains forms to help you gather the information necessary to help us solve technical problems and a form you can use to comment on the product documentation. When you contact us, we need the information on the Technical Support Form and the configuration form, if your manual contains one, about your system configuration to answer your questions as quickly as possible.

National Instruments has technical assistance through electronic, fax, and telephone systems to quickly provide the information you need. Our electronic services include a bulletin board service, an FTP site, a Fax-on-Demand system, and e-mail support. If you have a hardware or software problem, first try the electronic support systems. If the information available on these systems does not answer your questions, we offer fax and telephone support through our technical support centers, which are staffed by application engineers.

### Electronic Services

#### Bulletin Board Support

National Instruments has BBS and FTP sites dedicated for 24-hour support with a collection of files and documents to answer most common customer questions. From these sites, you can also download the latest instrument drivers, updates, and example programs. For recorded instructions on how to use the bulletin board and FTP services and for BBS automated information, call (512) 795-6990. You can access these services at:

United States: (512) 794-5422

Up to 14,400 baud, 8 data bits, 1 stop bit, no parity

United Kingdom: 01635 551422

Up to 9,600 baud, 8 data bits, 1 stop bit, no parity

France: 01 48 65 15 59

Up to 9,600 baud, 8 data bits, 1 stop bit, no parity

#### FTP Support

To access our FTP site, log on to our Internet host, `ftp.natinst.com`, as anonymous and use your Internet address, such as `joesmith@anywhere.com`, as your password. The support files and documents are located in the `/support` directories.



## **Fax-on-Demand Support**

Fax-on-Demand is a 24-hour information retrieval system containing a library of documents on a wide range of technical information. You can access Fax-on-Demand from a touch-tone telephone at (512) 418-1111.

## **E-Mail Support (currently U.S. only)**

You can submit technical support questions to the applications engineering team through e-mail at the Internet address listed below. Remember to include your name, address, and phone number so we can contact you with solutions and suggestions.

[support@natinst.com](mailto:support@natinst.com)

## **Telephone and Fax Support**

National Instruments has branch offices all over the world. Use the list below to find the technical support number for your country. If there is no National Instruments office in your country, contact the source from which you purchased your software to obtain support.

	<b>Telephone</b>	<b>Fax</b>
Australia	03 9879 5166	03 9879 6277
Austria	0662 45 79 90 0	0662 45 79 90 19
Belgium	02 757 00 20	02 757 03 11
Canada (Ontario)	905 785 0085	905 785 0086
Canada (Quebec)	514 694 8521	514 694 4399
Denmark	45 76 26 00	45 76 26 02
Finland	09 725 725 11	09 725 725 55
France	01 48 14 24 24	01 48 14 24 14
Germany	089 741 31 30	089 714 60 35
Hong Kong	2645 3186	2686 8505
Israel	03 5734815	03 5734816
Italy	02 413091	02 41309215
Japan	03 5472 2970	03 5472 2977
Korea	02 596 7456	02 596 7455
Mexico	5 520 2635	5 520 3282
Netherlands	0348 433466	0348 430673
Norway	32 84 84 00	32 84 86 00
Singapore	2265886	2265887
Spain	91 640 0085	91 640 0533
Sweden	08 730 49 70	08 730 43 70
Switzerland	056 200 51 51	056 200 51 55
Taiwan	02 377 1200	02 737 4644
U.K.	01635 523545	01635 523154

# Technical Support Form

---

Photocopy this form and update it each time you make changes to your software or hardware, and use the completed copy of this form as a reference for your current configuration. Completing this form accurately before contacting National Instruments for technical support helps our applications engineers answer your questions more efficiently.

If you are using any National Instruments hardware or software products related to this problem, include the configuration forms from their user manuals. Include additional pages if necessary.

Name \_\_\_\_\_

Title \_\_\_\_\_

Company \_\_\_\_\_

Address \_\_\_\_\_

Fax ( \_\_\_\_\_ ) \_\_\_\_\_ Phone ( \_\_\_\_\_ ) \_\_\_\_\_

Computer brand \_\_\_\_\_ Model \_\_\_\_\_ Processor \_\_\_\_\_

Operating system (include version number) \_\_\_\_\_

Clock Speed \_\_\_\_\_ MHz RAM \_\_\_\_\_ MB Display adapter \_\_\_\_\_

Mouse \_\_\_\_\_yes \_\_\_\_\_ no Other adapters installed \_\_\_\_\_

Hard disk capacity \_\_\_\_\_ MB Brand \_\_\_\_\_

Instruments used \_\_\_\_\_

National Instruments hardware product model \_\_\_\_\_ Revision \_\_\_\_\_

Configuration \_\_\_\_\_

National Instruments software product \_\_\_\_\_ Version \_\_\_\_\_

Configuration \_\_\_\_\_

The problem is \_\_\_\_\_

\_\_\_\_\_

\_\_\_\_\_

List any error messages \_\_\_\_\_

\_\_\_\_\_

\_\_\_\_\_

The following steps will reproduce the problem \_\_\_\_\_

\_\_\_\_\_

\_\_\_\_\_

# GPIB Board Hardware and Software Configuration Form

---

Record the settings and revisions of your hardware and software on the line to the right of each item. Update this form each time you revise your software or hardware configuration, and use this form as a reference for your current configuration.

## National Instruments Products

- GPIB Board and Revision Number
  - AT-GPIB/TNT Board Revision \_\_\_\_\_
  - or
  - AT-GPIB Board Revision \_\_\_\_\_
- NI-488.2 Software Revision Number on Distribution Disk(s) \_\_\_\_\_
- Programming Language Interface Revision \_\_\_\_\_
- Shield Ground Connected to Logic Ground (yes or no) \_\_\_\_\_
- Board Settings

	Base I/O Address	Interrupt Level	DMA Channel
gpib0	_____	_____	_____
gpib1	_____	_____	_____
gpib2	_____	_____	_____
gpib3	_____	_____	_____

(continues)

## Other Products

- Computer Make and Model \_\_\_\_\_
- Microprocessor \_\_\_\_\_
- Clock Frequency \_\_\_\_\_
- Type of Monitor Card Installed \_\_\_\_\_
- DOS Version \_\_\_\_\_
- Application Programming Language (BASICA, Microsoft C, and so on) \_\_\_\_\_  
\_\_\_\_\_
- Other Boards in System \_\_\_\_\_
- Base I/O Address of Other Boards \_\_\_\_\_
- Interrupt Level of Other Boards \_\_\_\_\_
- DMA Channels of Other Boards \_\_\_\_\_

# Documentation Comment Form

---

National Instruments encourages you to comment on the documentation supplied with our products. This information helps us provide quality products to meet your needs.

Title: **Getting Started with Your AT-GPIB/TNT and the NI-488.2™ Software for DOS**

Edition Date: **June 1997**

Part Number: **320718C-01**

Please comment on the completeness, clarity, and organization of the manual.

---

---

---

---

---

---

---

---

---

---

---

---

---

---

---

---

---

---

---

---

---

---

---

---

---

---

(continues)

If you find errors in the manual, please record the page numbers and describe the errors.

---

---

---

---

---

---

---

---

---

---

---

---

---

---

---

---

---

---

---

---

---

---

---

---

Thank you for your help.

Name \_\_\_\_\_

Title \_\_\_\_\_

Company \_\_\_\_\_

Address \_\_\_\_\_

Phone ( \_\_\_\_\_ ) \_\_\_\_\_

Mail to:      Technical Publications  
                 National Instruments Corporation  
                 6504 Bridge Point Parkway, MS 53-02  
                 Austin, TX 78730-5039

Fax to:        Technical Publications  
                 National Instruments Corporation  
                 MS 53-02  
                 (512) 794-5678

# Glossary

---

Prefix	Meaning	Value
m-	milli-	$10^{-3}$
c-	centi-	$10^{-2}$
k-	kilo-	$10^3$
M-	mega-	$10^6$

°	degrees
%	percent
A	amperes
AC	alternating current
ANSI	American National Standards Institute
ASIC	application-specific integrated circuit
BIOS	Basic Input/Output System
C	Celsius
CPU	central processing unit
DIP	dual inline package
DMA	direct memory access
EISA	Extended Industry Standard Architecture
EMI	electromagnetic interference
FCC	Federal Communications Commission
GPIB	General Purpose Interface Bus
hex	hexadecimal
Hz	hertz
I/O	input/output
IEEE	Institute of Electrical and Electronic Engineers
in.	inches
IRQ	interrupt request
ISA	Industry Standard Architecture
KB	kilobytes of memory
m	meters
MB	megabytes of memory
PC	personal computer
RAM	random-access memory
s	seconds
VDC	volts direct current