

SCALE 1/2

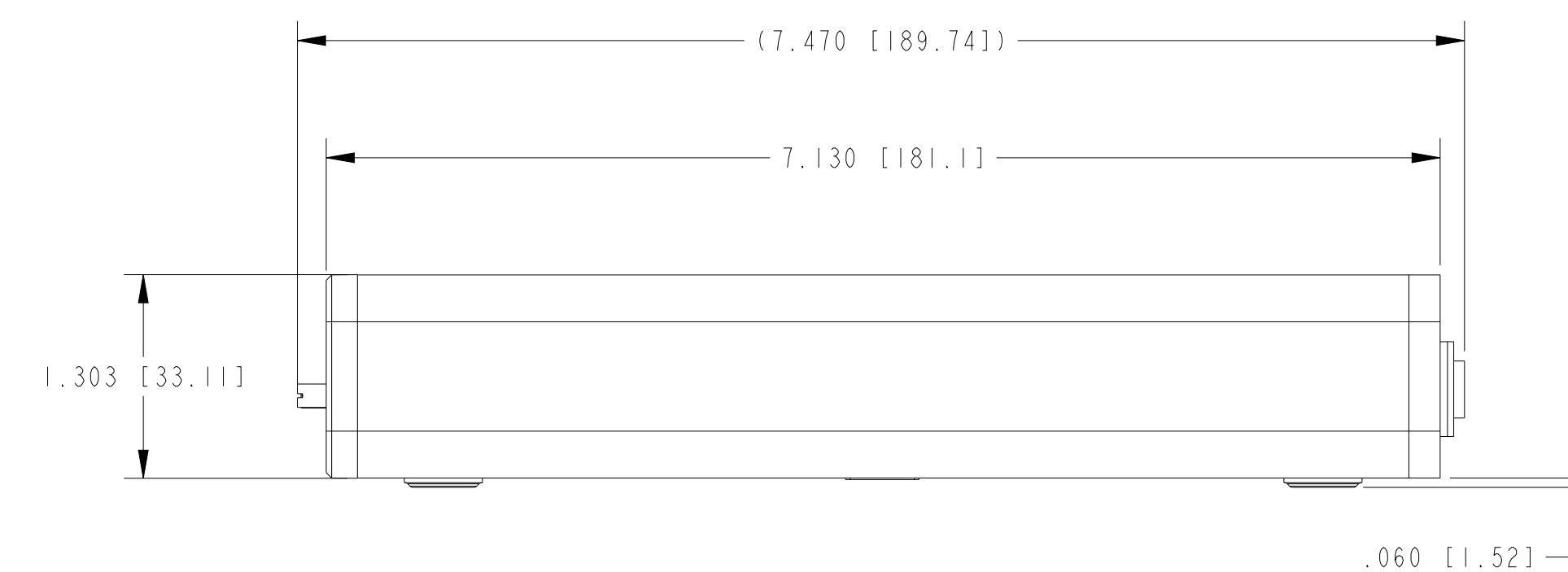
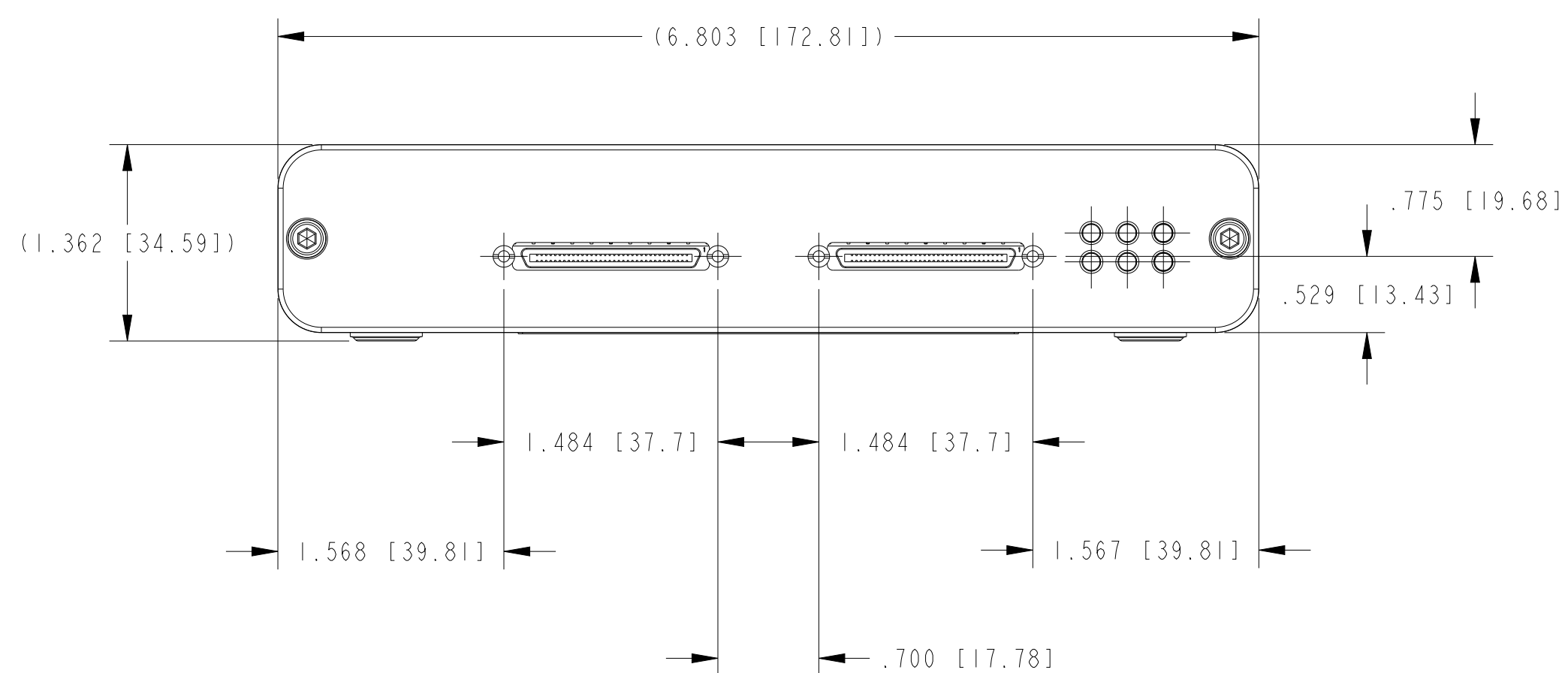
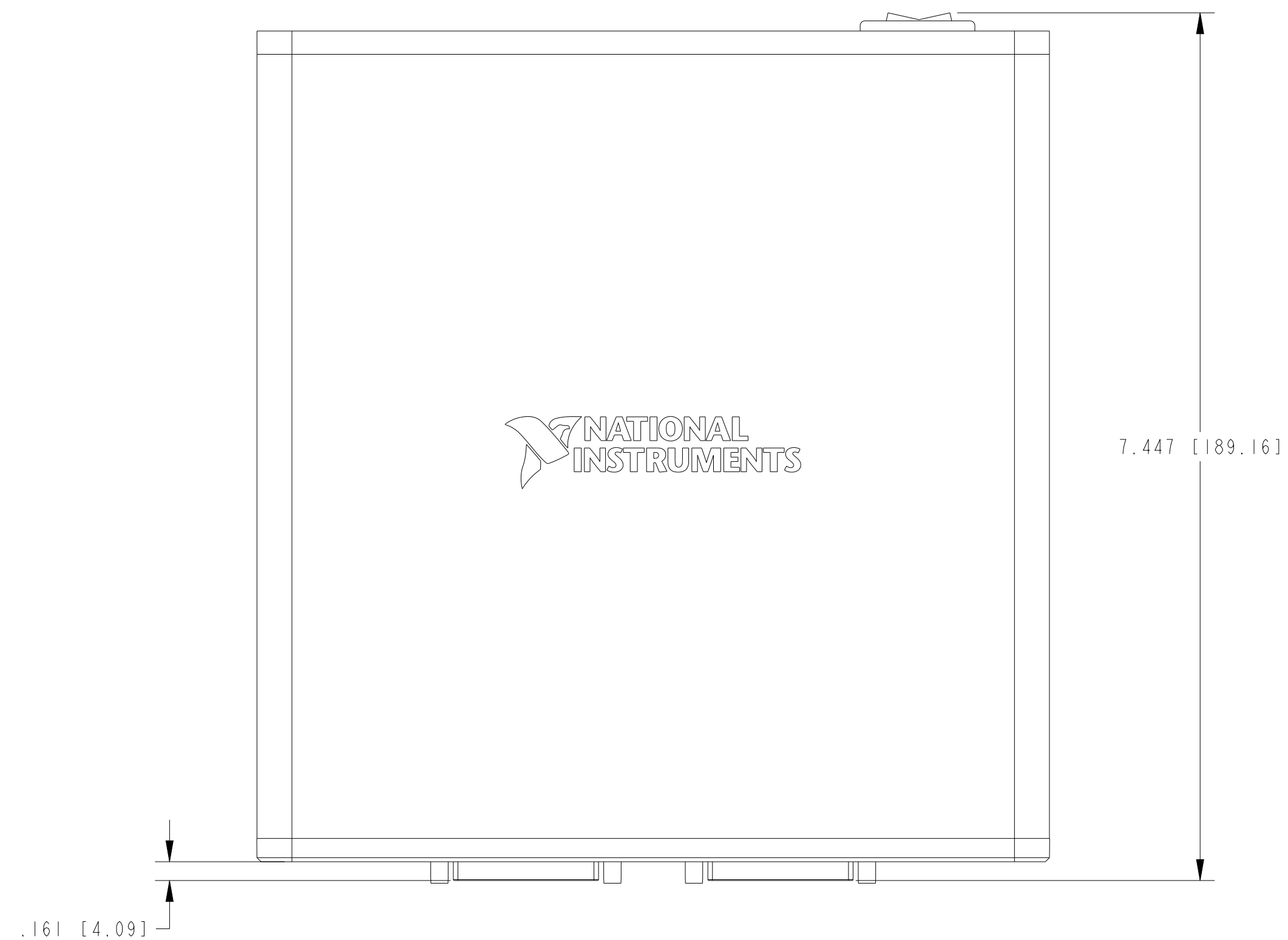

1. REFER TO PRODUCT MANUAL ON NI.COM FOR MORE DETAILS
 NOTES: UNLESS OTHERWISE SPECIFIED.

UNLESS OTHERWISE SPECIFIED DIMENSIONS ARE IN INCHES AND [MILLIMETERS].	NATIONAL INSTRUMENTS® AUSTIN, TEXAS	
	TITLE	
DO NOT SCALE DRAWING THIRD ANGLE PROJECTION		NI USB-7846R
	SIZE CODE IDENT NO. MM/DD/YYYY	D 7U296 11/21/2013
	SCALE: 1/1	SHEET 1 OF 1