

4

3

2

1

COPYRIGHT ©2012
NATIONAL INSTRUMENTS CORPORATION AND ITS LICENSORS. ALL RIGHTS RESERVED.

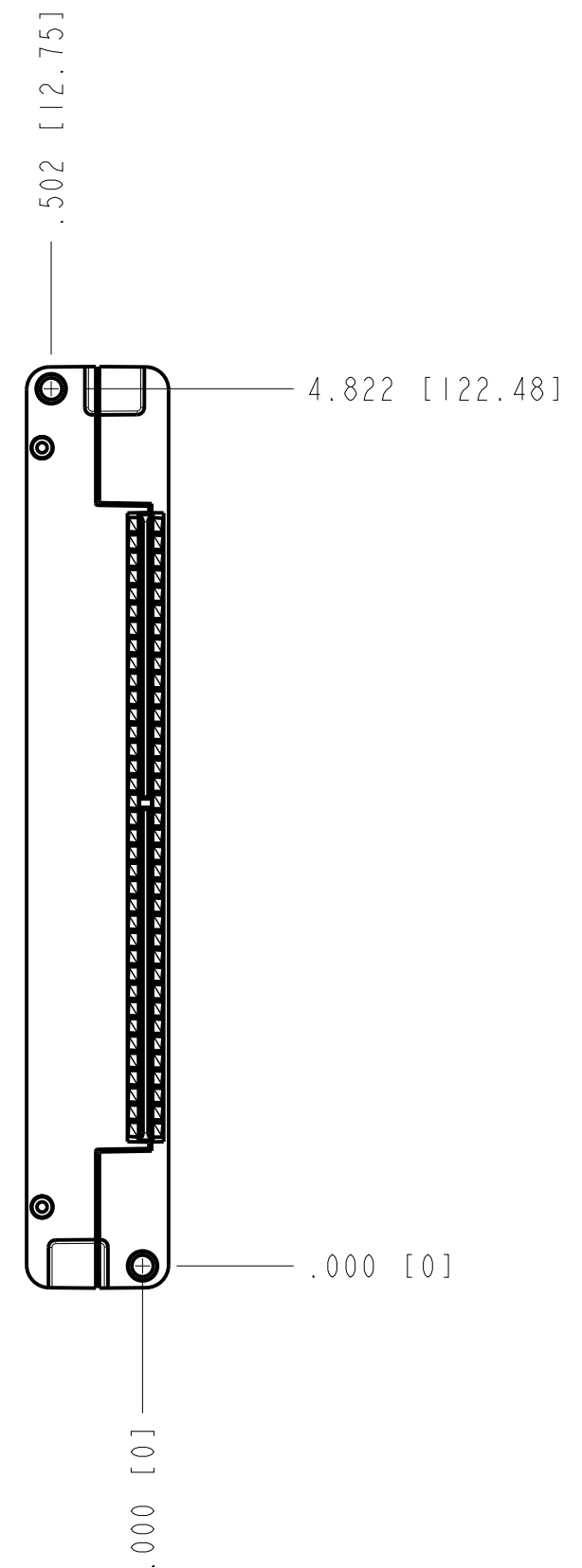
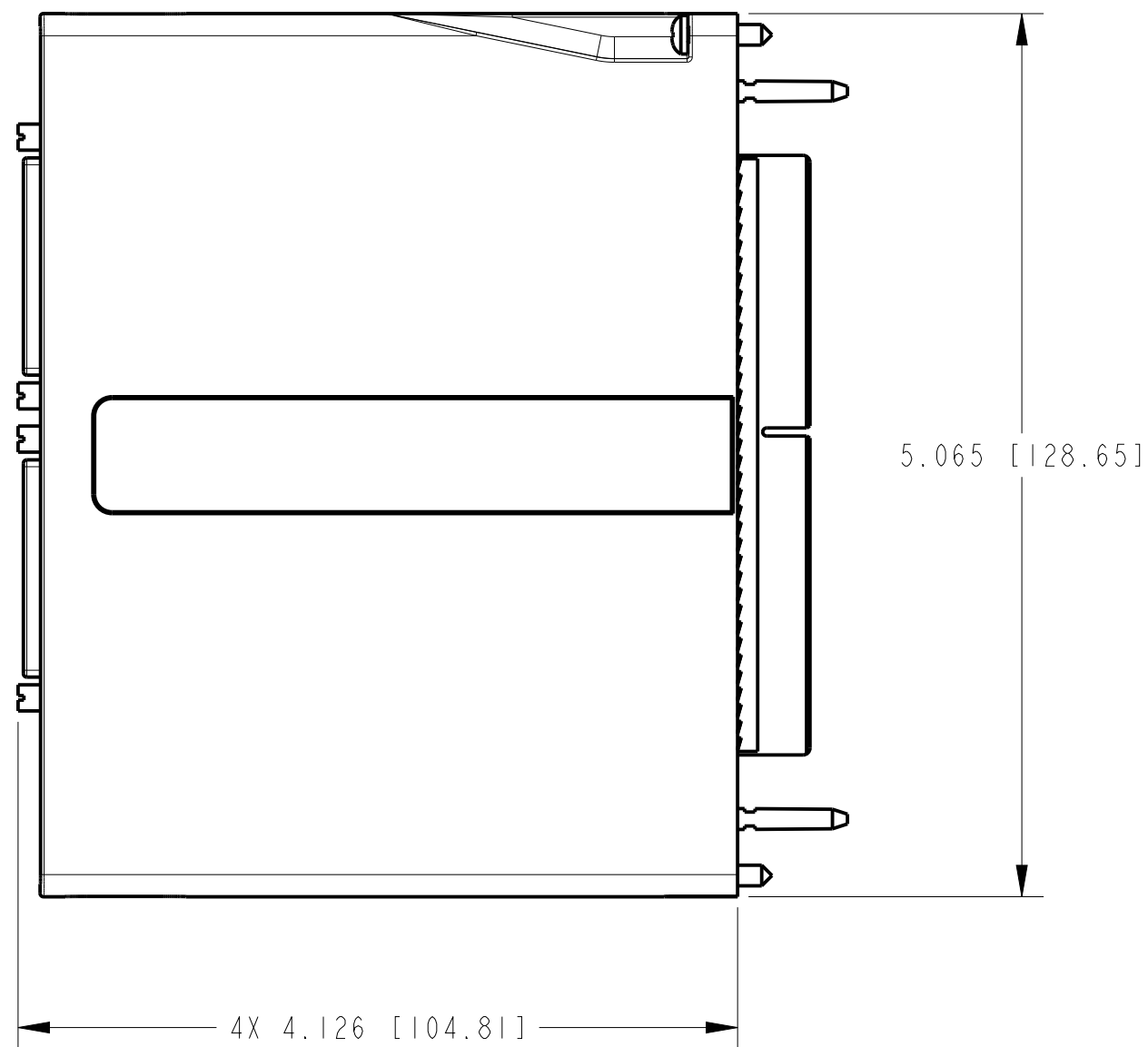
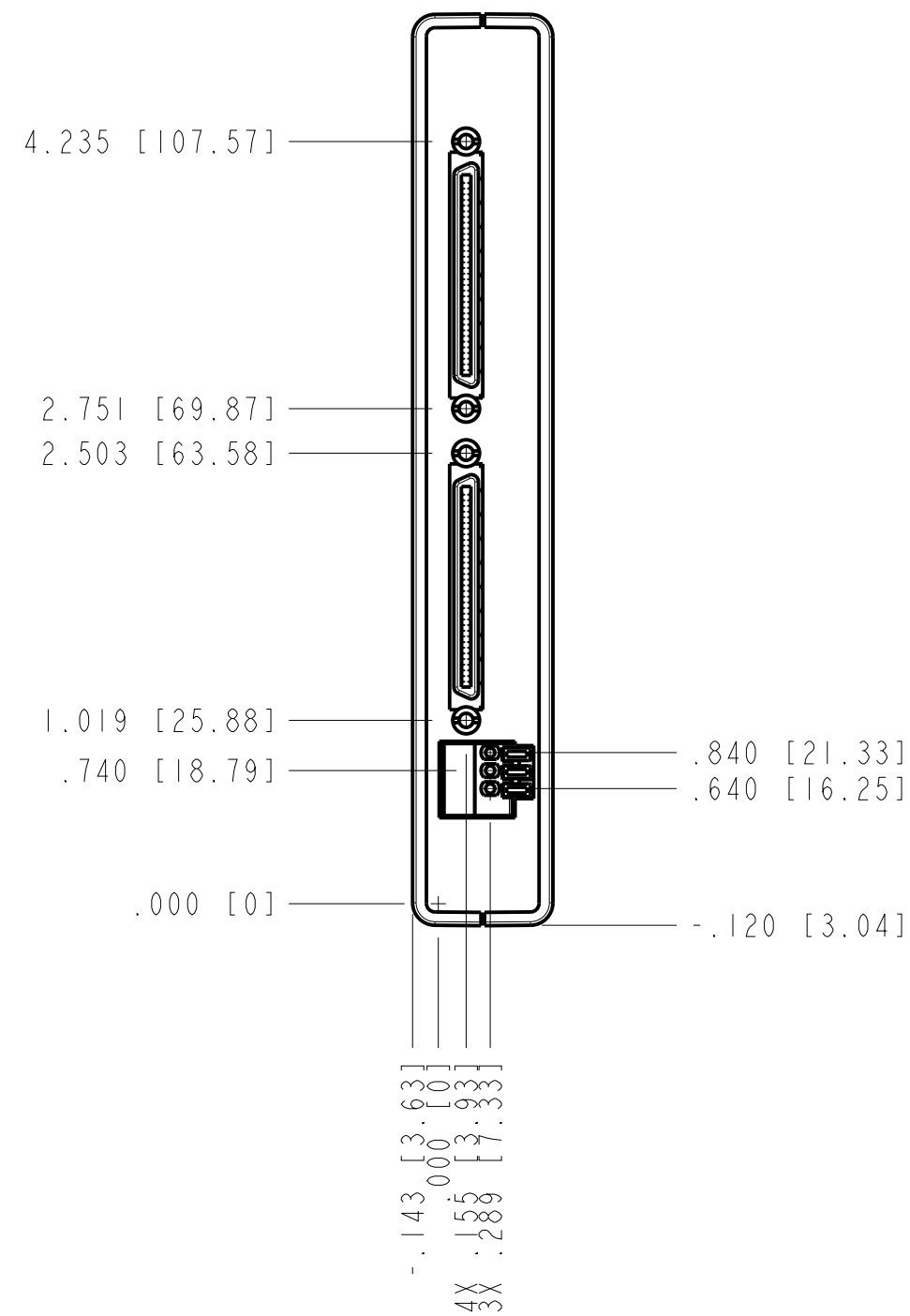
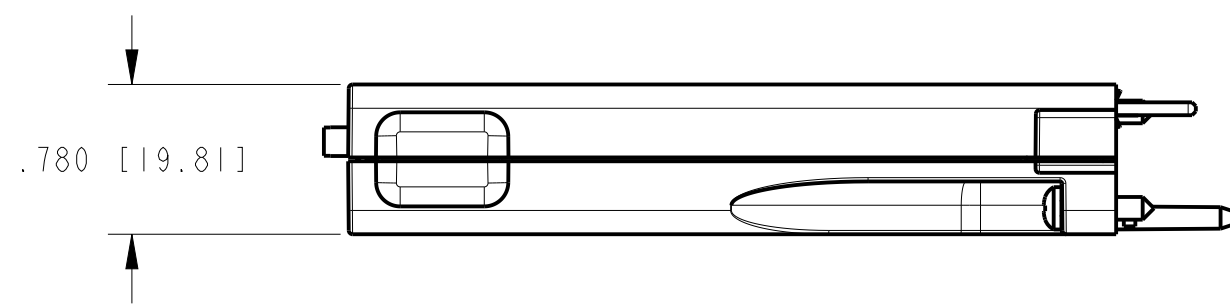

CUSTOMER DRAWING

UNLESS OTHERWISE SPECIFIED
DIMENSIONS ARE IN INCHES AND
[MILLIMETERS].

DO NOT SCALE DRAWING

THIRD ANGLE PROJECTION

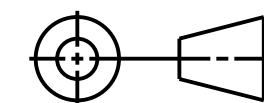

AUSTIN, TEXAS

TITLE

NI 6581

SIZE CODE IDENT NO. MM/DD/YYYY

C7U296

01/12/2012

SCALE: 1/1

SHEET 1 OF 1

4

3

2

1

D

D

C

C

B

B

A

A