

4

3

2

1

COPYRIGHT ©2011
NATIONAL INSTRUMENTS CORPORATION AND ITS LICENSORS. ALL RIGHTS RESERVED.

D

D

C

C

B

B

A

A

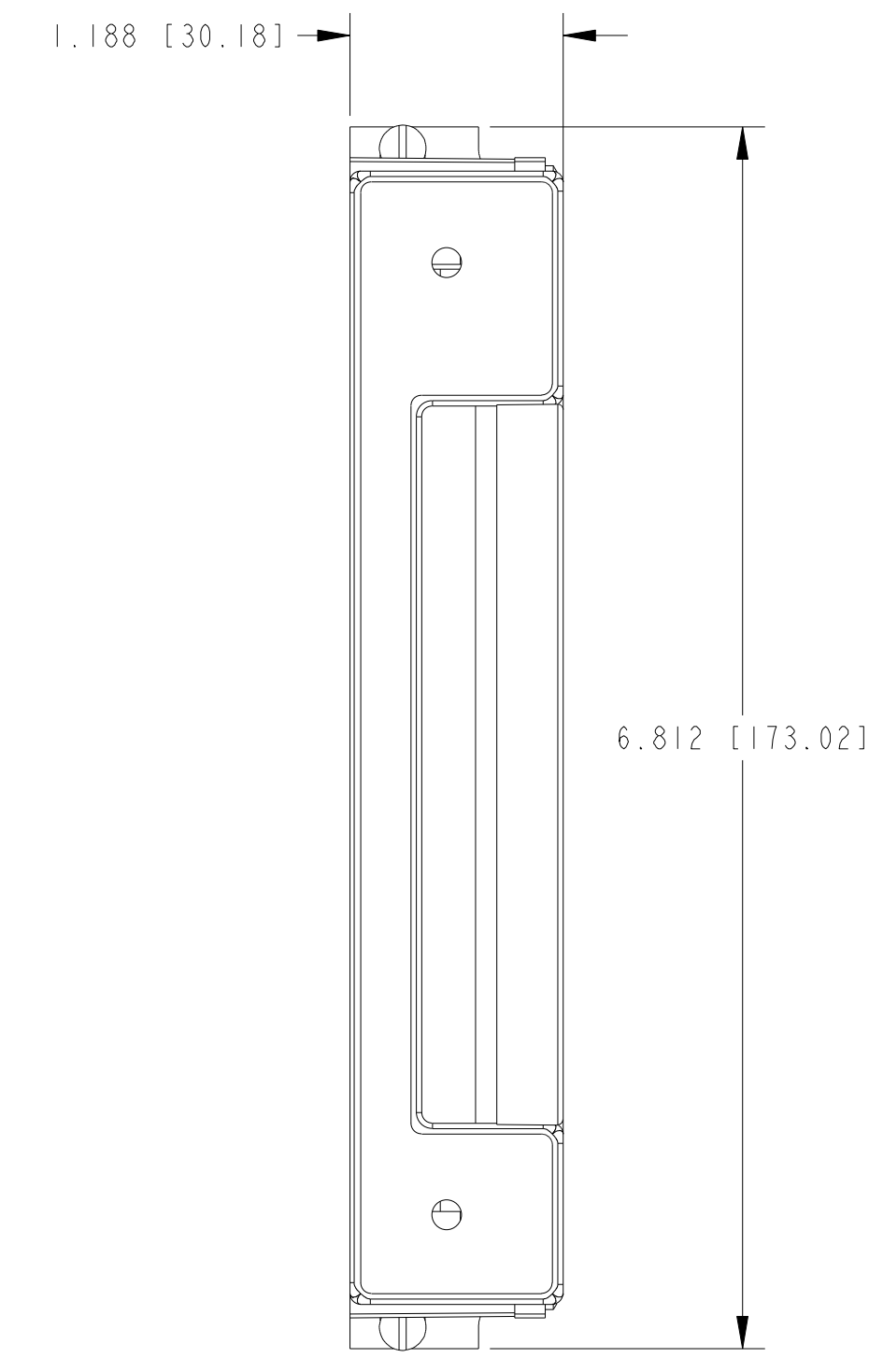
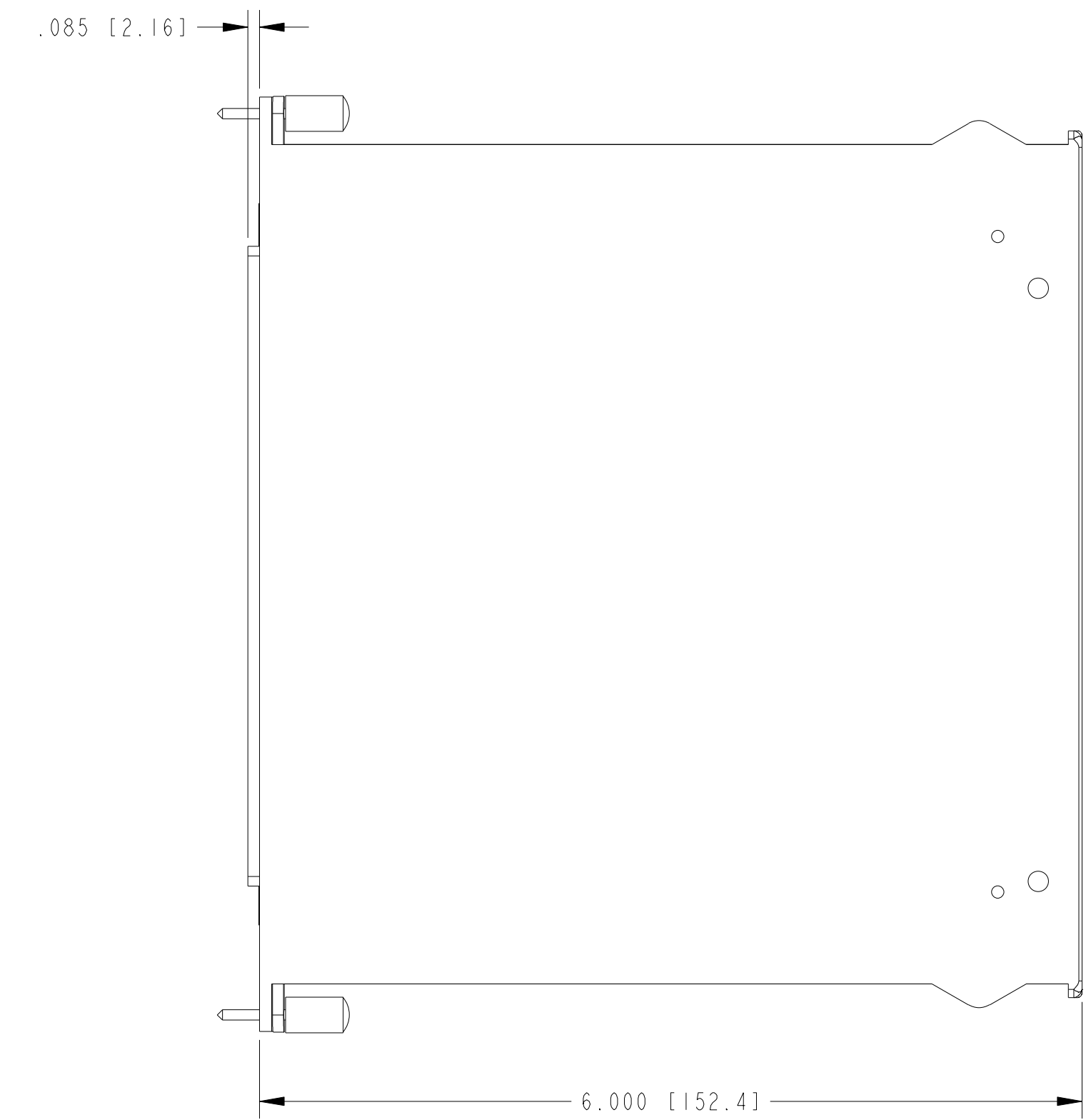
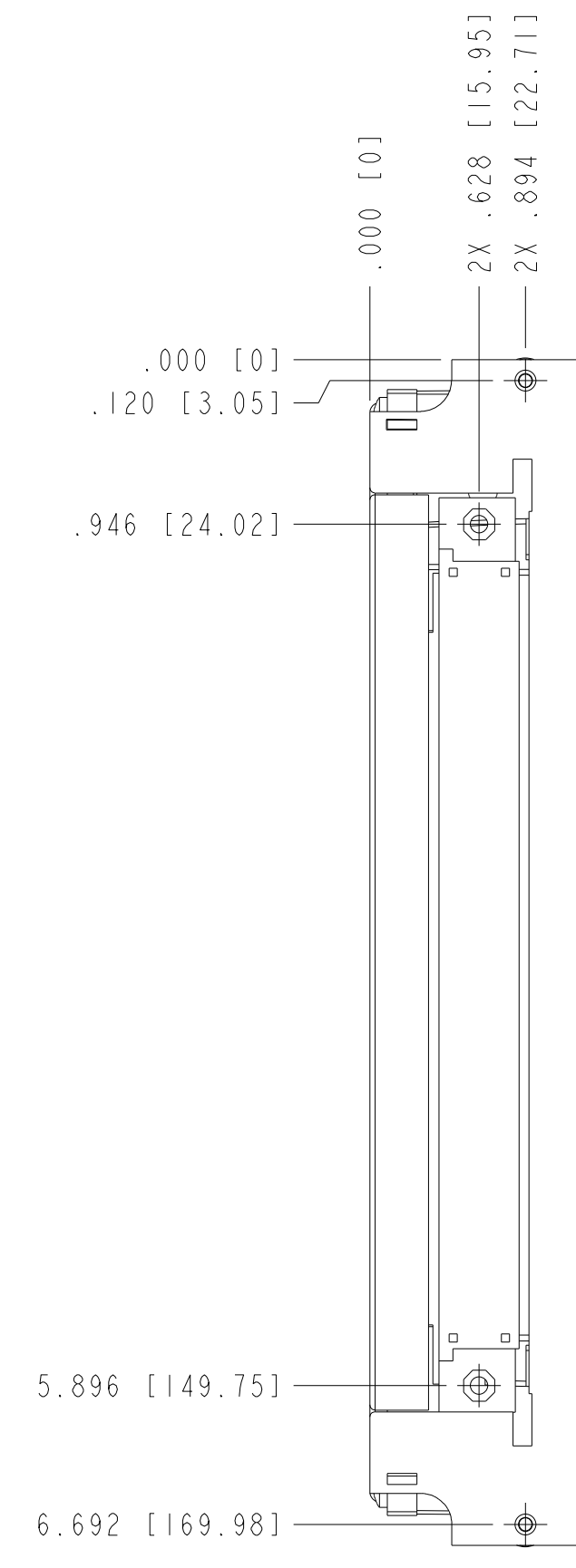

CUSTOMER DRAWING

UNLESS OTHERWISE SPECIFIED
DIMENSIONS ARE IN INCHES AND
[MILLIMETERS].

DO NOT SCALE DRAWING

THIRD ANGLE PROJECTION

NATIONAL INSTRUMENTS® AUSTIN, TEXAS

TITLE

TB-1337

SIZE	CODE	IDENT NO.	MM/DD/YYYY
C	7U296		08/14/2011
SCALE:	1/1	SHEET	OF 1

4

3

2

1