

# GETTING STARTED

# NI SMD-7613/7614/7615/7616 Stepper Motor Drives



**Note** If you are a new user of LabVIEW or are unfamiliar with LabVIEW, refer to the *Getting Started with LabVIEW* manual for information about LabVIEW and LabVIEW terminology.

This document explains how to install and configure the NI SMD-7613/7914/7615/7616 stepper motor drive.

## Contents

---

What You Need to Get Started .....	1
Hardware .....	1
Software .....	2
Related Documentation .....	2
Hardware Installation and Configuration .....	3
Step 1: Connect the Drive to the NI PS-12/13 Power Supply .....	3
Step 2: Connect the SMD to the Motor .....	4
Step 3: Connect the Drive to the Network .....	7
Step 4: Verify the Connections .....	11
Using the SMD with SoftMotion .....	11
Running the Example .....	11
Understanding the Example .....	12
Worldwide Support and Services .....	13

## What You Need to Get Started

---

You need the following items to get started.

### Hardware

- 12 VDC to 80 VDC power supply. NI PS-12 (NI part number 748906-01) or NI PS-13 (NI part number 748907-01) recommended.
- Tool for inserting wires into a screw terminal connector
- A PC running Microsoft Windows 8.1/8/7/Vista/XP SP3, with an available Ethernet port

- A CAT5 Ethernet cable (not included)
- NI SMD-7613/7914/7615/7616 device

## Software

- LabVIEW 2014 or later
- LabVIEW SoftMotion Module 2014 f1 or later
- NI Stepper Configuration Utility, available from [ni.com/downloads](http://ni.com/downloads)



**Note** The following instructions assume all required software is installed. For help installing the required software, refer to the documentation included with that software.

## Related Documentation

The following documents contain additional information that you may find helpful. All referenced documents ship with the product and are available at [ni.com/manuals](http://ni.com/manuals).

- *NI SMD-7613/7614/7615/7616 User Manual*
- *LabVIEW SoftMotion Module Help*—Use this help file to learn about using the NI SoftMotion Module in LabVIEW. To access this help file from LabVIEW, select **Help»LabVIEW Help**, then expand the *LabVIEW NI SoftMotion Module* book on the **Contents** tab.
- *LabVIEW Help*—Use the *LabVIEW Help* to access information about LabVIEW programming concepts, step-by-step instructions for using LabVIEW, and reference information about LabVIEW VIs, functions, palettes, menus, tools, properties, methods, events, dialog boxes, and so on. The *LabVIEW Help* also lists the LabVIEW documentation resources available from National Instruments. Access the *LabVIEW Help* by selecting **Help»LabVIEW Help**.
- *Getting Started with LabVIEW*—Use this document as a tutorial to familiarize yourself with the LabVIEW graphical programming environment and the basic LabVIEW features you use to build data acquisition and instrument control applications. Access the *Getting Started with LabVIEW* PDF by selecting **Start»All Programs»National Instruments»LabVIEW»LabVIEW Manuals»LV\_Getting\_Started.pdf**.

# Hardware Installation and Configuration

This section covers the hardware setup for the NI SMD-7613/7914/7615/7616 device.

## Step 1: Connect the Drive to the NI PS-12/13 Power Supply



**Note** Do not plug in or turn on the power supply until after you complete all of the following steps.

Complete the following steps to connect the power supply to AC input power and to the drive. Figure 1 shows the power supply terminals.

**Figure 1.** NI PS-12/13 Power Supply Terminals

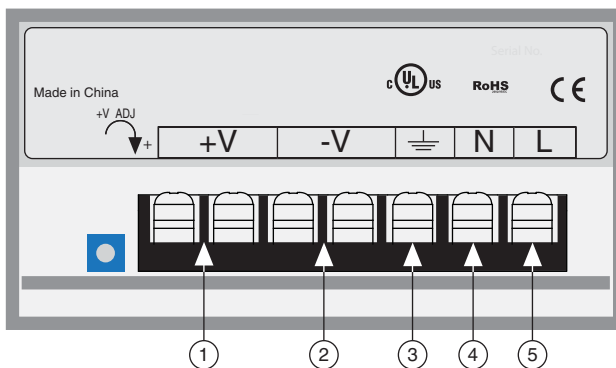

1	+24 V (NI PS-12) or +48 V (NI PS-13) Output	4	AC Input Neutral
2	+24 V (NI PS-12) or +48 V (NI PS-13) Ground	5	AC Input Line
3	AC Input Ground (Protective Earth)		

1. Connect an AC input cable to the line, neutral, and ground (protective earth) connectors.
2. Connect one end of a 1.02 mm to 0.81 mm diameter (18 to 20 AWG) gauge stranded wire to the V+ terminal on the power supply.
3. Connect the free end of the V+ wire to the corresponding terminal on the included power connector. Tighten the screw to ensure a secure connection.
4. Connect one end of a 1.02 mm to 0.81 mm diameter (18 to 20 AWG) gauge stranded wire to the V- terminal on the power supply.
5. Connect the free end of the V- wire to the corresponding terminal on the included power connector. Tighten the screw to ensure a secure connection.
6. Insert the power connector into the stepper motor drive. Tighten the screws to ensure a secure connection.
7. Connect the power supply to AC power. The green Drive Status LED on the SMD should be solid or flashing. For information about blink code meanings, refer to the user manual for your device.

## Step 2: Connect the SMD to the Motor

The drive supports various stepper motors. The connection to the stepper motor depends on the number of leads present. Refer to the following figures to connect your stepper motor.



**Note** Motor wire colors are correct for NI stepper motors compatible with the NI SMD-761x. These wire colors may not match a third-party stepper motor.

### Four Lead Motors

Four lead motors can only be configured according to the following diagram.

**Figure 2.** Four Lead Motor Connection

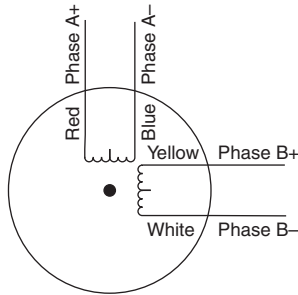

# Six Lead Motors

Six lead motors can be connected in series or center tap.

**Figure 3.** Six Lead Motor Connected in Series

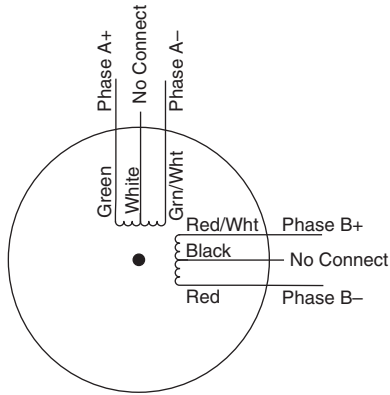

**Figure 4.** Six Lead Motor Connected in Center Tap

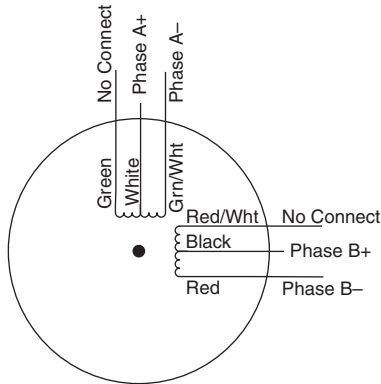

# Eight Lead Motors

Eight lead motors can be connected in series or parallel.

**Figure 5.** Eight Lead Motor Connected in Series

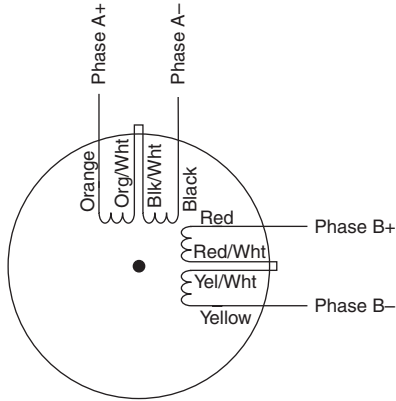

**Figure 6.** Eight Lead Motor Connected in Parallel

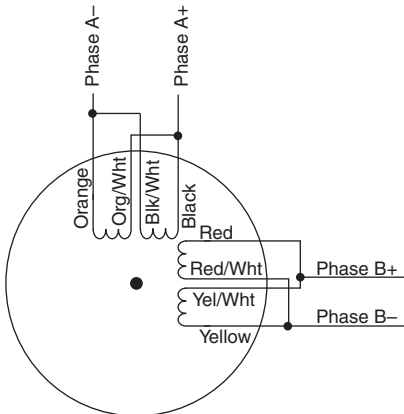

# Step 3: Connect the Drive to the Network

The drive requires only a CAT5 Ethernet cable connection. You can connect the drive directly to your PC's network card, to an auxiliary network card in your PC, or to a router or network switch.

1. Physically connect the device to your network (or directly to the PC).
2. Set the drive IP address.
3. Set the appropriate networking properties on your PC.

Your device includes a 16 position rotary switch for setting its IP address. The factory default address for each switch setting is shown in the table below.

**Table 1. IP Address Rotary Switch Settings**

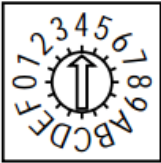
Position	IP Address	
0	10.10.10.10	
1	192.168.1.10	
2	192.168.1.20	
3	192.168.1.30	
4	192.168.0.40	
5	192.168.0.50	
6	192.168.0.60	
7	192.168.0.70	
8	192.168.0.80	
9	192.168.0.90	
A	192.168.0.100	
B	192.168.0.110	
C	192.168.0.120	
D	192.168.0.130	
E	192.168.0.140	
F	DHCP	

The IP address corresponding to positions 1 through E can be changed using the NI Stepper Configuration Utility software. Setting 0 is always 10.10.10.10, the universal recovery address.

Setting F is DHCP, which commands the device to get an IP address from a DHCP server on the network. The IP address automatically assigned by the DHCP server may be dynamic or static

depending on how the administrator has configured DHCP. The DHCP setting is reserved for advanced users.

Your PC, or any other equipment that you use to communicate with the device, will also have a unique address.

On the device switch settings 1 through E use the standard class B subnet mask (i.e., 255.255.0.0). The mask for the universal recovery address is the standard class A (i.e., 255.0.0.0).

## Option 1: Connect a Drive to Your LAN

If you have a spare port on a switch or router and if you are able to set your device to an IP address that is compatible with your network, and not used by anything else, this is a simple way to get connected. This technique also allows you to connect multiple devices to your PC. If you are on a corporate network, check with your system administrator before connecting anything new to the network. He or she should be able assign you a suitable address and help you get going.

**Figure 7. Example Network Configuration**

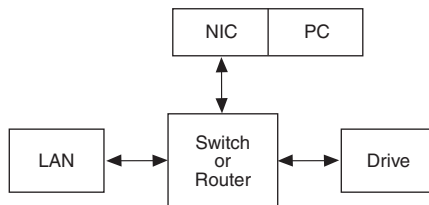

Many networks use dynamic addressing where a DHCP server assigns addresses on demand. The address you choose for your device might get assigned to something else by the DHCP server at another time.

Once you've chosen an appropriate IP address for your device, set the rotary switch according to the address table above. If none of the default addresses are acceptable for your network, you can enter a new table of IP addresses using the NI Stepper Configuration Utility. If your network uses addresses starting with 192 . 168 . 0, the most common subnet, you will want to choose an address from switch settings 4 through E. Another common subnet is 192 . 168 . 1. If your network uses addresses in this range, the compatible default selections are 1, 2 and 3. If your PC address is not in one of the above private subnets, you will have to change your subnet mask to 255 . 255 . 0 . 0 in order to communicate with your device. To change your subnet mask:

1. **Open Network Connections.**
  - a. **(Windows 8.1/8/7/Vista)** Open **Control Panel**. From the icon view, open **Network and Sharing Center**, then click **Change Adapter Settings**.
  - b. **(Windows XP)** Right-click **My Network Places** and select **Properties**.



2. Right-click your network interface card (NIC) and select **Properties**.
  - a. **(Windows 8.1/8/7/Vista)** Scroll down and select **(TCP/IPv4)**, then click **Properties**.
  - b. **(Windows XP)** Scroll down and select **Internet Properties (TCP/IP)**, then click **Properties**.
3. If the **Obtain an IP address automatically** option is selected, your PC is getting an IP address and a subnet mask from the DHCP server. Cancel this dialog and proceed to the *Using DHCP* section.
4. If the option **Use the following IP address** is selected, change the subnet mask to 255.255.0.0 and click **OK**.

## Using DHCP

If you want to use your device on a network where all or most of the devices use dynamic IP addresses supplied by a DHCP server, set the rotary switch to “F”. When the device is connected to the network and powered on, it will obtain an IP address and a subnet mask from the server that is compatible with your PC. However, you will not know what address the server assigns to the device. The NI Stepper Configuration Utility can find your device using the **Drive Discovery** feature, as long as your network isn’t too large. When the device connected to the network is powered on, select **Drive Discovery** from the **Drive** menu to launch the **Network Interface Dialog** dialog box.

**Figure 8.** Network Interface Dialog Box

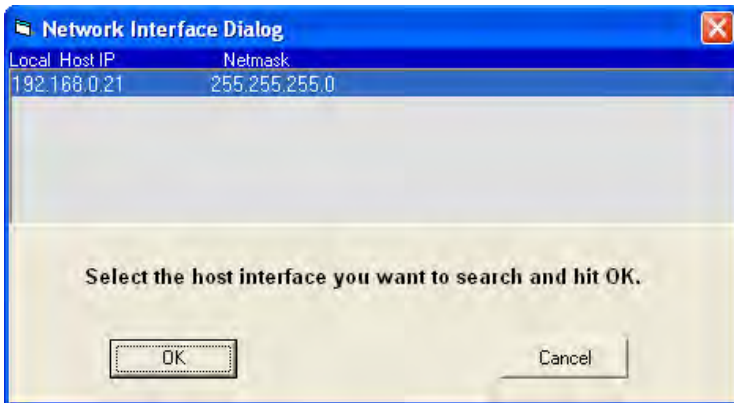

Normally, Drive Discovery only detects one network interface card (NIC), and selects it automatically. If you are using a laptop and have both wireless and wired network connections, a second NIC may appear. Please select the NIC that you use to connect to the network to which you’ve connected your device. Then click **OK**. Drive Discovery notifies you as soon as it has detected a device.

If you think this is the correct device, click **Yes**. If you are not sure, click **Not Sure** and Drive Discovery will look for additional devices on your network. Once you have told Drive Discovery which device is yours, it automatically enters the device IP address in the IP address text box so that you are ready to communicate.

## Option 2: Connect a device Directly to Your PC

1. Connect one end of a CAT5 Ethernet cable into the LAN card (NIC) on your PC and the other into the device. You don't need a special crossover cable; the device automatically detects the direct connection and make the necessary physical layer changes.
2. Set the IP address on the device to 10 . 10 . 10 . 10 by setting the rotary switch to position 0.
3. To set the IP address of your PC:
  - a. **(Windows 8.1/8/7/Vista)** Open **Control Panel**. From the icon view, open **Network and Sharing Center**, then click **Change Adapter Settings**.
  - b. **(Windows XP)** Right-click **My Network Places** and select **Properties**.
4. Right-click your network interface card (NIC) and select **Properties**.
  - a. **(Windows 8.1/8/7/Vista)** Scroll down and select **(TCP/IPv4)**, then click **Properties**.
  - b. **(Windows XP)** Scroll down and select **Internet Properties (TCP/IP)**, then click **Properties**.
5. Select **Use the following IP address** and enter the address 10 . 10 . 10 . 11. This assigns your PC an IP address that is on the same subnet as the device. Windows directs any traffic intended for the device's IP address to this interface card.
6. Next, enter the subnet mask as 255 . 255 . 255 . 0.
7. Leave **Default gateway** blank. This prevents your PC from looking for a router on this subnet.



**Note** Because you are connected directly to the device, anytime the device is not powered you will receive a small message bubble in the corner of your screen saying “The network cable is unplugged.”

## Option 3: Use Two Network Interface Cards (NICs)

This technique allows you to keep your PC connected to your LAN, but keeps the device off the LAN, preventing possible IP conflicts or excessive traffic.

1. If you use a desktop PC and have a spare card slot, install a second NIC and connect it directly to the device using a CAT5 cable. You don't need a special “crossover cable”; the device will automatically detect the direct connection and make the necessary physical layer changes.
2. If you use a laptop and only connect to your LAN using wireless networking, you can use the built-in RJ45 Ethernet connection as your second NIC.
3. Set the IP address on the device to 10 . 10 . 10 . 10 by setting the rotary switch to position 0.
4. To set the IP address of your PC:
  - a. **(Windows 8.1/8/7/Vista)** Open **Control Panel**. From the icon view, open **Network and Sharing Center**, then click **Change Adapter Settings**.
  - b. **(Windows XP)** Right-click **My Network Places** and select **Properties**.

5. Right-click your network interface card (NIC) and select **Properties**.
  - a. **(Windows 8.1/8/7/Vista)** Scroll down and select **(TCP/IPv4)**, then click **Properties**.
  - b. **(Windows XP)** Scroll down and select **Internet Properties (TCP/IP)**, then click **Properties**.
6. Select **Use the following IP address** and enter the address 10.10.10.11. This assigns your PC an IP address that is on the same subnet as the device. Windows directs any traffic intended for the device's IP address to this interface card.
7. Next, enter the subnet mask as 255.255.255.0.
8. Leave **Default gateway** blank. This prevents your PC from looking for a router on this subnet.



**Note** Because you are connected directly to the device, anytime the device is not powered you will receive a small message bubble in the corner of your screen saying “The network cable is unplugged.”

## Step 4: Verify the Connections

Once the drive is powered and connected to the network, and the Status LED does not indicate any errors, you can verify the connection by completing the following steps:

1. Launch NI Stepper Configuration Utility.
2. Locate the drive.
3. Open the **Drive** menu and select **Self Test**.
4. Click **Start**. The motor should begin to move. Click **Stop** to finish the test.

If the motor failed to move, verify the power and network connections. Examine the Status LED and refer to the drive user manual to diagnose any issues.

## Using the SMD with SoftMotion

---

The drive can be used in a LabVIEW VI as a standard motion resource. To easily see the best way to use the SMD in a VI, refer to the Axis Straight Line Move- Ethernet Stepper example. To load the example VI included with SoftMotion 2014, navigate to <labview>\examples\motion\Property Nodes\Axis Straight Line Move and launch **Axis Straight Line Move - Ethernet Stepper**.

## Running the Example

The example allows you to perform an Axis Straight Line Move using the SMD. To begin, open the example front panel and configure the applicable parameters in the Move Constraints control. The default values should be acceptable for the purposes of the example.

- **Move Mode**— Select the type of Axis Straight-Line Move to perform. Options are Absolute, Relative, and Velocity. For information about the different kinds of moves, refer to the SoftMotion Help.
- **Axis**— Enter the IP address of the drive. For example, a device using the universal recovery address would be entered as `niss:\\10.10.10.10`.

- **Position**— Specify the target position, in the axis will be driven toward.
- **Velocity**— Specific the maximum velocity of the move in steps/s.
- **Acceleration**— Specify the maximum rate of acceleration when starting the move, in Units/s<sup>2</sup>.
- **Deceleration**— Specify the maximum rate of deceleration when stopping the move, in Units/s<sup>2</sup>.

When all the settings are configured, run the VI, and click the **Start Move** button. The motor should turn according to the configured move. Click the **Stop Move** button to stop the motor, and the **Stop VI** when you are finished with the project.

## Understanding the Example

The example VI begins by creating a motion resource and using an invoke node to enable the drive.

**Figure 9.** Creating a Motion Resource

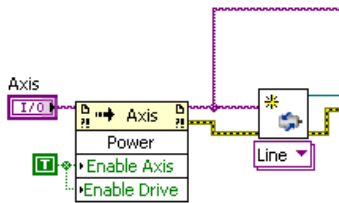

When the move is started, all of the configured parameters are written with a property node. The position feedback is read with an invoke node and displayed.

**Figure 10.** Applying the Move Parameters

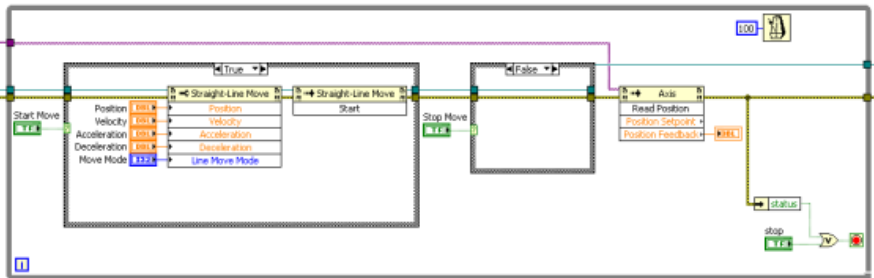

After the move has been stopped, errors are cleared and the motion reference is destroyed.

**Figure 11. Destroying Move Reference**

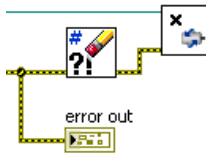

## Worldwide Support and Services

The National Instruments website is your complete resource for technical support. At [ni.com/support](http://ni.com/support) you have access to everything from troubleshooting and application development self-help resources to email and phone assistance from NI Application Engineers.

Visit [ni.com/services](http://ni.com/services) for NI Factory Installation Services, repairs, extended warranty, and other services.

Visit [ni.com/register](http://ni.com/register) to register your National Instruments product. Product registration facilitates technical support and ensures that you receive important information updates from NI.

A Declaration of Conformity (DoC) is our claim of compliance with the Council of the European Communities using the manufacturer's declaration of conformity. This system affords the user protection for electromagnetic compatibility (EMC) and product safety. You can obtain the DoC for your product by visiting [ni.com/certification](http://ni.com/certification). If your product supports calibration, you can obtain the calibration certificate for your product at [ni.com/calibration](http://ni.com/calibration).

National Instruments corporate headquarters is located at 11500 North Mopac Expressway, Austin, Texas, 78759-3504. National Instruments also has offices located around the world. For telephone support in the United States, create your service request at [ni.com/support](http://ni.com/support) or dial 1 866 ASK MYNI (275 6964). For telephone support outside the United States, visit the Worldwide Offices section of [ni.com/niglobal](http://ni.com/niglobal) to access the branch office websites, which provide up-to-date contact information, support phone numbers, email addresses, and current events.

Refer to the *NI Trademarks and Logo Guidelines* at [ni.com/trademarks](http://ni.com/trademarks) for more information on National Instruments trademarks. Other product and company names mentioned herein are trademarks or trade names of their respective companies. For patents covering National Instruments products/technology, refer to the appropriate location: **Help»Patents** in your software, the `patents.txt` file on your media, or the *National Instruments Patents Notice* at [ni.com/patents](http://ni.com/patents). You can find information about end-user license agreements (EULAs) and third-party legal notices in the readme file for your NI product. Refer to the *Export Compliance Information* at [ni.com/legal/export-compliance](http://ni.com/legal/export-compliance) for the National Instruments global trade compliance policy and how to obtain relevant HTS codes, ECCNs, and other import/export data. NI MAKES NO EXPRESS OR IMPLIED WARRANTIES AS TO THE ACCURACY OF THE INFORMATION CONTAINED HEREIN AND SHALL NOT BE LIABLE FOR ANY ERRORS. U.S. Government Customers: The data contained in this manual was developed at private expense and is subject to the applicable limited rights and restricted data rights as set forth in FAR 52.227-14, DFAR 252.227-7014, and DFAR 252.227-7015.

© 2014 National Instruments. All rights reserved.