

## USER GUIDE

# NI USB-5132/5133 OEM

## USB Digitizers

This document provides dimensions and information about the connectors, LEDs, and chassis ground of the National Instruments USB-5132/5133 OEM devices. It also explains how to modify the USB device name in Microsoft Windows.



**Caution** There are no product safety, electromagnetic compatibility (EMC), or CE marking compliance claims made for the USB-5132/5133 OEM devices. Conformity to any and all compliance requirements rests with the end product supplier.



**Caution** Exercise caution when placing USB-5132/5133 OEM devices inside an enclosure. Auxiliary cooling may be necessary to keep the device under the maximum ambient temperature rating of 55 °C, as specified in the *NI 5132/5133 Specifications*.

Figure 1 shows the USB-5132/5133 OEM device.

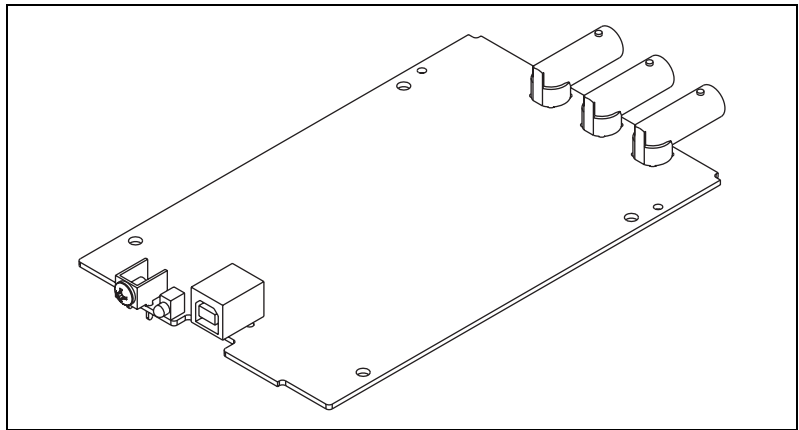

**Figure 1.** USB-5132/5133 OEM Device

Refer to the *NI 5132/5133 Specifications* document for device specifications. Refer to the *NI High-Speed Digitizers Help* for more

information about USB-5132/5133 devices. You can find all documentation at [ni.com/manuals](http://ni.com/manuals).

# Dimensions

Figure 2 shows the dimensions of the USB-5132/5133 OEM device.

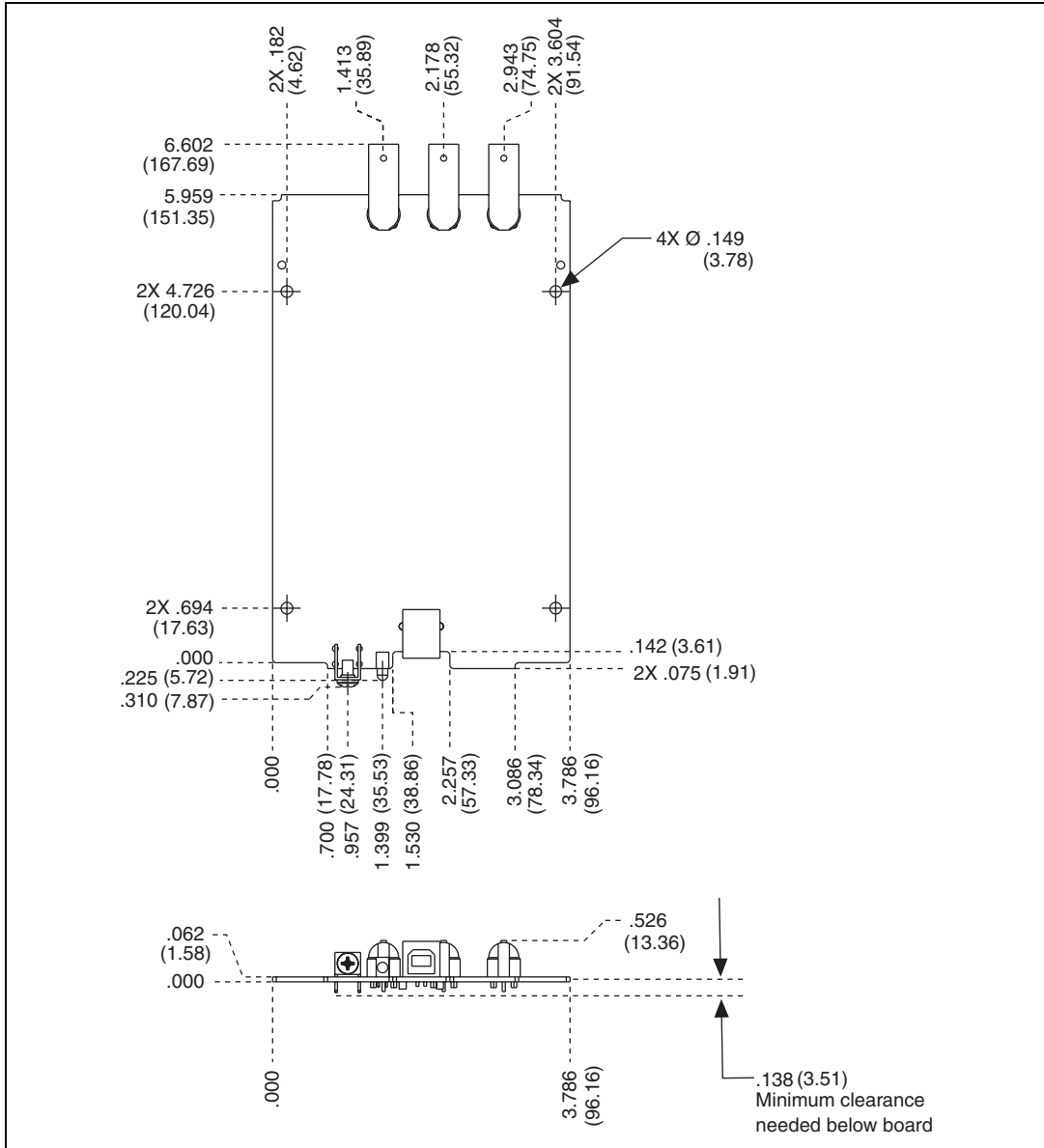

**Figure 2.** USB-5132/5133 OEM Dimensions in Inches (millimeters)

# Connecting the USB-5132/5133 OEM Device to Your Chassis

The USB-5132/5133 OEM device includes several plated mounting holes that are designed for customer grounded connections, as shown in Figure 3.



**Caution** Do not use the holes labeled A in Figure 3 as mounting holes.

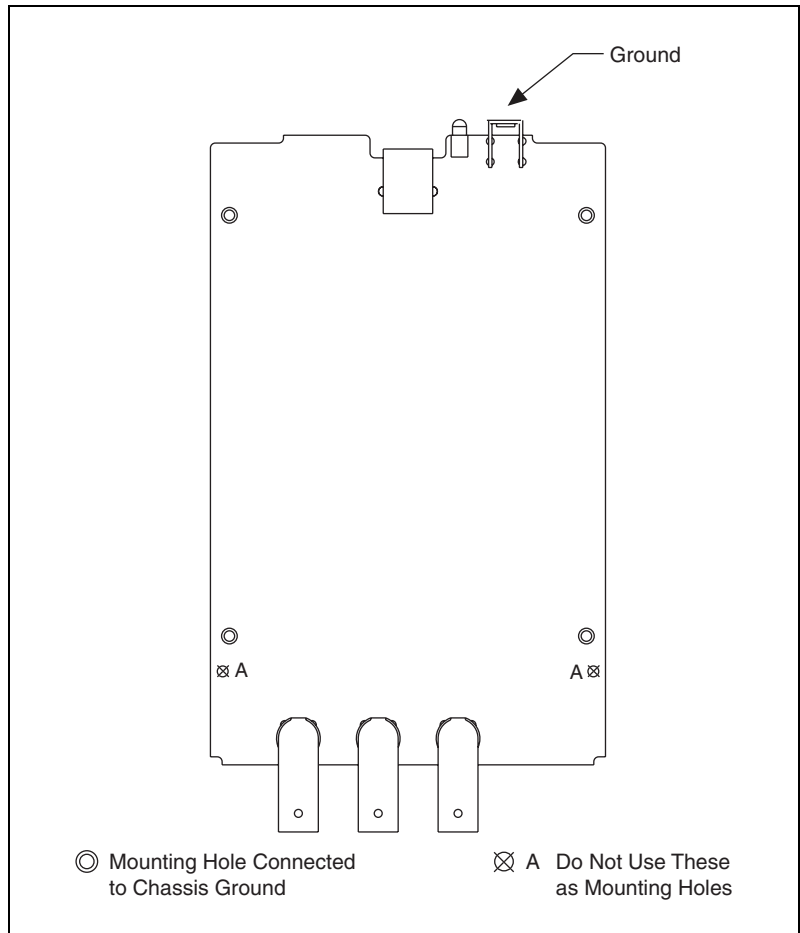

**Figure 3.** USB-5132/5133 OEM Customer Mounting Holes

# Device Components

Table 1 contains information about the components used for interfacing and interacting with the USB-5132/5133 OEM device.

**Table 1.** USB-5132/5133 OEM Components

Component	Reference Designator(s) on PCB	Manufacturer	Manufacturer Part Number
LEDs	DS1	Sunled	XVQ1LUG41D
USB connector	J4	AMP	292304-1
BNC	J1, J3, J5	AMP	5413631-1

## Modifying the USB Device Name in Microsoft Windows

You can change how the USB-5132/5133 OEM device name appears when users install the device in both the Found New Hardware Wizard that appears when the device is initially installed and in the Windows Device Manager.

### Windows Vista/XP Users

Figure 4 depicts how a USB-5133 OEM device name appears in the Found New Hardware Wizard and Windows Device Manager.

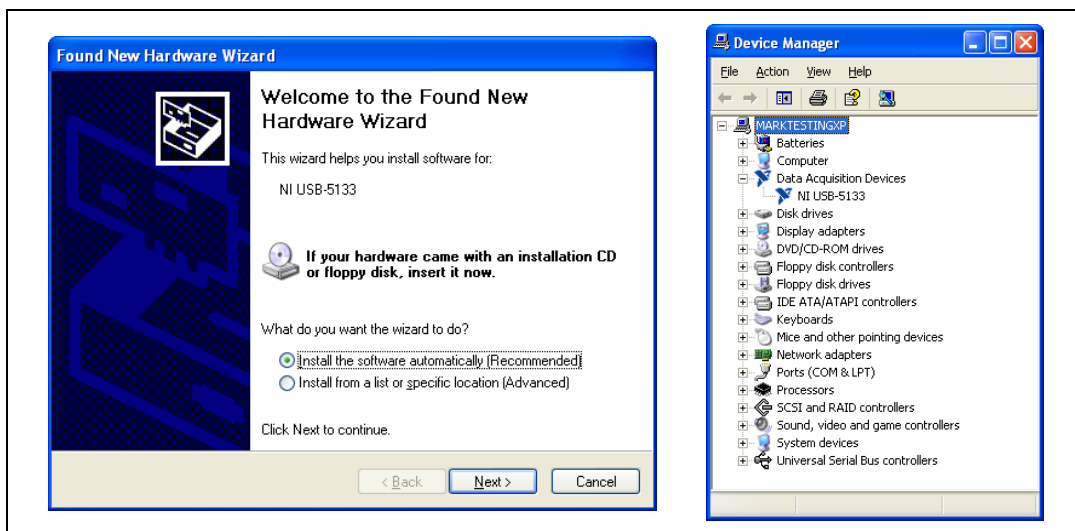

**Figure 4.** USB-5133 OEM Device in the Found New Hardware Wizard and Device Manager (Windows Vista/XP)

To modify the device name in the Found New Hardware Wizard and Windows Device Manager in Microsoft Windows Vista/XP, complete the following steps.



**Note** You *must* have NI-SCOPE 3.4 or later installed on your PC.

1. Locate the NIHSD2k.inf file in the y:\WINDOWS\inf\ directory, where y:\ is the root directory where Windows is installed.  
If you want to revert back, save a copy of this file as NIHSD2k\_original.inf in a different location.
2. Edit the device INF file by opening NIHSD2k.inf with a text editor.  
At the bottom of this file are the descriptors where Windows looks to identify the device. Locate the four lines of text that contain in quotes the descriptors for the device name you are modifying. Change the descriptor on *all* lines to the new device name, as shown in Figure 5.

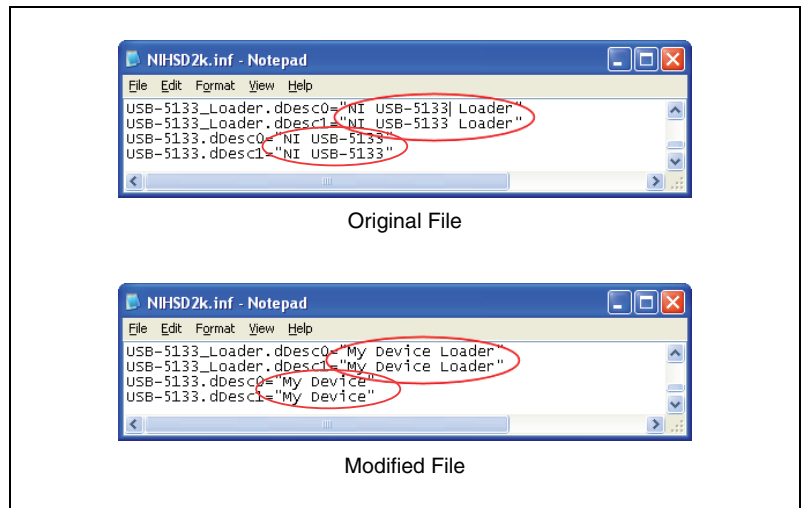

**Figure 5.** INF File Descriptors Changed to “My Device” (Windows Vista/XP)

3. Save and close the INF file.
4. Go to the Windows Device Manager.  
**(Windows Vista)** In the Device Manager, notice that the OEM device now appears as My Device, as shown in Figure 6.  
**(Windows XP)** In the Device Manager, right-click the OEM device under Data Acquisition Devices, and select **Uninstall**. Power down the OEM device and disconnect the USB cable from your PC.

When you reconnect and power on the device, it appears as *My Device* in the Found New Hardware Wizard and Windows Device Manager, as shown in Figure 6.



**Note** When the device is initially installed, the Windows alert message may display the following: **Found New Hardware: USB 513x**. This message appears for a few seconds until the custom name appears and the Found New Hardware Wizard is launched. This alert message device name cannot be changed.

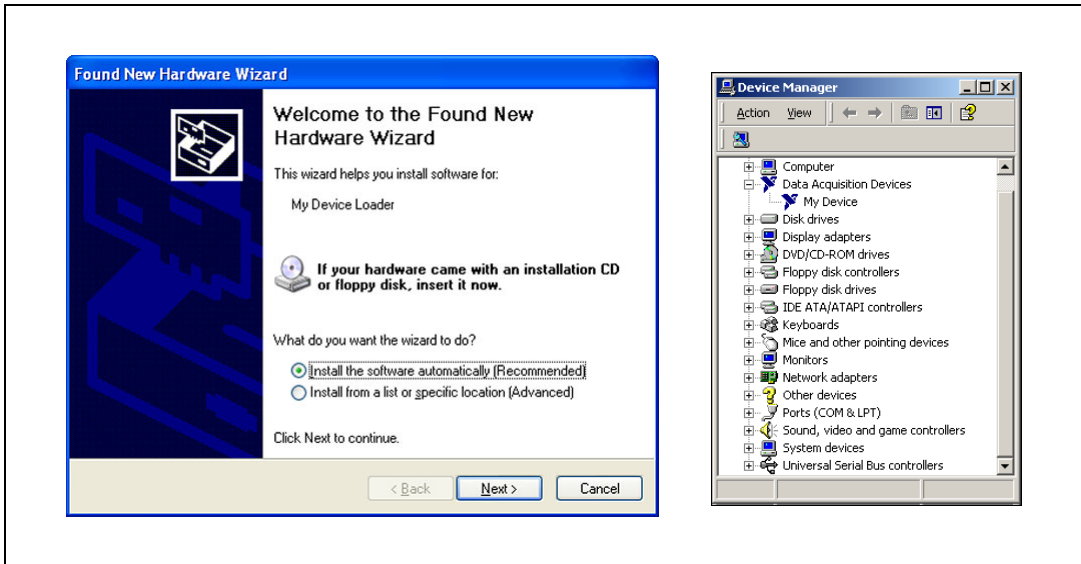

**Figure 6.** “My Device” in the Found New Hardware Wizard and Device Manager (Windows Vista/XP)



**Note** Modifying the INF file will *not* change the USB-5132/5133 OEM device name in Measurement & Automation Explorer (MAX).

# Windows 2000 Users

Figure 7 depicts how a USB-5133 OEM device name appears in the Found New Hardware Wizard and Windows Device Manager.

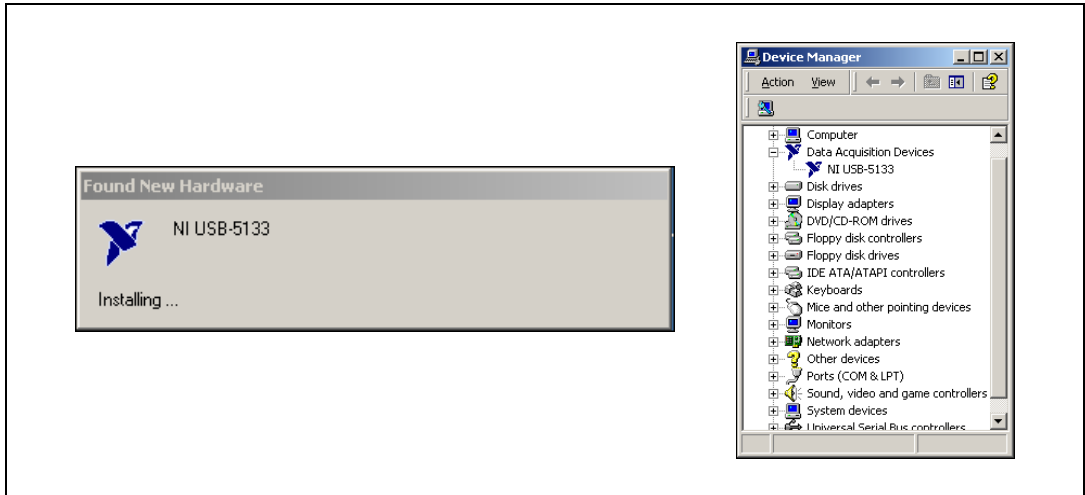

**Figure 7.** USB-5133 OEM Device in the Found New Hardware Wizard and Device Manager (Windows 2000)

To modify the device name in the Found New Hardware Wizard and Windows Device Manager in Windows 2000, complete the following steps.



**Note** You *must* have NI-SCOPE 3.4 or later installed on your PC.

1. Locate the `NIHSD2k.inf` file in the `x:\WINNT\inf\` directory, where `x:\` is the root directory where Windows is installed.

If you want to revert back, save a copy of this file as `NIHSD2k_original.inf` in a different location.

2. Edit the device INF file by opening `NIHSD2k.inf` with a text editor. At the bottom of this file are the descriptors where Windows looks to identify the device. Locate the four lines of text that contain in quotes the descriptors for the device name you are modifying. Change the descriptor on *all* lines to the new device name, as shown in Figure 8.

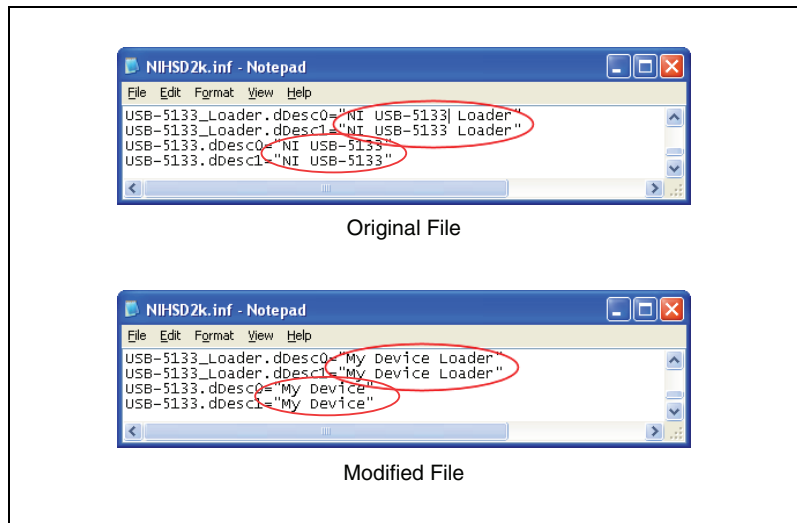

**Figure 8.** INF File Descriptors Changed to “My Device” (Windows 2000)

3. Save and close the INF file.
4. Go to the Windows Device Manager, right-click the OEM device under Data Acquisition Devices, and select **Uninstall**.
5. Power down the OEM device and disconnect the USB cable from your PC.



When you reconnect and power on the device, it appears as **My Device** in the Found New Hardware Wizard and Windows Device Manager, as shown in Figure 9.



**Note** When the device is initially installed, the Windows alert message may display the following: **Found New Hardware: USB 513x**. This message appears for a few seconds until the custom name appears and the Found New Hardware Wizard is launched. This alert message device name cannot be changed.

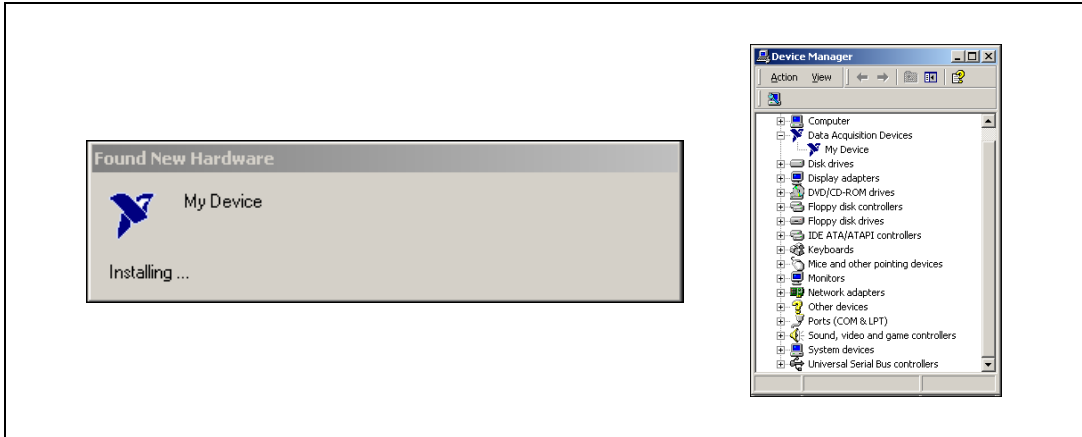

**Figure 9.** “My Device” in the Found New Hardware Wizard and Device Manager (Windows 2000)



**Note** Modifying the INF file will *not* change the USB-5132/5133 OEM device name in Measurement & Automation Explorer (MAX).

National Instruments, NI, ni.com, and LabVIEW are trademarks of National Instruments Corporation. Refer to the *Terms of Use* section on [ni.com/legal](http://ni.com/legal) for more information about National Instruments trademarks. Other product and company names mentioned herein are trademarks or trade names of their respective companies. For patents covering National Instruments products/technology, refer to the appropriate location: **Help»Patents** in your software, the `patents.txt` file on your media, or the *National Instruments Patent Notice* at [ni.com/patents](http://ni.com/patents).