

INSTALLATION GUIDE

FOUNDATION™ Fieldbus Hardware and NI-FBUS™ Software for Windows

This guide contains installation and configuration instructions for the PCI-FBUS, PCMCIA-FBUS, USB-8486, and the FBUS-HSE/H1 linking device on Windows.



Notes Install the NI-FBUS software before you install the hardware.

Contents

Installing the Software	1
Installing the Hardware	2
Install Your PCI-FBUS Card	2
Install Your PCMCIA-FBUS Card	3
Install Your USB-8486	5
Install Your FBUS-HSE/H1 LD	7

Installing the Software

Complete the following steps to install the NI-FBUS software.



Caution If you are reinstalling the NI-FBUS software over a previous version, write down your card configuration and any port configuration parameters you changed from their defaults. Reinstalling the software may cause you to lose any existing card and port configuration information.

1. Log in as `Administrator` or as a user that has Administrator privileges.
2. Insert the *NI-FBUS Software for Windows* CD into the CD-ROM drive.
If the installer does not launch automatically, navigate to the CD using Windows Explorer and launch the `autorun.exe` file from the CD.

3. The interactive setup program guides you through the necessary steps to install the NI-FBUS software. You may go back and change values where appropriate by clicking **Back**. You can exit the setup where appropriate by clicking **Cancel**.
4. Power down your computer when the setup is complete.
5. Continue to the *Installing the Hardware* section to configure and install your hardware.

Installing the Hardware

This section describes how to install your PCI-FBUS, PCMCIA-FBUS, USB-8486, and FBUS-HSE/H1 linking device.



Note Here, the term *PCI-FBUS* represents PCI-FBUS/2; the term *PCMCIA-FBUS* represents PCMCIA-FBUS, PCMCIA-FBUS/2, PCMCIA-FBUS Series 2, and PCMCIA-FBUS/2 Series 2.

Install Your PCI-FBUS Card



Caution Before you remove the card from the package, touch the antistatic plastic package to a metal part of the system chassis to discharge electrostatic energy, which can damage several components on the PCI-FBUS card.

To install the PCI-FBUS card, complete the following steps.

1. Shut down and power off the computer. Keep the computer plugged in so that it remains grounded while you install the PCI-FBUS card.
2. Remove the top cover or access port of the I/O channel.
3. Remove the expansion slot cover on the back panel of the computer.
4. As shown in Figure 1, insert the PCI-FBUS card into any unused PCI slot with the Fieldbus connector protruding from the opening on the back panel. Make sure all pins are inserted an equal depth into the connector. Although it might be a tight fit, do *not* force the card into place.

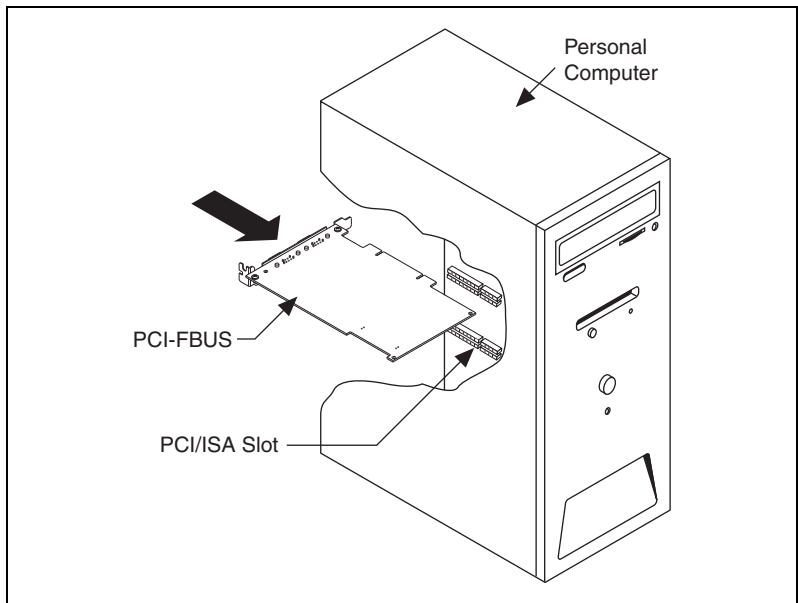

Figure 1. Installing the PCI-FBUS Card

5. Screw the mounting bracket of the PCI-FBUS card to the back panel rail of the computer.
6. Keep the top cover or access port off until you have verified that the hardware resources do not conflict.
7. Power on the computer.
8. Launch the Interface Configuration Utility. Find the PCI-FBUS card and right-click to enable.
9. Close the Interface Configuration Utility and start the NI-FBUS Communications Manager or NI-FBUS Configurator.

Install Your PCMCIA-FBUS Card



Caution Before you remove the card from the package, touch the antistatic plastic package to a metal part of the system chassis to discharge electrostatic energy, which can damage several components on the PCMCIA-FBUS card.

To install the PCMCIA-FBUS card, complete the following steps.

1. Power on the computer and allow the operating system to boot.
2. Insert the card into a free PCMCIA (or Cardbus) socket. The card has no jumpers or switches to set. Figure 2 shows how to insert the PCMCIA-FBUS and how to connect the PCMCIA-FBUS cable and connector to the PCMCIA-FBUS card. However, the

PCMCIA-FBUS/2 cable has two connectors. Refer to Chapter 3, *Connector and Cabling*, of the *NI-FBUS Hardware and Software User Manual*, for more information about these two connectors.

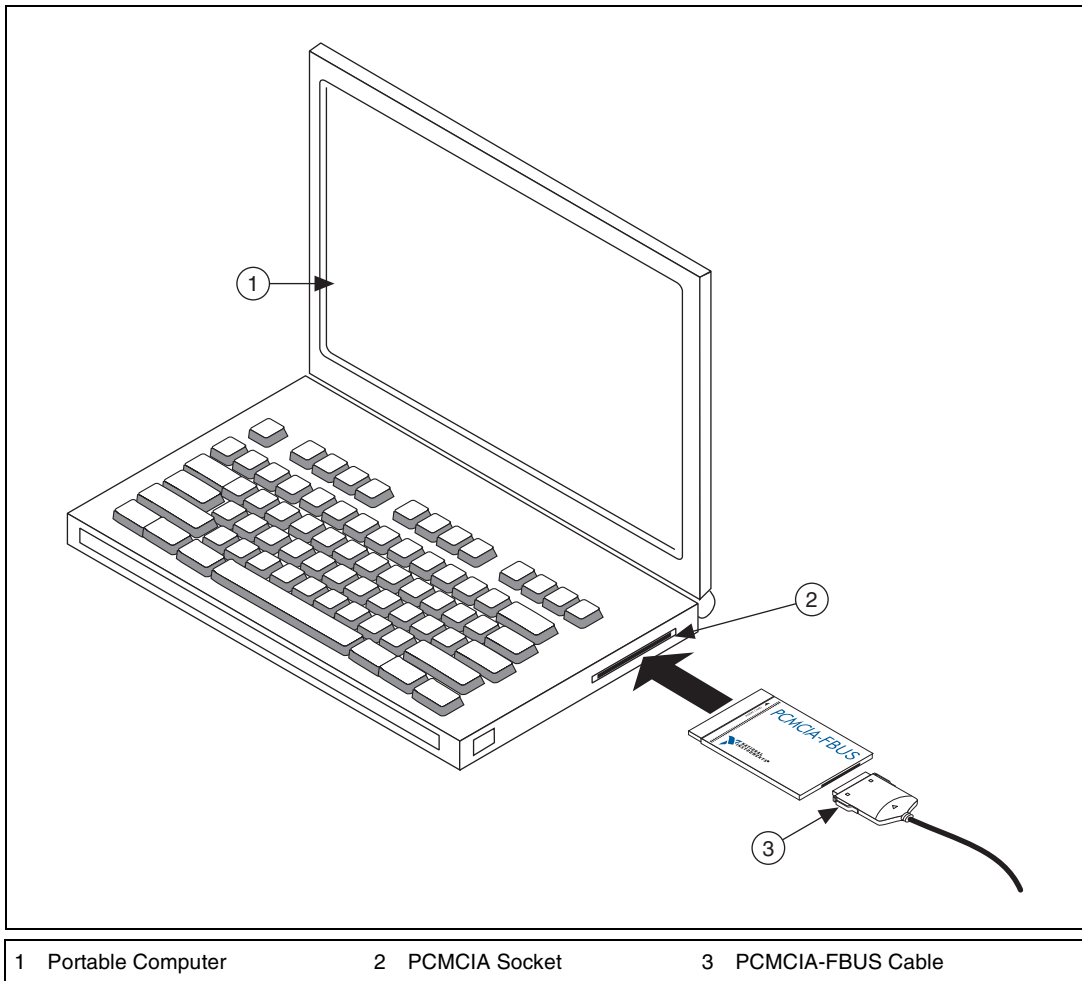

Figure 2. Inserting the PCMCIA-FBUS Card

3. Connect the PCMCIA-FBUS to the Fieldbus network.
Your kit contains a PCMCIA-FBUS cable. Refer to Chapter 3, *Connector and Cabling*, of the *NI-FBUS Hardware and Software User Manual*, if you need a longer cable than the PCMCIA-FBUS cable provided.

Install Your USB-8486



Caution Operate the USB-8486 only as described in the operating instructions. Do *not* unplug the USB-8486 when the NI-FBUS software is running.

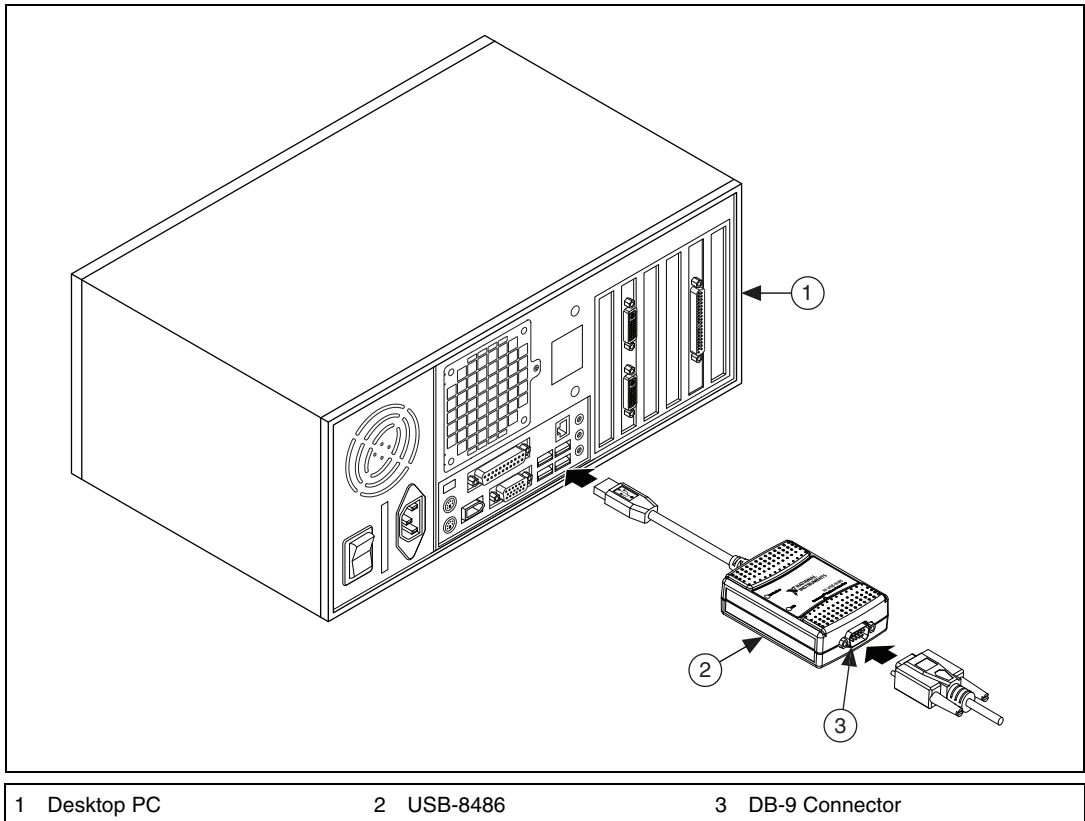

Figure 3. Connecting the USB-8486 to a Desktop PC

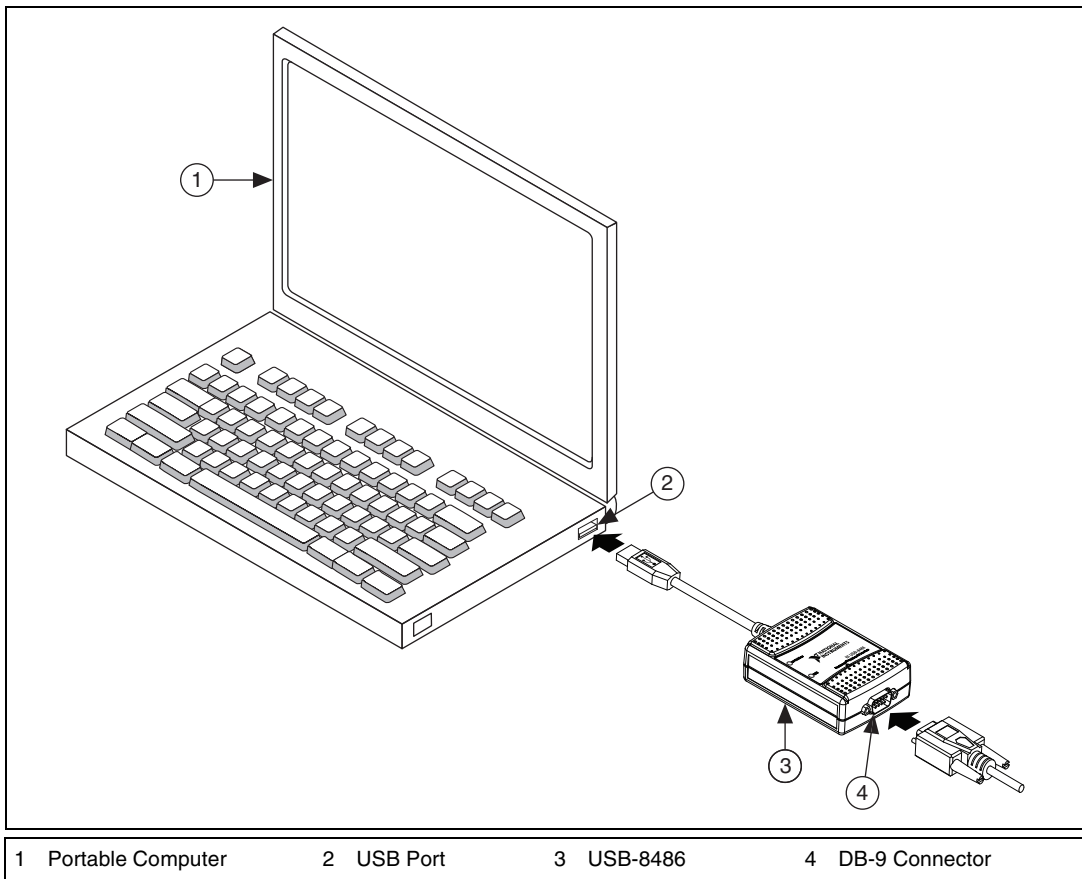

Figure 4. Inserting the USB-8486

To install the USB-8486, complete the following steps.

1. Power on the computer and allow the operating system to boot.
2. Insert the USB-8486 into a free USB port, as shown in Figure 3 and Figure 4.
3. Connect the USB-8486 to the Fieldbus network. Refer to the *NI-FBUS Hardware and Software User Manual* for more information about the connectors.
4. Launch the Interface Configuration Utility.
5. Right-click the USB-8486 to enable if it is disabled.
6. Close the Interface Configuration Utility and start the NI-FBUS Communications Manager or NI-FBUS Configurator.

Install Your FBUS-HSE/H1 LD

The FBUS-HSE/H1 LD has a simple rail clip for reliable mounting onto a standard 35 mm DIN rail.

To install the FBUS-HSE/H1 LD, complete the following steps.

1. Use a flathead screwdriver to open the DIN rail clip to the unlocked position, as shown in Figure 5.

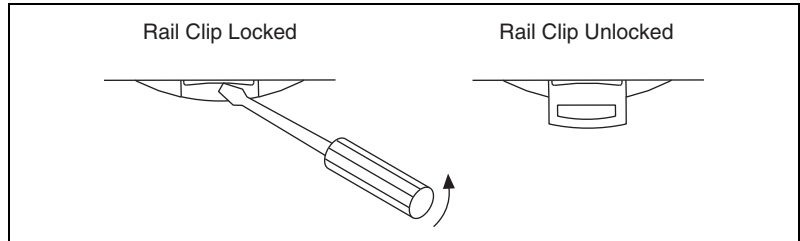

Figure 5. DIN Rail Clip

2. Hook the lip on the rear of the FBUS-HSE/H1 LD onto the top of a 35 mm DIN rail and press the FBUS-HSE/H1 LD down onto the DIN rail, as shown in Figure 6.

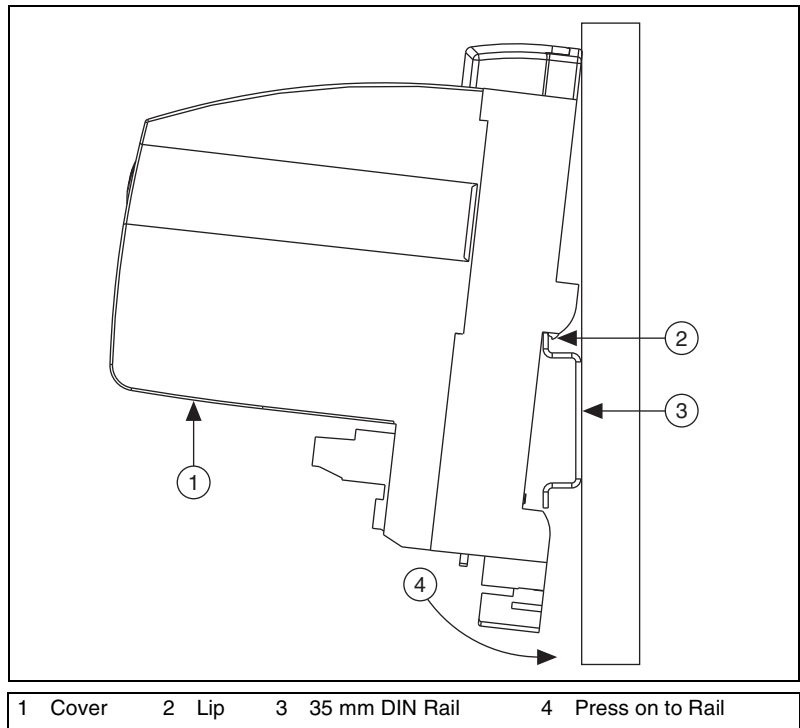

Figure 6. Mounting the FBUS-HSE/H1 LD on a DIN Rail

3. Slide the FBUS-HSE/H1 LD to the desired position along the DIN rail. After the FBUS-HSE/H1 LD is in position, lock it to the DIN rail by pushing the rail clip to the locked position, as shown in Figure 5.
4. Connect the RJ-45 Ethernet port of the FBUS-HSE/H1 LD to an Ethernet hub using a standard Category 5 Ethernet cable.



Note Do *not* use a cable longer than 100 m. If you are using a 10 Mbps Ethernet, National Instruments recommends using a Category 5 shielded twisted-pair Ethernet cable.

5. Figure 7 shows the power, H1, and Ethernet connectors on the FBUS-HSE/H1 LD.

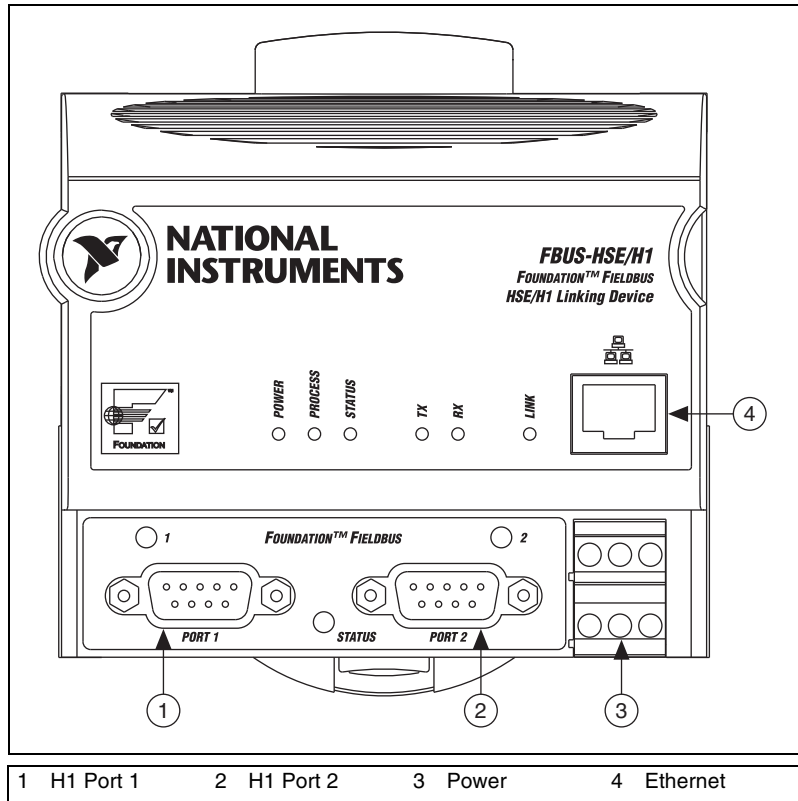

Figure 7. Connectors on the FBUS-HSE/H1 LD

6. Use the Fieldbus cable with 9-pin female D-sub connector to connect the H1 ports of FBUS-HSE/H1 LD to a Fieldbus network.

7. Connect the primary 11–30 VDC power supply to the center V and C pair with the positive and negative wires on your power cable in the V and C terminals, respectively. You can connect an optional backup power supply to the left V and C pair. The power connector is a 6-pin screw terminal power connector whose pinout is shown in Figure 8.

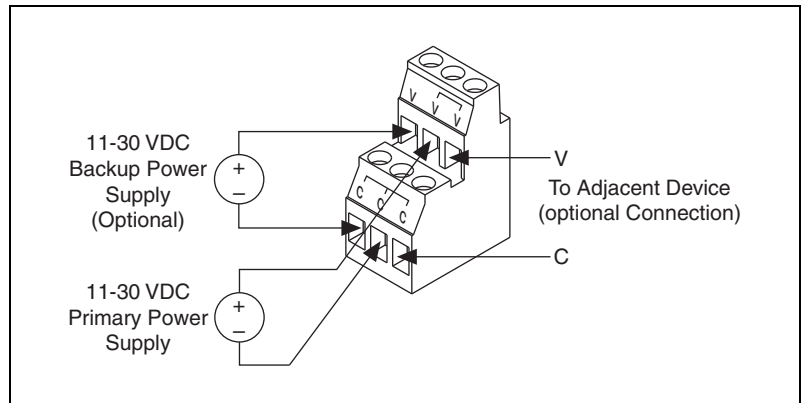

Figure 8. FBUS-HSE/H1 Power Connector Pinout

8. Power on your FBUS-HSE/H1 LD. At power-up, the FBUS-HSE/H1 LD runs a set of power-on self tests (POST) that take several seconds, and the green **POWER** LED is lit. For more information about reading the POST status, refer to the *LED Indicators* section of Appendix B, *Troubleshooting and Common Questions*, of the *NI-FBUS Hardware and Software User Manual*.



Note If you are using the third-party HSE/H1 linking device, refer to the related user manual or reference materials to install the hardware.

LabVIEW, National Instruments, NI, ni.com, the National Instruments corporate logo, and the Eagle logo are trademarks of National Instruments Corporation. Refer to the *Trademark Information* at ni.com/trademarks for other National Instruments trademarks. Other product and company names mentioned herein are trademarks or trade names of their respective companies. For patents covering National Instruments products/technology, refer to the appropriate location: **Help»Patents** in your software, the `patents.txt` file on your media, or the *National Instruments Patent Notice* at ni.com/patents.