

USER GUIDE

NI-IMAQ™ for USB Cameras

The NI-IMAQ for USB Cameras User Guide contains information you need to get started with NI-IMAQ for USB Cameras.

This guide presents the basics of image acquisition, provides an overview of the software, and briefly describes application development with NI-IMAQ for USB Cameras.

Contents

Contents	1
Conventions	1
About NI-IMAQ for USB Cameras	2
Application Development Environments.....	2
Building Applications with NI-IMAQ for USB Cameras	3
Architecture	3
NI-IMAQ for USB Cameras VI Location	3
Example Programs	5
Buffer Management	5
Acquisition Types	6
Snap	6
Grab	6
NI-IMAQ for USB Cameras and NI Vision Assistant.....	7
Error Codes	9

Conventions

The following conventions are used in this manual:

»

The » symbol leads you through nested menu items and dialog box options to a final action. The sequence **File»Page Setup»Options** directs you to pull down the **File** menu, select the **Page Setup** item, and select **Options** from the last dialog box.



This icon denotes a note, which alerts you to important information.

bold	Bold text denotes items that you must select or click in the software, such as menu items and dialog box options. Bold text also denotes parameter names.
<i>italic</i>	Italic text denotes variables, emphasis, a cross reference, or an introduction to a key concept. This font also denotes text that is a placeholder for a word or value that you must supply.
monospace	Text in this font denotes text or characters that you should enter from the keyboard, sections of code, programming examples, and syntax examples. This font is also used for the proper names of disk drives, paths, directories, programs, subprograms, subroutines, device names, functions, operations, variables, filenames, and extensions.

About NI-IMAQ for USB Cameras

NI-IMAQ for USB Cameras provides the ability to use USB cameras that have Direct Show Filters with the NI Vision Assistant or LabVIEW and IMAQ Vision. The cameras may operate at various resolutions and frame rates, depending on camera capabilities. NI-IMAQ for USB Cameras can acquire and set properties using the camera manufacturer driver and Direct Show functions. For NI-IMAQ for USB Cameras to use the camera successfully, the camera manufacturer driver needs to be correctly installed and recognized by the operating system. Refer to your camera documentation for instructions about how to correctly install the manufacturer driver.

Application Development Environments

NI-IMAQ for USB Cameras supports the following application development environments for Windows 2000/XP:

- LabVIEW 7.0 or later with IMAQ Vision 7.1 or later
- Vision Assistant 7.1 or later

Building Applications with NI-IMAQ for USB Cameras

The NI-IMAQ for USB Cameras Virtual Instrument (VI) Library is a series of LabVIEW VIs for using LabVIEW with your USB camera and is included with the NI-IMAQ for USB Cameras software.

IMAQ Vision for LabVIEW is an image processing and analysis library consisting of more than 400 VIs. IMAQ Vision for LabVIEW is required to use the NI-IMAQ for USB Cameras VI library.

The following sections describe the basic concepts and information necessary to build an application with NI-IMAQ for USB Cameras.

Architecture

Figure 1 shows a block diagram of the NI-IMAQ for USB Cameras architecture.

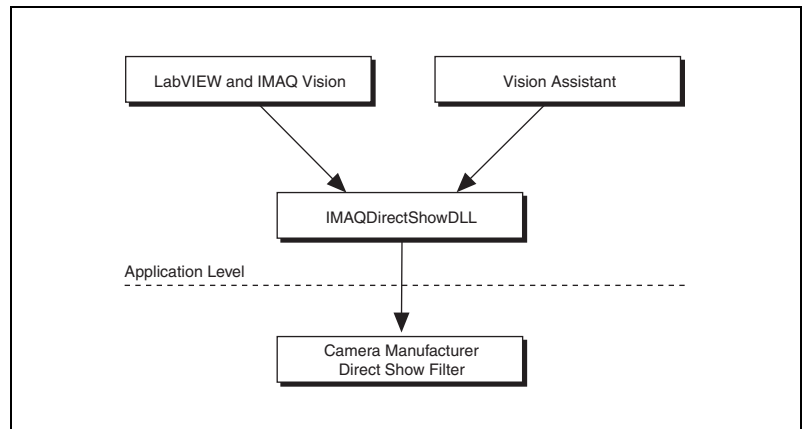

Figure 1. NI-IMAQ for USB Cameras Architecture

NI-IMAQ for USB Cameras VI Location

To access the NI-IMAQ for USB Cameras VIs from within LabVIEW, select **NI Measurements»Vision»IMAQ USB** from the Functions palette of your block diagram, as shown in Figure 2.

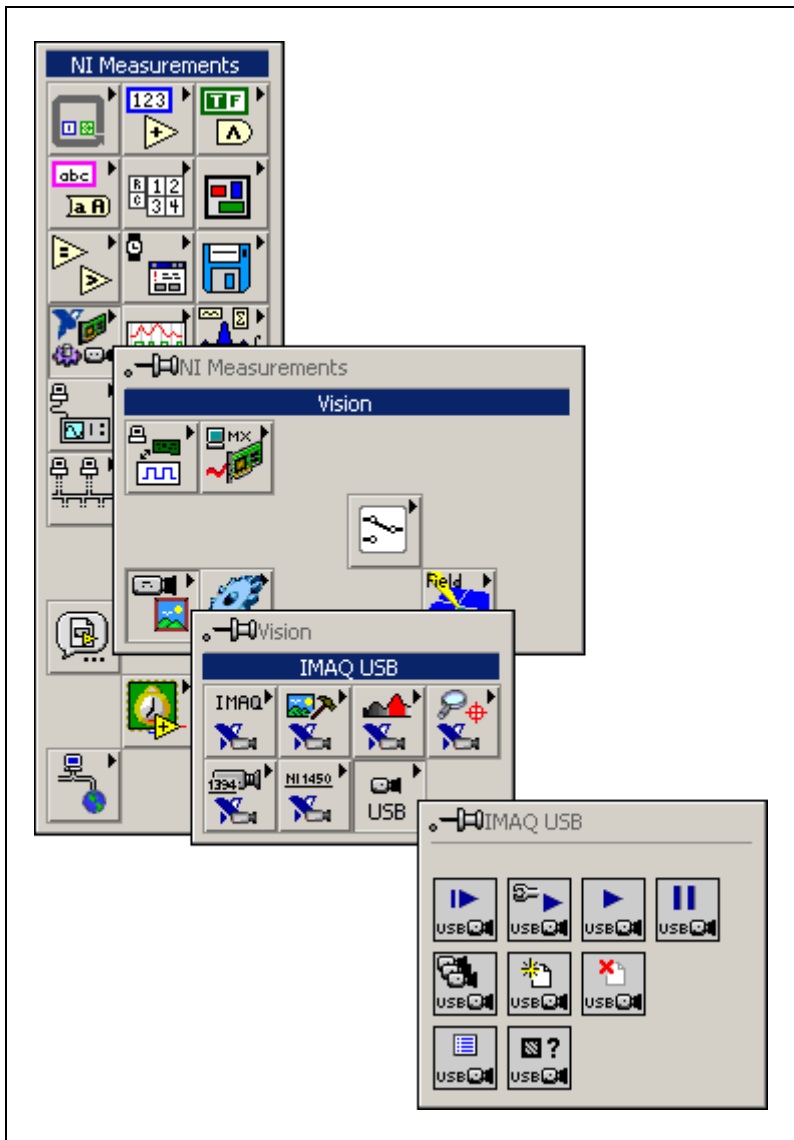

Figure 2. NI-IMAQ for USB Cameras Palette Location



Note For help on specific VIs, select **Help»Show Context Help** from the LabVIEW menu. Place the mouse over a VI on the block diagram, and the context help window will display information about the VI.

Example Programs

The NI-IMAQ for USB Cameras examples illustrate some common applications. You can find these examples in the <LabVIEW>\examples\imaq directory. For a brief text description of an example, open the example VI and select **Windows»Show VI Info**.

Buffer Management

The IMAQ Create and IMAQ Dispose VIs manage image buffers in LabVIEW. IMAQ Create, shown in Figure 3, allocates an image buffer. **Image Name** is a label for the buffer created. Each buffer must have a unique name. **Image Type** specifies the type of image being created. Use **Grayscale (U8)** for 8-bit monochrome images, **Grayscale (I16)** for 16-bit monochrome images, and **RGB (U32)** for RGB color images.



Note If **Image Type** is set to a value incompatible with the current video mode, the **Image Type** value automatically changes to a compatible value.

New Image contains pointer information to the buffer, which is initially empty. When you wire **New Image** to the **Image** terminal of an image acquisition VI, the image acquisition VI allocates the correct amount of memory for the acquisition. If you are going to process the image, you may also need to wire a value to **Border Size**. **Border Size** is the width, in pixels, of a border created around an image. Some image processing functions, such as labeling or morphology, require a border.

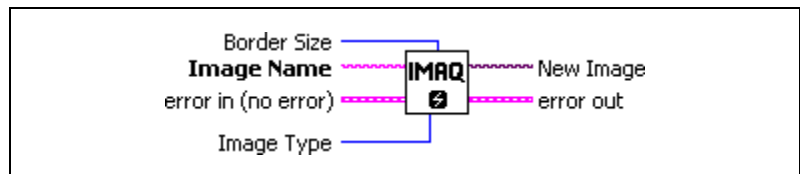

Figure 3. IMAQ Create

IMAQ Dispose, shown in Figure 4, frees the memory allocated for the image buffer. Call this VI only after the image is no longer required for processing.

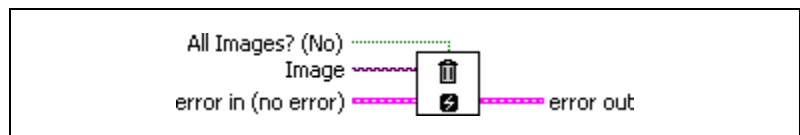

Figure 4. IMAQ Dispose

Acquisition Types

Two types of image acquisitions are available in LabVIEW—snap and grab. The following sections describe and give examples for each acquisition type. NI-IMAQ for USB Cameras does not support simultaneous acquisitions from more than one camera.



Note The NI Vision Assistant USB Acquisition Module always acquires images when an image acquisition step is open. Make sure to close the step before acquiring an image in LabVIEW. Refer to the *NI-IMAQ for USB Cameras and NI Vision Assistant* section of this guide for more information.

Snap

A *snap* acquires a single image into a memory buffer. Use this acquisition mode to acquire a single frame to a buffer. When you invoke a snap, it initializes the device and acquires the next incoming video frame to a buffer. Use a snap for low-speed or single-capture applications. Use IMAQ USB Snap to perform a snap acquisition in LabVIEW. Figure 5 shows a simplified block diagram for using IMAQ USB Snap.

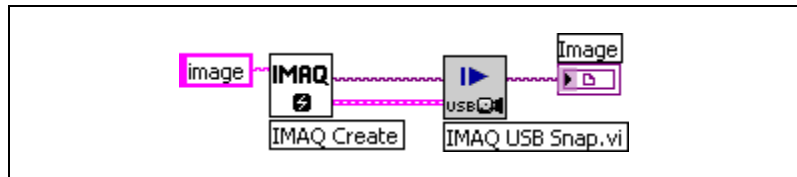

Figure 5. Acquiring an Image Using IMAQ USB Snap

Grab

A *grab* is a continuous, high-speed acquisition of data to a single buffer in host memory. This function performs an acquisition that loops continually on one buffer. You can get a copy of the acquisition buffer by grabbing a copy to a LabVIEW image buffer. You must use two VIs—IMAQ USB Grab Setup and IMAQ USB Grab Acquire—for a grab acquisition in LabVIEW. Call IMAQ USB Grab Setup once to initialize the acquisition and start capturing the image to an internal software buffer. You can call IMAQ USB Grab Acquire multiple times to copy the image currently stored in the internal buffer to a LabVIEW image buffer. After the program finishes copying images, call IMAQ USB Close once to shut down the acquisition. Figure 6 shows a simplified block diagram for using IMAQ USB Grab Setup and IMAQ USB Grab Acquire.

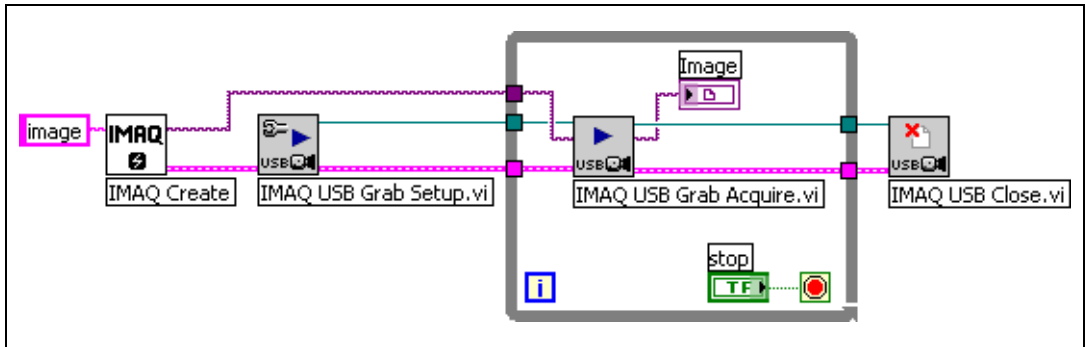

Figure 6. Acquiring Images Using IMAQ USB Grab

NI-IMAQ for USB Cameras and NI Vision Assistant

NI-IMAQ for USB Cameras provides an add-on module for Vision Assistant 7.1 and greater. This module allows you to acquire images from USB cameras and process these images with Vision Assistant.



To access the NI-IMAQ for USB Cameras Vision Assistant Module, select the **Acquire Image** option after launching Vision Assistant, or select the Acquire Image icon on the Vision Assistant menu bar. Either method opens the NI-IMAQ for USB Cameras Image Acquisition window in Vision Assistant.

The NI-IMAQ for USB Cameras Vision Assistant Image Acquisition window allows you to select a camera from a list of USB cameras recognized by the system, set properties of the camera, and acquire images. Figure 7 shows the NI-IMAQ for USB Cameras Image Acquisition window.

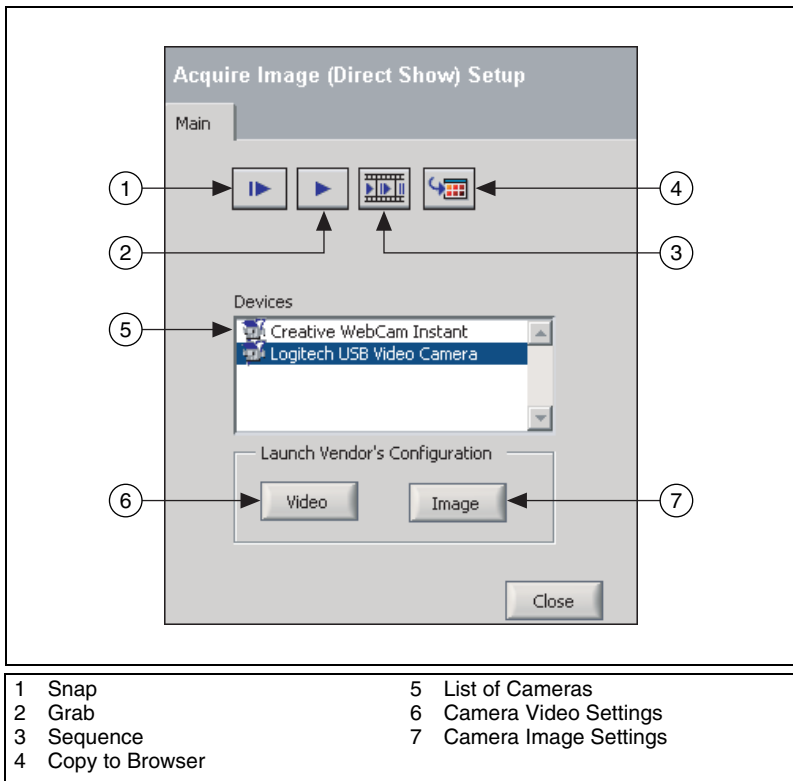

Figure 7. NI-IMAQ for USB Cameras Acquisition Page in Vision Assistant

The following options are available in the NI-IMAQ for USB Cameras Image Acquisition window. Refer to Figure 7 for the location of each option within the window.

- Snap—Acquires a single image from the selected camera.
- Grab—Acquires a continuous image from the selected camera.
- Sequence—Acquires a user specified number of images. Sequence acquisitions are useful for capturing events that change quickly.
- Copy to Browser—Copies the current image in the display to the Vision Assistant Image Browser for processing. Multiple images can be sent to the browser and then processed later using Vision Assistant.
- List of Cameras—Lists the available USB cameras.
- Camera Video Settings—Opens a dialog box with the video settings the camera supports.
- Camera Image Settings—Opens a dialog box with the image settings the camera supports.

Error Codes

Each function returns an error code that indicates the success or failure of the function. The following table describes the error codes returned by each NI-IMAQ for USB Cameras function.

Table 1. NI-IMAQ for USB Cameras Error Codes

Error Code	Description
-1074396032	Not enough memory.
-1074396030	Timeout error.
-1074396028	Internal error. Camera Manufacturer property page produced an error.
-1074396026	Not a valid USB session.
-1074396024	System memory error.
-1074396023	Feature not available in camera. Camera Manufacturer property page produced an error.
-1074396020	Filter name not found.
-1074396018	No acquisition in progress.
-1074396017	Invalid value on Property Page. Camera Manufacturer property page produced an error.
-1074396016	Multiple camera acquisition not supported.
-1074396015	Not able to connect to camera, may be in use.
-1074396014	Invalid image. Make sure the image is not NULL.
0	No error.

National Instruments, NI, ni.com, and LabVIEW are trademarks of National Instruments Corporation. Refer to the *Terms of Use* section on ni.com/legal for more information about National Instruments trademarks. Other product and company names mentioned herein are trademarks or trade names of their respective companies. For patents covering National Instruments products, refer to the appropriate location: **Help»Patents** in your software, the `patents.txt` file on your CD, or ni.com/patents.