

VXI

VXI-1394 User Manual for Windows

Worldwide Technical Support and Product Information

ni.com

National Instruments Corporate Headquarters

11500 North Mopac Expressway Austin, Texas 78759-3504 USA Tel: 512 683 0100

Worldwide Offices

Australia 1800 300 800, Austria 43 0 662 45 79 90 0, Belgium 32 0 2 757 00 20, Brazil 55 11 3262 3599,
Canada (Calgary) 403 274 9391, Canada (Montreal) 514 288 5722, Canada (Ottawa) 613 233 5949,
Canada (Québec) 514 694 8521, Canada (Toronto) 905 785 0085, Canada (Vancouver) 514 685 7530,
China 86 21 6555 7838, Czech Republic 420 2 2423 5774, Denmark 45 45 76 26 00,
Finland 385 0 9 725 725 11, France 33 0 1 48 14 24 24, Germany 49 0 89 741 31 30, Greece 30 2 10 42 96 427,
India 91 80 51190000, Israel 972 0 3 6393737, Italy 39 02 413091, Japan 81 3 5472 2970,
Korea 82 02 3451 3400, Malaysia 603 9131 0918, Mexico 001 800 010 0793, Netherlands 31 0 348 433 466,
New Zealand 0800 553 322, Norway 47 0 66 90 76 60, Poland 48 0 22 3390 150, Portugal 351 210 311 210,
Russia 7 095 783 68 51, Singapore 65 6226 5886, Slovenia 386 3 425 4200, South Africa 27 0 11 805 8197,
Spain 34 91 640 0085, Sweden 46 0 8 587 895 00, Switzerland 41 56 200 51 51, Taiwan 886 2 2528 7227,
Thailand 662 992 7519, United Kingdom 44 0 1635 523545

For further support information, refer to the *Technical Support and Professional Services* appendix. To comment on the documentation, send email to techpubs@ni.com.

© 2003 National Instruments Corporation. All rights reserved.

Important Information

Warranty

The VXI-1394 is warranted against defects in materials and workmanship for a period of one year from the date of shipment, as evidenced by receipts or other documentation. National Instruments will, at its option, repair or replace equipment that proves to be defective during the warranty period. This warranty includes parts and labor.

The media on which you receive National Instruments software are warranted not to fail to execute programming instructions, due to defects in materials and workmanship, for a period of 90 days from date of shipment, as evidenced by receipts or other documentation. National Instruments will, at its option, repair or replace software media that do not execute programming instructions if National Instruments receives notice of such defects during the warranty period. National Instruments does not warrant that the operation of the software shall be uninterrupted or error free.

A Return Material Authorization (RMA) number must be obtained from the factory and clearly marked on the outside of the package before any equipment will be accepted for warranty work. National Instruments will pay the shipping costs of returning to the owner parts which are covered by warranty.

National Instruments believes that the information in this document is accurate. The document has been carefully reviewed for technical accuracy. In the event that technical or typographical errors exist, National Instruments reserves the right to make changes to subsequent editions of this document without prior notice to holders of this edition. The reader should consult National Instruments if errors are suspected. In no event shall National Instruments be liable for any damages arising out of or related to this document or the information contained in it.

EXCEPT AS SPECIFIED HEREIN, NATIONAL INSTRUMENTS MAKES NO WARRANTIES, EXPRESS OR IMPLIED, AND SPECIFICALLY DISCLAIMS ANY WARRANTY OF MERCHANTABILITY OR FITNESS FOR A PARTICULAR PURPOSE. CUSTOMER'S RIGHT TO RECOVER DAMAGES CAUSED BY FAULT OR NEGLIGENCE ON THE PART OF NATIONAL INSTRUMENTS SHALL BE LIMITED TO THE AMOUNT THEREOF PAID BY THE CUSTOMER. NATIONAL INSTRUMENTS WILL NOT BE LIABLE FOR DAMAGES RESULTING FROM LOSS OF DATA, PROFITS, USE OF PRODUCTS, OR INCIDENTAL OR CONSEQUENTIAL DAMAGES, EVEN IF ADVISED OF THE POSSIBILITY THEREOF. This limitation of the liability of National Instruments will apply regardless of the form of action, whether in contract or tort, including negligence. Any action against National Instruments must be brought within one year after the cause of action accrues. National Instruments shall not be liable for any delay in performance due to causes beyond its reasonable control. The warranty provided herein does not cover damages, defects, malfunctions, or service failures caused by owner's failure to follow the National Instruments installation, operation, or maintenance instructions; owner's modification of the product; owner's abuse, misuse, or negligent acts; and power failure or surges, fire, flood, accident, actions of third parties, or other events outside reasonable control.

Copyright

Under the copyright laws, this publication may not be reproduced or transmitted in any form, electronic or mechanical, including photocopying, recording, storing in an information retrieval system, or translating, in whole or in part, without the prior written consent of National Instruments Corporation.

Trademarks

CVI™, LabVIEW™, Measurement Studio™, National Instruments™, ni.com™, NI-488™, NI-488.2™, NI-DAQ™, NI-VISA™, and NI-VXI™ are trademarks of National Instruments Corporation.

FireWire® is the trademark of Apple Computer, Inc., registered in the U.S. and other countries. Other product and company names mentioned herein are trademarks or trade names of their respective companies.

Patents

For patents covering National Instruments products, refer to the appropriate location: **Help»Patents** in your software, the `patents.txt` file on your CD, or `ni.com/patents`.

WARNING REGARDING USE OF NATIONAL INSTRUMENTS PRODUCTS

(1) NATIONAL INSTRUMENTS PRODUCTS ARE NOT DESIGNED WITH COMPONENTS AND TESTING FOR A LEVEL OF RELIABILITY SUITABLE FOR USE IN OR IN CONNECTION WITH SURGICAL IMPLANTS OR AS CRITICAL COMPONENTS IN ANY LIFE SUPPORT SYSTEMS WHOSE FAILURE TO PERFORM CAN REASONABLY BE EXPECTED TO CAUSE SIGNIFICANT INJURY TO A HUMAN.

(2) IN ANY APPLICATION, INCLUDING THE ABOVE, RELIABILITY OF OPERATION OF THE SOFTWARE PRODUCTS CAN BE IMPAIRED BY ADVERSE FACTORS, INCLUDING BUT NOT LIMITED TO FLUCTUATIONS IN ELECTRICAL POWER SUPPLY, COMPUTER HARDWARE MALFUNCTIONS, COMPUTER OPERATING SYSTEM SOFTWARE FITNESS, FITNESS OF COMPILERS AND DEVELOPMENT SOFTWARE USED TO DEVELOP AN APPLICATION, INSTALLATION ERRORS, SOFTWARE AND HARDWARE COMPATIBILITY PROBLEMS, MALFUNCTIONS OR FAILURES OF ELECTRONIC MONITORING OR CONTROL DEVICES, TRANSIENT FAILURES OF ELECTRONIC SYSTEMS (HARDWARE AND/OR SOFTWARE), UNANTICIPATED USES OR MISUSES, OR ERRORS ON THE PART OF THE USER OR APPLICATIONS DESIGNER (ADVERSE FACTORS SUCH AS THESE ARE HEREAFTER COLLECTIVELY TERMED "SYSTEM FAILURES"). ANY APPLICATION WHERE A SYSTEM FAILURE WOULD CREATE A RISK OF HARM TO PROPERTY OR PERSONS (INCLUDING THE RISK OF BODILY INJURY AND DEATH) SHOULD NOT BE RELIANT SOLELY UPON ONE FORM OF ELECTRONIC SYSTEM DUE TO THE RISK OF SYSTEM FAILURE. TO AVOID DAMAGE, INJURY, OR DEATH, THE USER OR APPLICATION DESIGNER MUST TAKE REASONABLY PRUDENT STEPS TO PROTECT AGAINST SYSTEM FAILURES, INCLUDING BUT NOT LIMITED TO BACK-UP OR SHUT DOWN MECHANISMS. BECAUSE EACH END-USER SYSTEM IS CUSTOMIZED AND DIFFERS FROM NATIONAL INSTRUMENTS' TESTING PLATFORMS AND BECAUSE A USER OR APPLICATION DESIGNER MAY USE NATIONAL INSTRUMENTS PRODUCTS IN COMBINATION WITH OTHER PRODUCTS IN A MANNER NOT EVALUATED OR CONTEMPLATED BY NATIONAL INSTRUMENTS, THE USER OR APPLICATION DESIGNER IS ULTIMATELY RESPONSIBLE FOR VERIFYING AND VALIDATING THE SUITABILITY OF NATIONAL INSTRUMENTS PRODUCTS WHENEVER NATIONAL INSTRUMENTS PRODUCTS ARE INCORPORATED IN A SYSTEM OR APPLICATION, INCLUDING, WITHOUT LIMITATION, THE APPROPRIATE DESIGN, PROCESS AND SAFETY LEVEL OF SUCH SYSTEM OR APPLICATION.

Compliance

FCC/Canada Radio Frequency Interference Compliance

Determining FCC Class

The Federal Communications Commission (FCC) has rules to protect wireless communications from interference. The FCC places digital electronics into two classes. These classes are known as Class A (for use in industrial-commercial locations only) or Class B (for use in residential or commercial locations). All National Instruments (NI) products are FCC Class A products.

Depending on where it is operated, this Class A product could be subject to restrictions in the FCC rules. (In Canada, the Department of Communications (DOC), of Industry Canada, regulates wireless interference in much the same way.) Digital electronics emit weak signals during normal operation that can affect radio, television, or other wireless products.

All Class A products display a simple warning statement of one paragraph in length regarding interference and undesired operation. The FCC rules have restrictions regarding the locations where FCC Class A products can be operated.

Consult the FCC Web site at www.fcc.gov for more information.

FCC/DOC Warnings

This equipment generates and uses radio frequency energy and, if not installed and used in strict accordance with the instructions in this manual and the CE marking Declaration of Conformity*, may cause interference to radio and television reception. Classification requirements are the same for the Federal Communications Commission (FCC) and the Canadian Department of Communications (DOC).

Changes or modifications not expressly approved by NI could void the user's authority to operate the equipment under the FCC Rules.

Class A

Federal Communications Commission

This equipment has been tested and found to comply with the limits for a Class A digital device, pursuant to part 15 of the FCC Rules. These limits are designed to provide reasonable protection against harmful interference when the equipment is operated in a commercial environment. This equipment generates, uses, and can radiate radio frequency energy and, if not installed and used in accordance with the instruction manual, may cause harmful interference to radio communications. Operation of this equipment in a residential area is likely to cause harmful interference in which case the user is required to correct the interference at their own expense.

Canadian Department of Communications

This Class A digital apparatus meets all requirements of the Canadian Interference-Causing Equipment Regulations.

Cet appareil numérique de la classe A respecte toutes les exigences du Règlement sur le matériel brouilleur du Canada.

Compliance to EU Directives

Readers in the European Union (EU) must refer to the manufacturer's Declaration of Conformity (DoC) for information* pertaining to the CE marking compliance scheme. The manufacturer includes a DoC for most hardware products except for those bought from OEMs. In addition, DoCs are usually not provided if compliance is not required, for example electrically benign apparatus or cables.

To obtain the DoC for this product, click **Declarations of Conformity Information** at ni.com/hardref.nsf. This Web site lists the DoCs by product family. Select the appropriate product family, followed by your product, and a link to the DoC appears in Adobe Acrobat format. Click the Acrobat icon to download or read the DoC.

* The CE marking Declaration of Conformity contains important supplementary information and instructions for the user or installer.

Contents

About This Manual

How to Use the Manual Set	vii
Conventions	viii
Related Documentation.....	ix

Chapter 1

Introduction

What You Need to Get Started	1-1
VXI-1394 Interface Kit Overview	1-2
Hardware Description	1-2
VXI-1394 Front Panel Features.....	1-3
Advanced Configuration Options.....	1-3
Software Description	1-4
National Instruments Application Software	1-4

Chapter 2

Installation and Configuration

Installing the Software	2-1
Installing the NI-VXI and NI-VISA Software	2-1
Completing the Software Installation.....	2-2
Configuring the Hardware (optional)	2-3
Installing the Hardware.....	2-3
Installing Your PCI-1394 Interface Board	2-4
Installing Your VXI-1394 Interface Board	2-5
Connecting Cables.....	2-6
Powering on the System	2-7
Software Configuration and Verification	2-7
Running MAX and Resman	2-7

Chapter 3 Developing Your Application

NI-VXI, NI-VISA, and Related Terms	3-1
Configuration	3-2
Device Interaction	3-3
Programming for VXI	3-6
Optimizing Large VXIbus Transfers	3-7
Shared Memory	3-8
NI-VXI API Notes	3-8
Compiler Symbols	3-8
Compatibility Layer Options	3-9
Debugging	3-10

Appendix A Specifications

Appendix B Default Settings

Appendix C Advanced Hardware Configuration Settings

Appendix D Common Questions

Appendix E Technical Support and Professional Services

Glossary

Index

About This Manual

This manual contains instructions for installing and configuring the National Instruments VXI-1394 interface kit for Windows:

The VXI-1394 kit is a low-cost, *VXIplug&play*-compliant IEEE 1394 interface that gives external PCI-based computers the capabilities of embedded VXI controllers.

How to Use the Manual Set

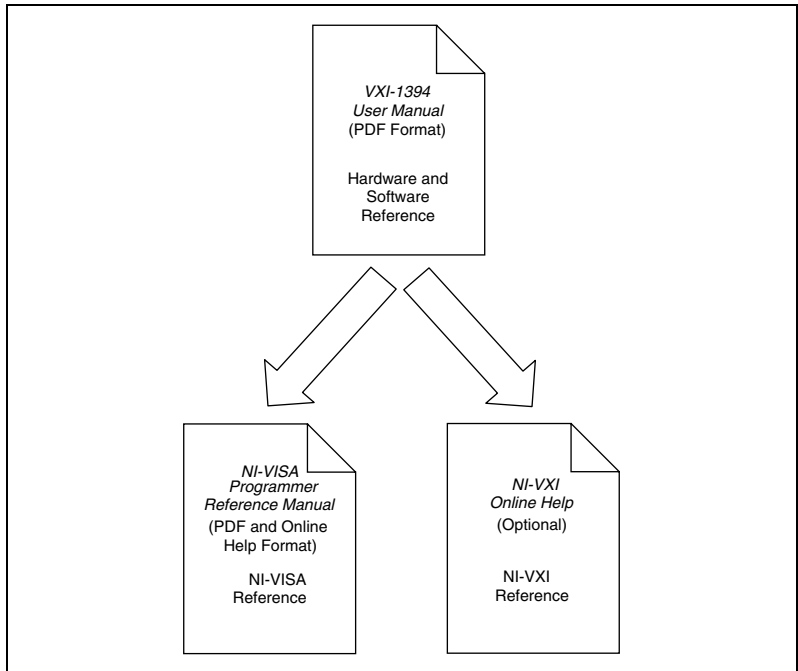

This user manual contains an overview of the VXI-1394 hardware and the NI-VXI/NI-VISA software, guides you through setting up your kit, and helps you get started with application development. You can also use this manual as a reference for the hardware and software default settings and to find the answers to commonly asked questions.

When you have successfully set up your system, you can begin to develop applications in NI-VISA or NI-VXI. NI-VISA online manuals are included in your kit in the form of Adobe Acrobat portable document format (PDF) files. The *NI-VXI Online Help* presents the concepts of VXI and detailed explanations of the NI-VXI functions. Study the descriptions of each function given in the online help to fully understand the purpose and syntax of each function.

The Acrobat manuals and their installed locations are as follows:

- The *NI-VISA User Manual* describes how to program using NI-VISA and can be located at **Start»Programs»VXIipnp»NI-VISA User Manual**.
- The *NI-VISA Programmer Reference Manual* describes in detail the attributes, events, and operations you use in NI-VISA and can be located at **Start»Programs»VXIipnp»NI-VISA Programmer Reference Manual**.

Use the Acrobat Reader program to open the PDF files.



Note You can download Acrobat Reader from the Adobe Web site at www.adobe.com.

Conventions

The following conventions appear in this manual:

»

The » symbol leads you through nested menu items and dialog box options to a final action. The sequence **File»Page Setup»Options** directs you to pull down the **File** menu, select the **Page Setup** item, and select **Options** from the last dialog box.



This icon denotes a note, which alerts you to important information.



This icon denotes a caution, which advises you of precautions to take to avoid injury, data loss, or a system crash.

bold

Bold text denotes items that you must select or click in the software, such as menu items and dialog box options. Bold text also denotes parameter names.

italic

Italic text denotes variables, emphasis, a cross reference, or an introduction to a key concept. This font also denotes text that is a placeholder for a word or value that you must supply.

<code>monospace</code>	Text in this font denotes text or characters that you should enter from the keyboard, sections of code, programming examples, and syntax examples. This font is also used for the proper names of disk drives, paths, directories, programs, subprograms, subroutines, device names, functions, operations, variables, filenames and extensions, and code excerpts.
monospace bold	Bold text in this font denotes the messages and responses that the computer automatically prints to the screen. This font also emphasizes lines of code that are different from the other examples.
<i>monospace italic</i>	Italic text in this font denotes text that is a placeholder for a word or value that you must supply.

Related Documentation

The following documents contain information that you may find helpful as you read this manual:

- ANSI/IEEE Standard 1014-1987, *IEEE Standard for a Versatile Backplane Bus: VMEbus*
- ANSI/IEEE Standard 1155-1998, *IEEE VMEbus Extensions for Instrumentation: VXIbus*
- ANSI/VITA 1-1994, *VME64*
- IEEE Standard 1394-1995, *IEEE Standard for a High Performance Serial Bus*
- *PCI Local Bus Specification*, Revision 2.1, PCI Special Interest Group
- *VXI-6, VXIbus Mainframe Extender Specification*, Rev. 2.0, VXIbus Consortium

Introduction

This chapter describes your VXI-1394 interface kit, lists what you need to get started, and includes a brief description of the hardware and software.

The VXI-1394 interface kit links a PCI-based computer to the VXIbus using the IEEE 1394, or FireWire, high-speed serial bus. This kit makes your computer perform as if it were plugged directly into the VXI backplane, giving your external computer the capability of an embedded computer. You can connect streaming devices such as digital cameras to either the VXI-1394 interface in your VXI mainframe or the PCI-1394 interface in your computer. IEEE 1394 features *hot plug-in* capability under Windows, which means you can add and configure 1394 devices without powering down your system.

Your kit contains a National Instruments VXI-1394 interface module, which plugs into your VXI mainframe and links your computer to the VXIbus.

Your kit also contains an industry-standard OHCI host adapter, which links your PCI-based computer to the IEEE 1394 bus.

Your kit includes the NI-VXI/NI-VISA bus interface software, which is fully *VXIplug&play* compliant. NI-VXI/NI-VISA is the National Instruments implementation of the VISA I/O software standard on which all *VXIplug&play* software components are based.

What You Need to Get Started

To set up and use the VXI-1394 interface kit, you need the following items:

- A computer running Windows 2000/XP/Me/98 Second Edition
- An industry-standard OHCI host adapter
- VXIbus mainframe
- VXI-1394 interface module that plugs directly into a VXI mainframe
- 1394 cable

- National Instruments software CD
- This manual

VXI-1394 Interface Kit Overview

The interface kit described in this manual links a 1394-equipped computer directly to the VXIbus using the IEEE 1394 bus. The VXI-1394 kit uses this high-speed (up to 400 Mbits/s) serial bus to link your computer running Windows to a VXI chassis.



Note You can connect multiple 1394 devices together in a tree topology. However, increasing the complexity of the 1394 bus topology can lower overall system performance.



Caution You cannot connect multiple 1394 devices in a circular bus topology (one which provides more than one data path between any two nodes). Doing so will render your VXI-1394 inoperable and may crash your system.

The VXI-1394 kit includes the NI-VXI/NI-VISA software for Windows, a C-size VXI-1394 module, a 1394 cable, and an industry-standard OHCI host adapter.

A 1394-equipped computer connected to a VXI-1394 interface can function as a VXI Commander and Resource Manager. The VXI-1394 interface kit gives your computer the capability to perform as if it is plugged directly into the VXI backplane as an embedded CPU module. The VXI-1394 transparently translates between the IEEE 1394 and VXI protocols.

The software included with the kit is for Pentium-based computers.

Hardware Description

The VXI-1394 module is a VXIbus device with optional VXIbus Slot 0 capability so that it can reside in any slot in a C-size or D-size chassis. If you enable this capability, the VXI-1394 can automatically determine whether it is located in VXI Slot 0.



Note D-size VXI mainframes have connections for a P3 connector. The VXI-1394, however, does not have this connector and, if configured as a Slot 0 controller, cannot provide the necessary control for VXI devices that need P3 support.



Caution An improper Slot 0 setting may damage the VXI-1394 module and/or the VXI chassis.

The VXI-1394 links the computer to the VXIbus and converts 1394 data transfers into VXIbus data transfers and vice versa. The VXI-1394 includes additional 1394 ports you can use to connect other 1394 devices.

The PCI-1394 is an industry-standard 1394 host adapter on a PCI board, which gives your computer the capability to control 1394 devices. The PCI-1394 also supplies power to the IEEE 1394 bus, which is required by some devices.

VXI-1394 Front Panel Features

The VXI-1394 has the following front panel features.

- Three front panel LEDs
 - **SYSFAIL** LED indicates that the VMEbus SYSFAIL line is asserted.
 - **1394** LED indicates when the VXI-1394 is accessed from the IEEE 1394 bus.
 - **VXI** LED indicates when the VXI-1394 is accessed from the VXIbus.
- Three 1394 6-pin connectors
- Three SMB connectors
 - External clock
 - Trigger output
 - Trigger input
- System reset push-button

Advanced Configuration Options

The default hardware configuration of the VXI-1394 should be acceptable for most systems. Refer to Appendix C, *Advanced Hardware Configuration Settings*, only if your system will make use of the front-panel CLK10 and trigger SMB connectors.

Software Description

The NI-VISA/NI-VXI bus interface software includes a Resource Manager, an interactive configuration and troubleshooting program, a comprehensive library of software routines for VXI/VME programming, a logging utility you can use for debugging, and graphical interactive control programs for interacting with VISA. You can use this software to seamlessly program multiple-mainframe configurations and have software compatibility across a variety of controller platforms.

NI-VISA has a comprehensive library of software routines not only for VXI/VME programming, but also for GPIB, GPIB-VXI, PXI, TCP/IP, and Serial. You can use this software to program instruments connected through different types of interfaces.

Measurement & Automation Explorer (MAX) helps you view your entire test and measurement system and configure various components, whether they are VXI, GPIB, PXI, or Serial devices. You can also add VME devices to your system easily with MAX and view them on a screen display along with the rest of your system.

MAX also features various options for running Resman. You can still execute Resman independently to configure your instruments after a power cycle. But you can also perform resource manager operations directly from MAX or configure it to run Resman automatically at startup.

The NI Spy utility tracks the calls your application makes to National Instruments drivers, including NI-VXI, NI-VISA, and NI-488.2. NI Spy helps you debug your application by clearly highlighting the functions that return errors. You can let NI Spy keep a log of your program's calls to these drivers so that you can check them for errors at your convenience.

National Instruments Application Software

In addition to the NI-VISA/NI-VXI software, you can use the National Instruments LabVIEW, Measurement Studio, and LabWindows™/CVI™ application programs and instrument drivers to ease your programming task. These standardized programs match the modular virtual instrument capability of VXI and can reduce your VXI/VME software development time. These programs are fully *VXIplug&play* compliant and feature extensive libraries of VXI instrument drivers written to take full advantage of direct VXI control. LabVIEW, Measurement Studio, and LabWindows/CVI include all the tools needed for instrument control, data acquisition, analysis, and presentation.

LabVIEW is an easy-to-use, graphical programming environment you can use to acquire data from thousands of different instruments, including IEEE 488.2 devices, VXI devices, serial devices, PLCs, and plug-in data acquisition boards. After you have acquired raw data, you can convert it into meaningful results using the powerful data analysis routines in LabVIEW. LabVIEW also comes with hundreds of instrument drivers, which dramatically reduce software development time, because you do not have to spend time programming the low-level control of each instrument.

Measurement Studio allows you to choose from standard environments such as Microsoft Visual Basic, Visual C++, and Visual Studio .NET to create your application, using tools specific for each language. With Measurement Studio, you can write programs quickly and easily and modify them as your needs change.

LabWindows/CVI is an interactive ANSI C programming environment designed for building virtual instrument applications. LabWindows/CVI delivers a drag-and-drop editor for building user interfaces, a complete ANSI C environment for building your test program logic, and a collection of automated code generation tools, as well as utilities for building automated test systems, monitoring applications, or laboratory experiments.

To use any of these application programs, install them before the NI-VISA/NI-VXI software installation. LabVIEW, Measurement Studio, and LabWindows/CVI integrate the VXI and VISA libraries that are required to support your VXI-1394. You also get hundreds of complete instrument drivers, which are modular, source-code programs that handle the communication with your instrument to speed your application development.

Installation and Configuration

This chapter explains how to set up your test system.

Installing the Software

Use the Setup program that came with your NI-VXI/NI-VISA software to install the entire software package or a software update, or to reinstall software in the event that your files were accidentally erased.

Some of the utilities rely on the LabWindows/CVI Run-Time Engine. This software is installed, if necessary, during the NI-VXI/NI-VISA installation.

Depending on the type of installation you choose, you may need up to 50 MB of free space available on your hard drive to accommodate the NI-VXI and NI-VISA software.

To be compliant with *VXIplug&play* specifications, a VXI controller must provide the VISA I/O driver library standardized by *VXIplug&play*. VISA ensures that your controller can run all *VXIplug&play*-compatible software now and in the future.

The NI-VISA software in this kit is compatible with the WINNT/GWINNT and WIN95/GWIN95 frameworks. With NI-VISA installed on your computer, you can run any *VXIplug&play* software that is compatible with these frameworks. This includes instrument drivers and executable soft front panel software that are included with *VXIplug&play*-compatible instruments from a variety of vendors.

Installing the NI-VXI and NI-VISA Software

This section describes how to install the NI-VXI and NI-VISA software. Please carefully read these directions along with any messages on the screen before making your selections.

You can quit the Setup program at any time by pressing the **Cancel** button.

Setup is an interactive, self-guiding program that installs the NI-VXI and NI-VISA software and configures your system to use the software with the VXI-1394. Complete the following steps to perform the installation.

1. For the CD, select **Start»Run** and enter the following text, where *x* is your CD drive (usually D):

`X:\NIVXI\setup.exe`

and press <Enter>. Typically, this setup program runs automatically when you insert the CD.

2. Click the **Next** button at the **Welcome** screen to start the installation and accept the license agreement.



Note If you have a previous 32-bit (Windows NT/98) version of the NI-VXI software installed, Setup installs the new version over the previous version.



Caution If you want to keep the manufacturer/model name tables or the VME device configuration from a previous installation, be sure to back them up before starting Setup. They are in the `TBL` subdirectory of your NI-VXI directory.

3. Select the type of installation from the **Installation Options** screen.
 - **Typical** setup installs runtime support and NI-VISA development support.
 - **Complete** setup installs everything including NI-VXI API development support. For more information about the NI-VXI API, refer to Chapter 3, *Developing Your Application*.
 - **Custom** setup gives you more control over which driver components you want installed on your system. This option is recommended for advanced users.
4. Click the **Next** button. Confirm that you are ready to install, and click **Next** again to begin the installation.
5. Setup now copies the necessary files to your hard drive and creates program icons.

Completing the Software Installation

1. Please review the information in any `README` files that Setup prompts you to read.
2. When the installation process completes, power off the system for the changes to take effect.

If you backed up the manufacturer and model name files, restore them to the TBL subdirectory of your NI-VXI directory before running MAX.

Configuring the Hardware (optional)

This section contains basic information about configuring your VXI-1394 hardware. Because the default settings for your VXI-1394 hardware are acceptable for most typical applications, this section is optional.

Refer to Appendix B, *Default Settings*, for a complete listing of the hardware and software default settings. Refer to Appendix C, *Advanced Hardware Configuration Settings*, if you want information about other possible settings.

Use MAX to change any of the configuration settings for the VXI-1394. For information on the software, including optional settings, use MAX and its online help. Use the Windows **Start** menu to open the program group for National Instruments, launch MAX and select **Help»Help Topics**.

Installing the Hardware

This section summarizes how to install your VXI-1394 hardware. Your kit contains a VXI-1394 interface module and a PCI-1394 adapter board.



Caution To guard against electrostatic discharge, touch the antistatic plastic packages to a metal part of your computer or chassis before removing the boards from their packages. Your computer or chassis should be plugged in but powered off.

Figure 2-1 shows a system that includes an IEEE 1394-equipped computer, a VXI-1394 and IEEE 1394 devices. Each 1394 device should have only one connection to the 1394 system.

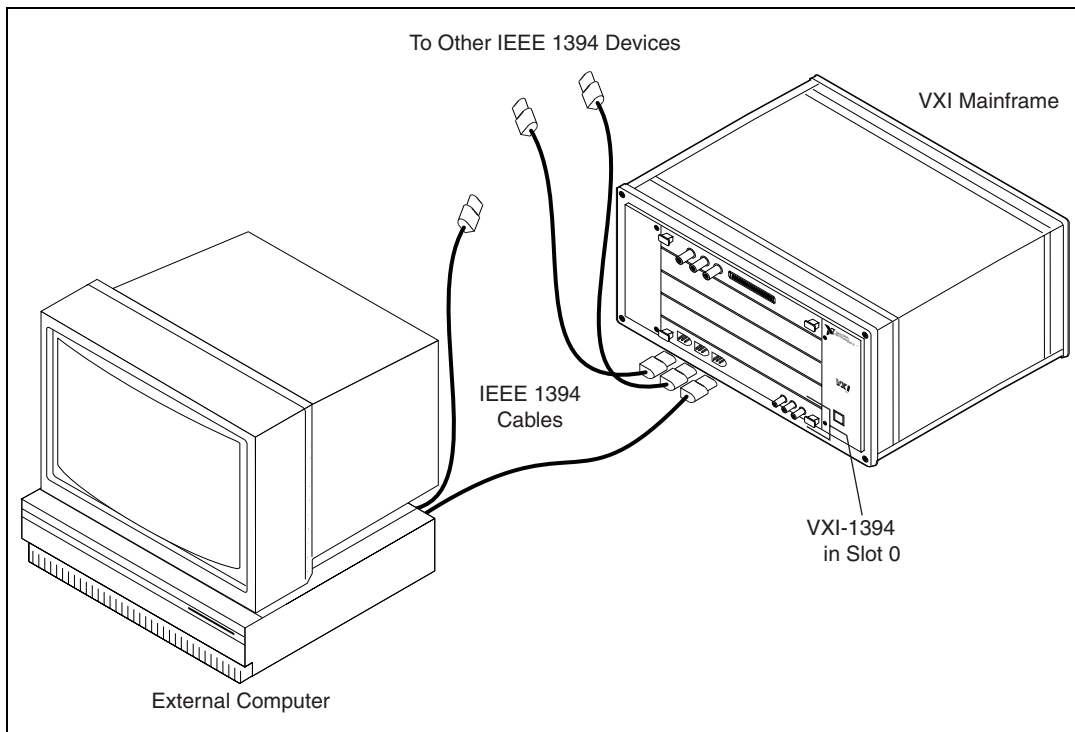

Figure 2-1. Typical VXI-1394 System

Installing Your PCI-1394 Interface Board

To install the PCI-1394 interface board, complete the following steps.

1. Shut down and power off the computer.
2. Remove the computer chassis cover to expose the expansion slots and external access covers.
3. Select an available PCI slot in your computer. The slot you select should support bus mastering. Refer to your computer documentation to determine if the slot you select supports bus mastering.
4. Remove the corresponding expansion slot cover from the chassis.
5. Align the bus connector on the bottom of the host adapter with the PCI bus slot.

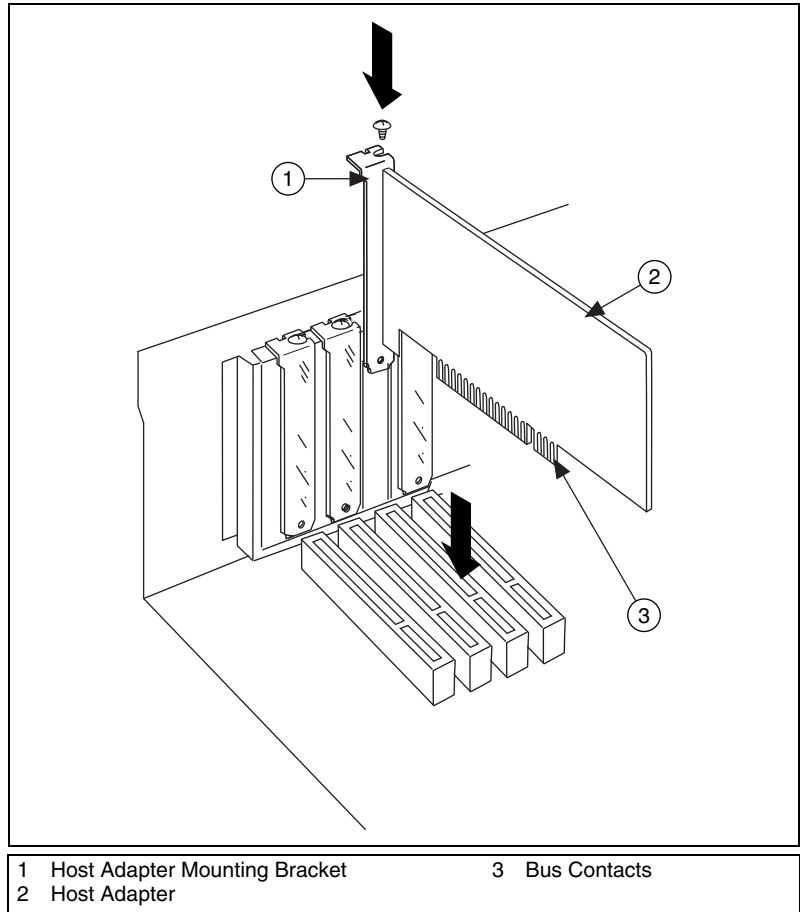

Figure 2-2. Installing the PCI-1394 Host Adapter

6. Carefully press the host adapter into the slot.
7. Secure the host adapter bracket to the computer chassis with the screw from the removed expansion slot cover.

Installing Your VXI-1394 Interface Board

All kits contain a VXI-1394 interface module.

To install the VXI-1394 in Slot 0 of your VXI chassis, complete the following steps.

1. Power off the chassis.
2. Insert the VXI-1394 into the chassis in Slot 0, as shown in Figure 2-1.

3. Power on the chassis.

The VXI-1394 default configuration automatically detects whether it should be the VXI system controller. The VXI system controllers operate certain VXI lines as required for VXI systems. Verify that any other VXI devices with system controller capability that are located in the same chassis are *not* configured as system controller.



Caution Having more than one device configured as system controller can damage the VXI system.

For VXI systems that include VME devices, ensure that the VME devices are not configured in the upper 16 KB (starting from 0xC000) of the A16 address space. This region is reserved for VXI device configuration registers, which are used for initializing, configuring, and interacting with VXI devices. The VXI-1394 also uses this region for this purpose.



Note Also ensure that no VXI devices in your system are configured for logical address 0. This is the default configuration for the VXI-1394.

Connecting Cables

Connect the IEEE 1394 cable to the PCI-1394 host adapter and to the VXI-1394, as shown in Figure 2-1. You can use any available 1394 port for each device. The VXI-1394 has three external ports. The OHCI 1394 host adapter has three external ports.

You can connect any other 1394 devices to any available port on an existing device, but for best results minimize the number of levels in the tree topology. Adding to the number of levels in the tree degrades system performance.



Caution Do *not* cable devices to your 1394 system in such a way as to form a loop. Any device should have only one connection to the 1394 bus. An example of a loop would be a system containing a PCI-1394, a VXI-1394, and a device connected to both. Such a closed loop would break the 1394 system.

Some 1394 devices require different cables than others. Your kit includes one 6-to-6-pin cable to link the VXI-1394 to your computer. Some other devices also require a 6-to-6-pin cable for proper connection to the 1394 system. Many other devices such as camcorders, VCRs, and so on, take a 6-to-4-pin cable.

Powering on the System

1. Be sure all cables are connected securely.
2. Ensure that the VXI-1394 is powered on prior to starting the external computer.
3. Power on the external computer.
4. If your system CMOS setup requires you to enable PCI bus parameters, do so at this time.



Note The PCI bus usually assigns IRQs and port addresses automatically. However, in some PC systems, you may need to manually edit the PCI bus parameters in your CMOS setup. Refer to your computer documentation for further instructions.

5. You can now power on any external devices.

Software Configuration and Verification

Running MAX and Resman

1. Run the MAX program. You must run Resman every time the chassis or computer power is cycled so that your application can access devices in the VXI chassis. You can also configure MAX to run Resman automatically at every computer startup by selecting **Tools»NI-VXI»VXI Options** and selecting the appropriate checkbox.
2. After you run Resman, you are ready to use MAX to interactively configure the National Instruments hardware in your system. Use the right-click help for information about the various configuration options.

After you finish configuring the system through MAX, verify the configuration through one of the interactive control utilities. Use VIC under NI-VXI (**Start»Programs»National Instruments»VXI»NI-VXI API»VIC**) or VISAIC under NI-VISA (**Start»Programs»National Instruments»VISA»VISA Interactive Control**).

Developing Your Application

This chapter discusses the software utilities you can use to start developing applications that use NI-VXI.

After installing the NI-VXI software, you can begin developing your VXI/VME application. Be sure to check the release notes for the latest application development notes and changes.

NI-VXI, NI-VISA, and Related Terms

Before you develop your application, it is important to understand the difference between *NI-VXI*, *NI-VISA*, and similar terms.

- *NI-VXI* is the software package that ships with National Instruments VXI and VME controllers. NI-VXI includes Measurement & Automation Explorer (MAX), NI-VISA, NI Spy, Resource Manager (Resman), VXI device drivers, and other utilities for configuring and controlling your VXI or VME system.
- *NI-VISA* is the native API for communicating with VXI/VME devices. NI-VISA is the National Instruments implementation of the VISA I/O standard, which is a common interface to many types of instruments (such as VXI, GPIB, PXI, Serial, TCP/IP, and so on). NI-VXI is optimized for use through NI-VISA, and NI recommends using NI-VISA to develop all new VXI/VME applications.
- The *NI-VXI API* is an optional development environment that is not part of the default NI-VXI installation. The NI-VXI API was developed before NI-VISA; whereas NI-VXI still supports the NI-VXI API, NI recommends using NI-VISA for all new VXI/VME applications. If you must develop an application using the older NI-VXI API, run the NI-VXI installer and perform a Complete install and select the appropriate option in the custom installation screen. Be sure to review the [NI-VXI API Notes](#) section.
- The *NI-VXI compatibility layer* allows older programs that use the NI-VXI API to communicate with VXI devices through VISA. Using this compatibility layer, older programs can run in NI-VXI 3.0 or later without being rewritten to use the VISA interface. This layer installs with NI-VXI by default. It should be completely transparent and

provide a high level of performance; however, there may be some slight changes in behavior for certain applications.

Your software features several system development utilities including MAX, Resman, NI Spy, VISA Interactive Control (VISAIC), and VXI Interactive Control (VIC, optional). You can also access online help and a variety of examples to learn how to use NI-VXI for certain tasks.

Each component assists you with one of four development steps: configuration, device interaction, programming, and debugging.

You can access the utilities, help files, and release notes through the Windows **Start** menu by opening the **National Instruments»VXI** or **National Instruments»VISA** program groups.

Configuration

The configuration utilities in your software kit are Resman and MAX.

Resman performs VXI Resource Manager functions as described in the VXIbus specification. Resman configures all devices on the VXI backplane for operation and allocates memory for devices that request it. Resman does not require you to specify any settings; it automatically performs the VXI resource management whenever you run it.



Note Power cycling resets all devices, so you must run Resman to reconfigure your system every time you cycle the power on the chassis.

MAX presents a graphical display of your entire test and measurement system to help you configure various components. When you launch MAX, you see all your devices (including VXI) on the screen. You can view the properties (such as logical address, address space, and so on) of each device by clicking the device in the configuration tree. To see additional configuration options for a given device, right-click the device in the configuration tree. When you access the properties of most National Instruments devices by right-clicking, you can configure the hardware settings by selecting **Hardware Configuration**.

MAX and Resman are designed to work together. You can run Resman through MAX by either clicking the **Run VXI Resource Manager** button in the toolbar or right-clicking a specific VXI system on which to run Resman, as shown in Figure 3-1. You can also select **Tools»NI-VXI»VXI Resource Manager** to run Resman on all VXI systems. From the **VXI Options** dialog box in the **Tools»NI-VXI** menu, you can also use MAX to

configure Resman to run on all VXI systems automatically when the computer boots. Resman reports to MAX all errors it finds in your system. When you view your VXI system in MAX, you can easily spot any errors that Resman found while configuring the system.

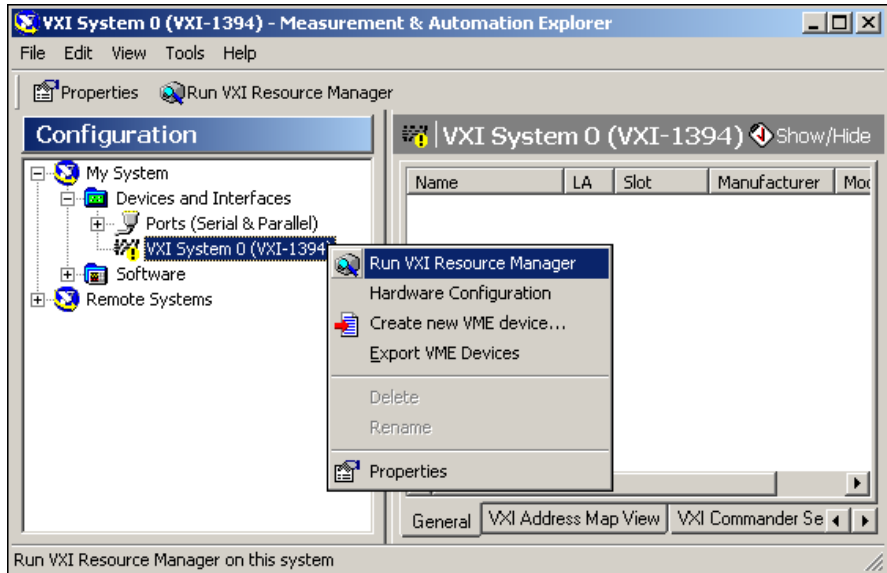

Figure 3-1. Right-Click a VXI System in MAX to Run Resman on that System

After Resman detects and configures all your VXI/VME devices, you can use MAX to view specific information about each device in your system. The default MAX view of a VXI system shows the **General** tab window, which contains a summary of key information about each device, including its device name, logical address, model name, and other data.

For more information about MAX, refer to its online help by selecting the **Help»Help Topics** menu.

Device Interaction

You can interact with your VXI/VME devices using the VISA Interactive Control (VISAIC) utility. VISAIC allows you to control your VXI/VME devices without using LabVIEW, Measurement Studio, or another programming language. You can also control your devices in MAX by right-clicking a device name and selecting **Open VISA Session**.



Note You can also use VXI Interactive Control Program (VIC) to control your VXI/VME devices and develop and debug VXI application programs. VIC is not included in the default NI-VXI installation. To install VIC, choose either a Complete install or select **NI-VXI API Development** from the custom installation screen in the installer.

You can launch VISAIC (or VIC) from the **Tools** menu in MAX or from the **VISA** or **VXI** subgroups in **Start»Programs»National Instruments**.

Try the following in VISAIC: In the tree view, navigate using your mouse to the VISA resource for your controller—probably **VXI0::0::INSTR**, representing the VXI system 0, logical address 0 instrument resource, as shown in Figure 3-2.

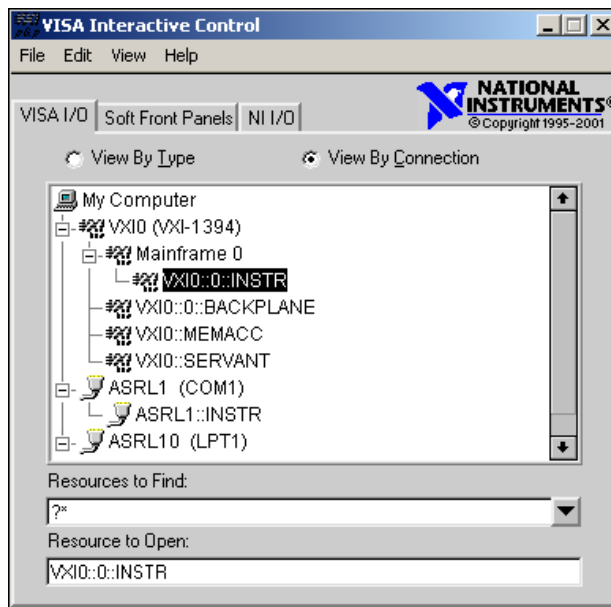

Figure 3-2. Select Your Controller in VISAIC

Open the selected resource and navigate to the **Register I/O** tab. In this tab, you can read registers on your device, such as the VXI device configuration registers. Execute the **viIn** operation (called **In** in LabVIEW compatibility mode) with the default parameters. The **Data Value** field shows the I/O operation result, such as `0x9ff6`. The **Return Value** field shows the function status, such as 0 for `VI_SUCCESS`, as shown in Figure 3-3.

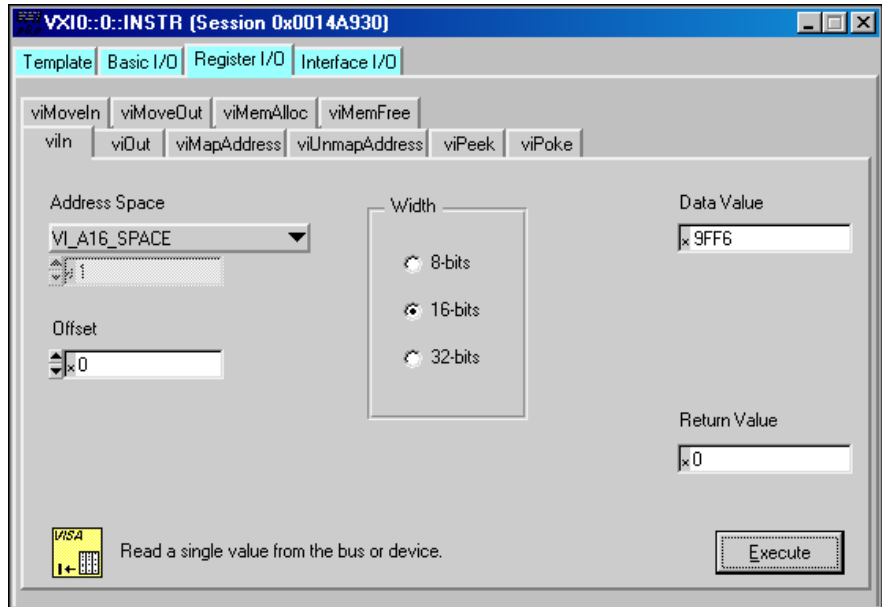

Figure 3-3. Successful viIn Access in the VISAIC Register I/O Tab
(This Dialog Box May Look Slightly Different for LabVIEW Users)

If the data value ends in `ff6`, you have successfully read the National Instruments manufacturer ID from your VXI/VME controller's ID register.

You may now want to read the configuration registers from other VXI devices in your system by opening the devices in VISAIC. Try reading a register from each device listed in the MAX view of your VXI system. This way, you can verify that your VXI controller can access each device in your VXI system successfully.

You can also access VXI and VME devices configured in A16, A24, or A32 space by opening the VXI MEMACC resource, which is VISA's representation of VXI memory. For more information about VISAIC operations and commands, refer to the online help in the **Help** menu and the context-sensitive help (such as **What's This?**), available by right-clicking in any panel.

Programming for VXI

NI-VISA and the NI-VXI API are the two National Instruments programming interfaces for accessing your VXI/VME instruments. With NI-VXI 3.0 or later, NI-VISA is the native API for communicating with a VXI or VME system, and NI recommends using it for all new applications. Older programs that use the NI-VXI API now use the NI-VXI-to-NI-VISA compatibility layer to communicate with the VXI devices. Using this layer, older programs can run in NI-VXI 3.0 or later without being rewritten to use the VISA interface.



Note The NI-VXI API development environment is not installed by default as part of the NI-VXI installation. If you must develop an application using the older NI-VXI API, run the NI-VXI installer and perform a Complete install or select the appropriate option in the custom installation screen. Be sure to review the [NI-VXI API Notes](#) section.

NI-VISA is the National Instruments implementation of the VISA API as the *VXIplug&play* standard defines. It provides a common interface to many types of instruments (such as VXI, GPIB, PXI, Serial, TCP/IP, and so on) and therefore is especially useful in situations where you are using multiple types of instruments.

Both NI-VISA and the NI-VXI API include functions for register-level access to VXI instruments and messaging capability to message-based devices. You can also use either interface to service asynchronous events such as triggers, signals, and interrupts, and also assert them. Compatibility with the NI-VXI API is included for legacy applications only—NI recommends that you write all new VXI/VME applications in VISA.

The best way to learn NI-VISA programming is by reviewing the example programs your software includes. The examples directory contains working VISA programs that illustrate many different types of applications. You can find these examples in the `VXI\pnp\WinNT\NIv\isa\Examples` directory.

If you are just getting started, you should learn how to access registers with high-level calls and send messages with word-serial functions. The NI-VISA examples for these tasks are `HighReg.c` and `RdWrt.c`. Refer to the other examples as you try more advanced techniques. Consult the *NI-VISA User Manual* or online help for additional information on these topics.

Table 3-1 summarizes the topics the example programs address. All files are in the `VXI\pnp\WinNT\NIvisa\Examples` directory, in the subdirectories listed below.

Table 3-1. NI-VISA/NI-VXI Examples

Coverage	NI-VISA Example	NI-VXI Example (Optional)
Message-Based Access	General\RdWrt.c	VXIws.c
High-Level Register Access	VXI-VME\HighReg.c	VXIhigh.c
Low-Level Register Access	VXI-VME\LowReg.c	VXIlow.c
Sharing Memory	VXI-VME\ShareSys.c	VXImem.c
Interrupt Handling	VXI-VME\AsyncIntr.c and WaitIntr.c	VXIint.c
Trigger Handling	VXI-VME\WaitTrig.c	VXItrig.c



Note MAX includes configuration options that affect low-level functions and shared memory, as well as trigger mappings and other attributes of your VXI system. Refer to the MAX online help for information regarding these options.

Optimizing Large VXIbus Transfers

For best performance, keep the following in mind when using `viMove()` or `VXImove()`:

- Make sure your buffers are 32-bit aligned.
- Transfer 32-bit data whenever possible.
- Use VXI block access privileges to significantly improve performance to devices that are capable of accepting block transfers.
- To optimize move performance on virtual memory systems, lock the user buffer in memory yourself so the move operation does not need to lock the buffer.
- To optimize move performance on paged memory systems, use a contiguous buffer so the move operation does not need to build a scatter-gather list for the user buffer.



Note `viMemAlloc()` or `VXImemAlloc()` returns 32-bit aligned, page-locked, continuous buffers which work efficiently with the move operations.

Shared Memory

In the Hardware Configuration settings for your controller in MAX, you can share memory from your computer to the VXI bus. Right-click any setting or consult the MAX online help for more information. You can access shared memory on your computer using `viMemAlloc()` in VISA (or `VXImemAlloc()` in the NI-VXI API). Use MAX to view the VXI address where your shared RAM is allocated, or determine this information programmatically using VISA's `viGetAttribute()`.

NI-VXI API Notes

The following notes apply only if you are using the NI-VXI API. We recommend that all new VXI/VME applications use the NI-VISA API, but you can still develop with the older NI-VXI API for compatibility with legacy code.

Compiler Symbols

You may need to define certain compiler symbols so that the NI-VXI library can work properly with your program. The required symbol indicates your operating system platform; for example, `VXINT` designates the application as a Windows 2000/NT/XP/Me/98 application.



Note LabWindows/CVI automatically defines the correct symbol. You do not need to define `VXINT` when using LabWindows/CVI.

The additional symbol `BINARY_COMPATIBLE` is optional. It ensures that the resulting application is binary compatible with other National Instruments VXI controllers using the same operating system. This symbol may cause a slight performance degradation when you use low-level VXIbus access functions.

You can define these symbols using `#define` statements in your source code or using the appropriate option in your compiler (typically either `-D` or `/D`). If you use `#define` statements, they must appear in your code before the line that includes the NI-VXI API header `nivxi.h`.

Compatibility Layer Options

Although NI-VXI supports multiple VXI controllers through NI-VISA, the NI-VXI API supports only a single controller. To specify which controller the emulation layer should use, run MAX. Select **Tools»NI-VXI»VXI Options**. Select the VXI system that will support the emulation layer.

In NI-VXI 3.0 or later, when you enable for triggers or interrupts, only the local controller is enabled. In the NI-VXI API functions for enabling triggers and interrupts, the controller parameter is ignored. If you need to enable a remote controller for triggers, use the MAX frame resource to map the trigger back to the local controller.

The interrupt and trigger routing in the NI-VXI 3.0 or later low-level drivers is somewhat different from the default routing in previous versions of NI-VXI. Therefore, the compatibility layer may behave differently than the original NI-VXI API with regard to these settings. In particular, if you are receiving triggers on an external controller, you may need to modify the trigger configuration on your extender module using MAX. In general, interrupts are routed automatically based on the interrupt configuration the resource manager detects. Whether the changed routing behavior affects your program is application dependent.

Because VISA is an instrument-centric API, certain functions from the more controller-centric NI-VXI API do not match perfectly with a VISA counterpart. When an application enables an event with the NI-VXI API compatibility layer, each logical address is enabled for that event separately. For example, if the application enables an interrupt level, VISA will enable the interrupt on each logical address, one at a time, until all the devices are enabled. This means that some interrupts could be lost from devices with higher numbered logical addresses. MAX provides an option for users to pick which logical address is enabled first. Select **Tools»NI-VXI»VXI Options**. Set **Prioritized Signal LA** to the logical address of the device that generates the events. This prevents possible loss of events from that device.

Debugging

NI Spy and VISAIC are useful utilities for identifying the causes of problems in your application.

NI Spy tracks the calls your application makes to National Instruments programming interfaces, including NI-VISA, NI-VXI, and NI-488. NI Spy highlights functions that return errors, so during development you can quickly spot which functions failed during a program's execution. NI Spy can log the calls your program makes to these drivers so you can check them for errors at your convenience, or use the NI Spy log as a reference when discussing the problem with National Instruments technical support. Figure 3-4 shows an example of a normal error returned from a call to `viMemAlloc` when no memory has been shared.

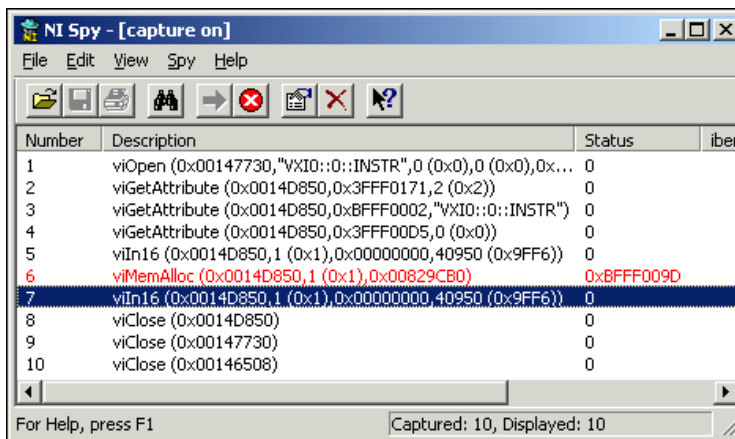

Figure 3-4. NI Spy

VISAIC, discussed in the *Device Interaction* section, is an excellent platform for quickly testing instruments and learning how to communicate with them.

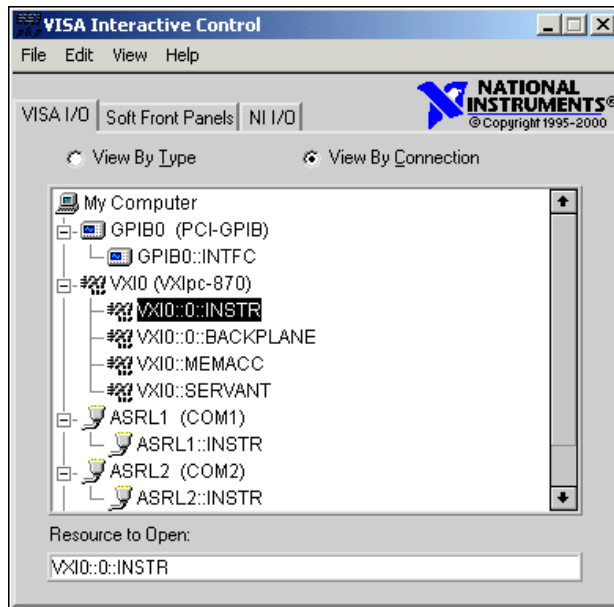

Figure 3-5. VISAIC

Specifications

This appendix lists the specifications for the VXI-1394 module.

Requirements

VXIbus configuration space..... 64 B
A24 or A32 space..... Programmable
Default None

Environmental

Temperature
Operating 0 to 55 °C
Storage -20 to 70 °C

Relative humidity
Operating 10 to 90% noncondensing
Storage 5 to 95% noncondensing

EMI FCC Class A verified, EC verified

Functional shock
MIL-T-28800E Class 3 (30 g half-sine shock pulse)
Also meets IEC 60068-2-27

Random vibration
MIL-T-28800E, MIL-STD-810E Category 1
Operational 5 to 500 Hz, 0.3 g_{rms}
Nonoperational 5 to 500 Hz, 2.4 g_{rms}

Power Requirement

+5 V
Typical 2.23 A
Maximum (fused) 7 A

-5.2 V	
Typical.....	176 mA
Maximum (fused).....	1 A
-2 V	
Typical.....	89.5 mA
Maximum (fused).....	1 A
+12 V	
Typical.....	750 μ A
Maximum (fused).....	1 A

Physical

Dimensions

Fully enclosed, shielded VXI C-size board
 233.35 mm by 340 mm (9.187 in. by 13.386 in.)

Weight

VXI-1394.....1.11 kg (2.45 lb)
 (No DRAM installed)

I/O connectors

6-pin 1394.....3
 SMB.....3
 GPIB (optional).....1

Slot requirementsSingle VXI C-size slot

CompatibilityFully compatible with
 VXI specification

VXI keying classClass 1 TTL

MTBFContact factory

IEEE 1394 Capability Descriptions

Speed support100, 200, and 400 Mbits/s

Protocol support.....Asynchronous Quadlet and Block

Data payload packet sizes Up to 2,048 bytes

Asynchronous target and initiator

VMEbus Capability Codes

A32, A24, A16 (master)

VMEbus master A32, A24, and A16 addressing

A32, A24, A16 (slave)

VMEbus slave A32, A24, and A16 addressing

D64, D32, D16, D08(EO) (master)

VMEbus master D64, D32, D16, and D08 data sizes

D64, D32, D16, D08(EO) (slave)

VMEbus slave D64, D32, D16, and D08 data sizes

BLT, MBLT (master)

VMEbus master block and D64 transfers

BLT, MBLT (slave)

VMEbus slave block and D64 transfers

RMW (master)

VMEbus master read/modify/write transfers

RMW (slave)

VMEbus slave read/modify/write transfers

RETRY (master)

VMEbus master retry support

RETRY (slave)

VMEbus slave retry support

FSD

First slot detector

SCON

VMEbus System Controller (Automatic Detection)

PRI, RRS

Prioritized or Round Robin Select arbiter

ROR, FAIR

Release on Request and FAIR bus requester

IH(7-1)

Interrupt handler for levels 7–1

I(7-1)

Interrupt requester for levels 7–1

D32, D16, D08(O) (Interrupt Handler)

VMEbus D32, D16, D08(O) interrupt handler

D32, D16, D08(O) (Interrupter)

VMEbus D32, D16, D08(O) interrupter

ROAK, RORA

Release on Acknowledge or Register Access interrupter

BTO(x)

VMEbus bus timer (programmable limit)

LOCK

Can lock the VMEbus for indivisible transfers

Default Settings

This appendix summarizes the default settings for the hardware and software in the VXI-1394 kit. If you need more information about a particular setting, or if you want to try a different configuration, refer to Appendix C, *Advanced Hardware Configuration Settings*, for your hardware reference and to the MAX online help for your software reference.



Note There are no hardware settings on the PCI-1394 board.

Hardware Settings

Table B-1. VXI-1394 Hardware Default Settings

Hardware Component	Default Setting
W1—VXIbus Slot 0/Non-Slot 0	Automatic detection
S6—VXIbus CLK10 source	From onboard oscillator
S5—External trigger termination	OFF: unterminated
S3—SMB CLK10 direction	IN: receive CLK10 signal
S2—SMB CLK10 termination	OFF: ignored
S4—Polarity of external SMB CLK10	Inverted
S7—Configuration EEPROM	Do <i>not</i> load from factory setting

Software Settings

Table B-2. MAX Device Tab Default Settings

Editor Field	Default Setting
Logical address	0
Device class	Message based
Size of Servant area	0
System interrupt level	Disabled
Number of handlers	1
Number of interrupters	0

Table B-3. MAX Shared Memory Tab Default Settings

Editor Field	Default Setting
Memory sharing	Do not share memory
Shared RAM size	A16—N/A A24—256 B A32—64 KB
Reserved physical memory	0
Lower half window byte swapping	Disabled
Upper half window byte swapping	Disabled
Map upper and lower halves at same PCI address	Disabled

Table B-4. MAX VXI Bus Tab Default Settings

Editor Field	Default Setting
Bus timeout value	125 μ s
VXI retry generation	Enabled
Automatic retries	Disabled
A24/A32 write posting	Disabled
Transfer limit	256
Requester mode	Release on Request
Request level	3
Fair requester	Enabled
Bus arbitration mode	Prioritized
Arbiter timeout	Enabled



Advanced Hardware Configuration Settings

This appendix describes the factory-default and alternate hardware configuration settings of the VXI-1394. The board is set at the factory for the most commonly used configuration. Use this appendix if you want to try a different hardware configuration or if you would like more information on a particular setting. This information is intended for more advanced users.

Hardware Default Settings

The following hardware configuration settings are user configurable.

- VXIbus Slot 0/Non-Slot 0
- Configuration EEPROM
- VXIbus CLK10 routing
- Trigger input termination

Figure C-1 shows the factory-default settings of the user-configurable jumper and switches on the VXI-1394. The slot selection jumper and six switches are located in the corner of the board behind the front panel SMB connectors.



Note Do *not* attempt an alternate setting unless you are familiar with its purpose. In addition, do not reconfigure any switches or jumpers not described in this appendix unless directed by National Instruments support.

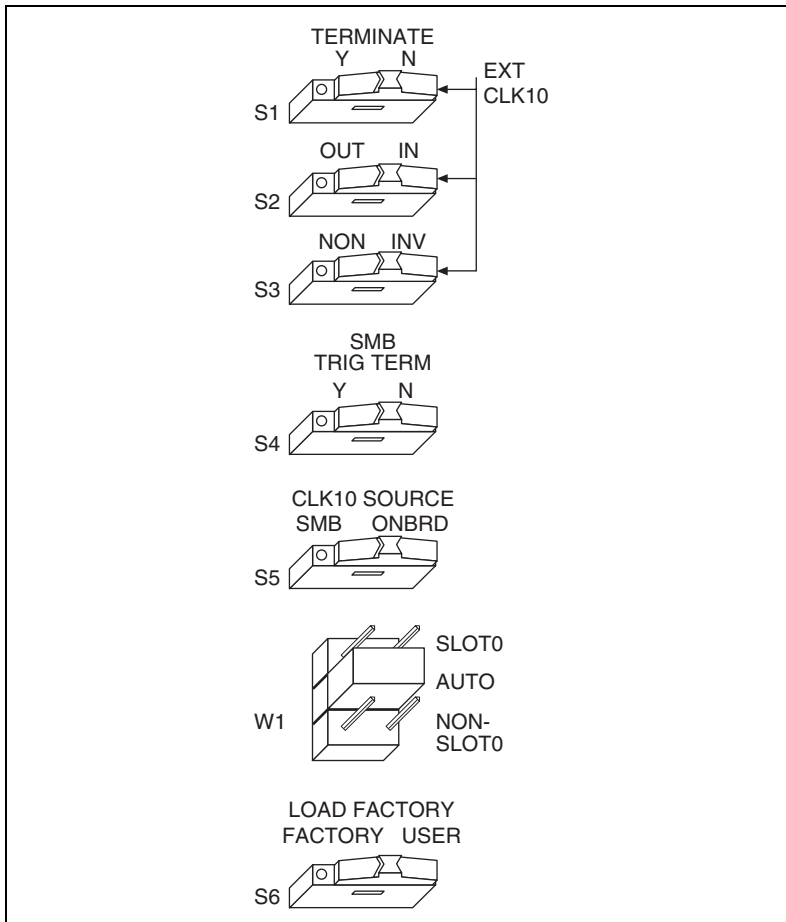

Figure C-1. VXI-1394 Default Configuration Settings

VXIbus Slot 0/Non-Slot 0

The VXI-1394 is configured at the factory to automatically detect if it is installed in Slot 0 of a VXIbus mainframe. With automatic Slot 0 detection, you can install the VXI-1394 into any VXIbus slot.

You can manually configure the VXI-1394 for either Slot 0 or Non-Slot 0 operation by defeating the automatic-detection circuitry. Use the three-position jumper W1 to select automatic Slot 0 detection, Slot 0, or Non-Slot 0 operation. Figure C-2 shows these three settings.



Caution Do *not* install a device configured for Slot 0 into another slot without first reconfiguring it to either Non-Slot 0 or automatic configuration. Neglecting to do this could damage the device, the VXIbus backplane, or both.



Note The setting of any switch shown with this pattern (▨) has no bearing on the configuration described in any of the following figures. For example, Figure C-2 shows switch S6 merely because of its close proximity to W1.

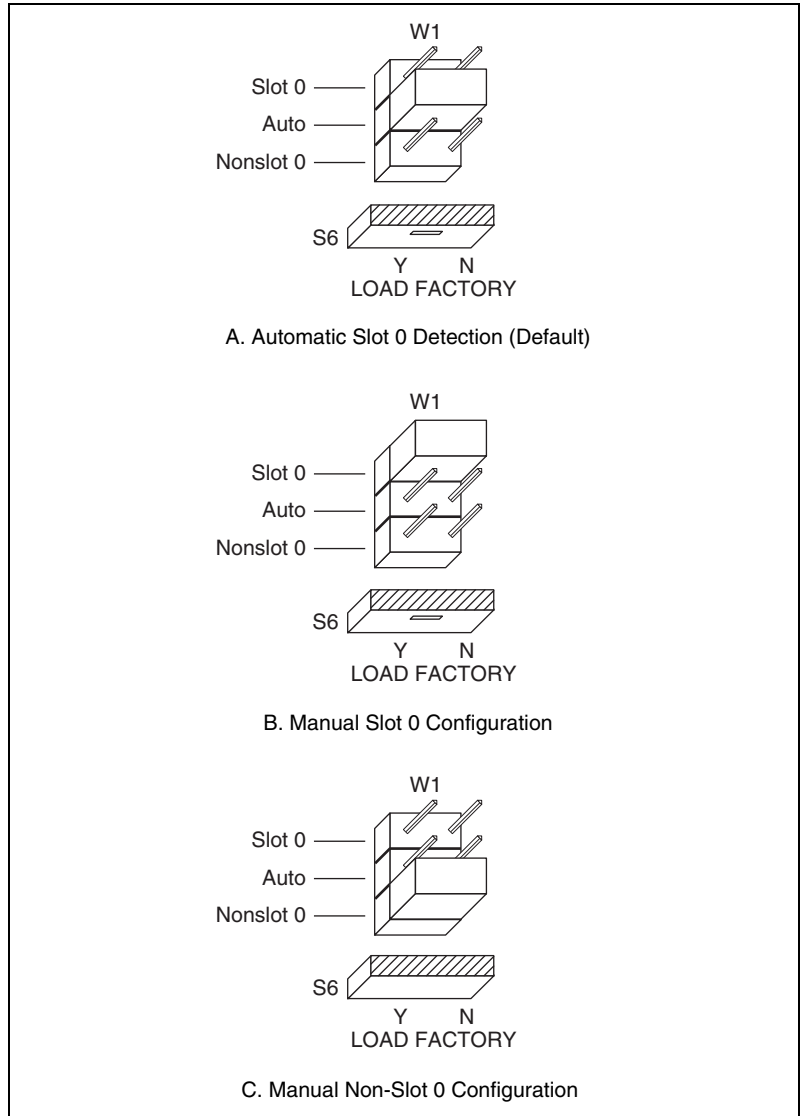

Figure C-2. VXIbus Slot Configuration

When the VXI-1394 is installed in Slot 0, it becomes the VXIbus System Controller. In this role, it has VXIbus Data Transfer Bus Arbiter circuitry that accepts bus requests on all four VXIbus request levels, prioritizes the requests, and grants the bus to the highest priority requester. As VXIbus System Controller, the VXI-1394 also uses an onboard 16 MHz oscillator to drive the 16 MHz VXIbus system clock.

As required by the VXIbus specification, the VXI-1394 drives the 10 MHz signal CLK10 on a differential ECL output when installed in Slot 0. The VXI-1394 generates a 1% accurate CLK10 signal with the onboard oscillator, or can route a 10 MHz clock from an external high-accuracy source. When not installed in Slot 0, the VXI-1394 only receives the CLK10 signal.

Configuration EEPROM

The VXI-1394 has an onboard EEPROM, which stores default register values that are loaded at power-on. The EEPROM is divided into two halves—a factory-configuration half and a user-configuration half. Both halves were factory configured with the same configuration values so you can modify the user-configurable half, while the factory-configured half stores a back-up of the default settings.

The Load Factory switch (switch S6) causes the VXI-1394 to boot off the factory-configured half instead of the user-modified settings. This is useful in the event that the user-configured half of the EEPROM becomes corrupted in such a way that the VXI-1394 boots to an unusable state.

Figure C-3 shows the configuration settings for EEPROM operation.

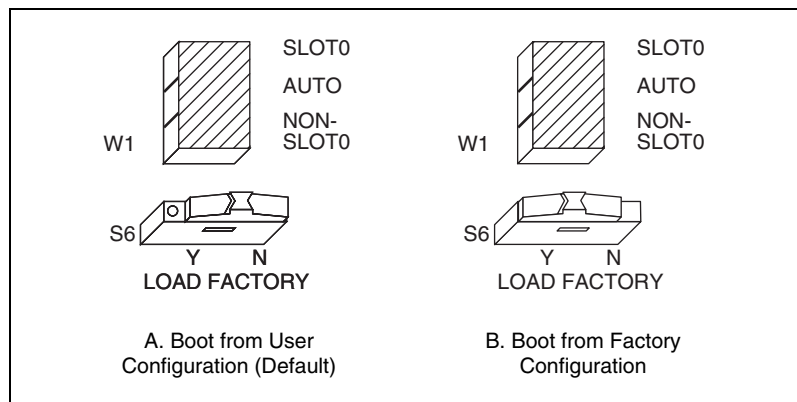



Figure C-3. EEPROM Operation

VXIbus CLK10 Routing

When the VXI-1394 is installed in Slot 0 of your mainframe, it supplies the VXIbus CLK10 signal. The VXI-1394 has four hardware switches that work together to control various aspects of CLK10 routing. Read this section carefully and notice that if you change one switch, you may need to change another. This section includes several diagrams that show how to configure the four switches to accomplish various CLK10 configurations.

Notice that the configuration of one switch may make the setting of another switch irrelevant. For example, only switches S2 and S3 are relevant if you install the VXI-1394 in a slot other than Slot 0. The drawings use the  pattern to depict switches that are either irrelevant or disabled for a particular CLK10 configuration.

Switch S4 uses this pattern in all of the CLK10 drawings. It deals with the external trigger input SMB and is discussed later in this appendix.

The VXI-1394 can use two different sources to generate the VXIbus CLK10 signal—an onboard oscillator or the external CLK SMB connector. Use switch S5 to select between these options. The VXI-1394 uses the onboard oscillator by default.

The VXI-1394 can also be configured to drive the external CLK SMB from the VXIbus CLK10 signal. Switch S2 controls whether the VXI-1394 drives or receives the external CLK SMB. If you change the S2 setting to drive CLK10 out the external CLK10 SMB connector, do not set switch S6 to receive the SMB CLK10 signal. Instead, use its default setting so that the onboard oscillator generates the signal.

You can use an additional switch, S3, to control the polarity of the external CLK SMB signal when S2 is configured to drive it. S3 is unused when S2 is configured to receive the external CLK SMB signal.

When switch S2 is set so that the VXI-1394 receives the SMB CLK10 signal, you have the option to add a 50 Ω termination to the signal by setting switch S1. S1 is unused when S2 is configured to drive the external CLK SMB signal.

Table C-1 summarizes the most common configuration types.

Table C-1. Common CLK10 Routing Configurations

Description	Switches			
	S1 Terminate	S2 Direction	S3 Polarity	S5 CLK10 Source
Generate internal CLK10 with onboard oscillator	N	IN	N/A	ONBRD
Generate internal CLK10 and drive to external CLK SMB	N/A	OUT	NON	ONBRD
Generate internal CLK10 and drive inverted to external CLK SMB	N/A	OUT	INV	ONBRD
Receive external CLK SMB and drive to the backplane unterminated	N	IN	N/A	SMB
Receive external CLK SMB with 50 Ω termination and drive to the backplane	Y	IN	N/A	SMB

Figure C-4 shows the default settings for the CLK10 switches. This configuration is as follows:

- CLK10 is generated from the onboard oscillator (S5).
- The CLK10 signal is not terminated (S1).
- The VXI-1394 receives the external CLK10 signal (S2).
- The polarity of the CLK10 signal (S3) is irrelevant when the VXI-1394 receives the external CLK10 signal. However, it is configured to be inverted when the CLK10 SMB is used as output.

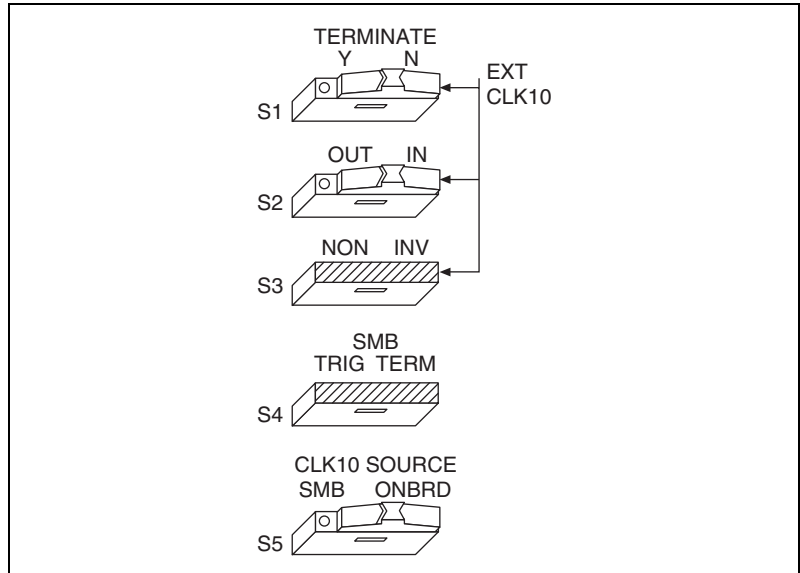

Figure C-4. Generate Internal CLK10 and Drive to the Backplane

In Figures C-5 and C-6, switch S5 uses the alternate configuration to generate the VXIbus CLK10 signal. Instead of the onboard oscillator, the VXI-1394 generates from the external CLK SMB connector and drives to the backplane. You can choose whether to terminate the signal using S1. Polarity remains irrelevant to these configurations.

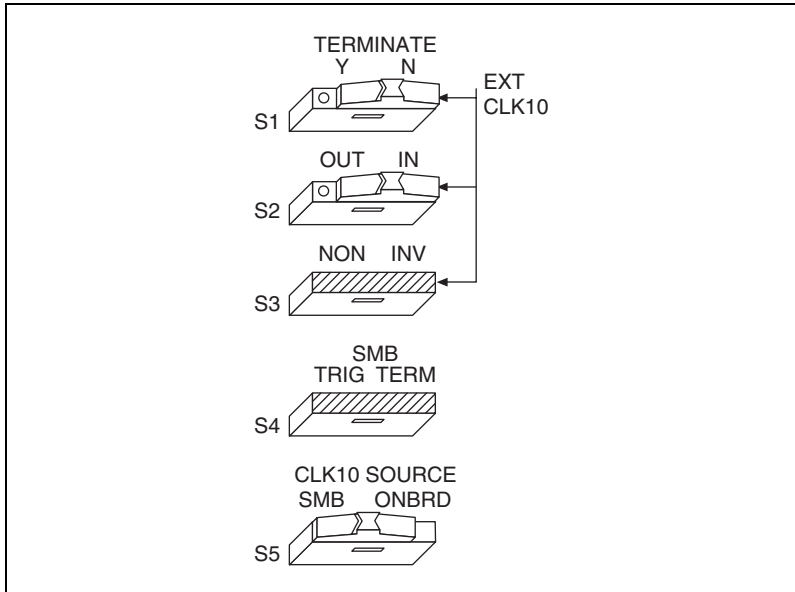

Figure C-5. Receive External CLK SMB and Drive to the Backplane Unterminated

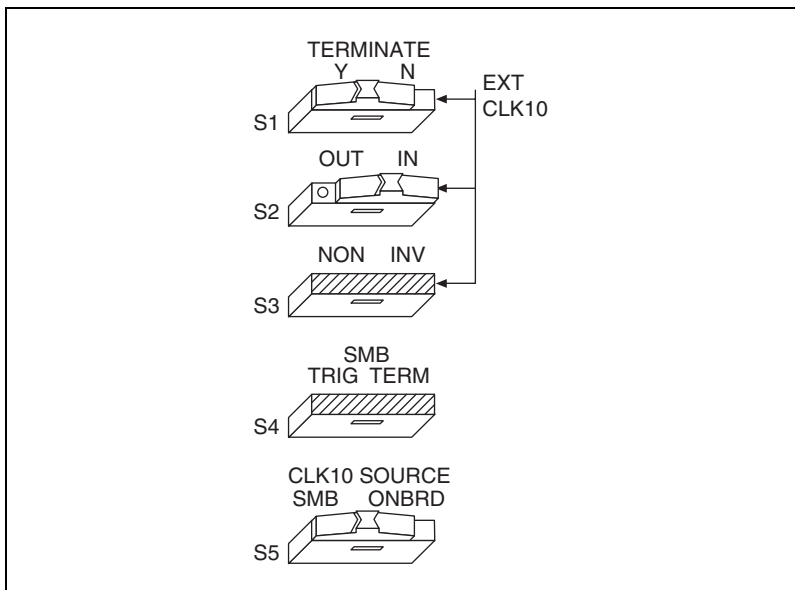

Figure C-6. Receive External CLK SMB with 50 Ω Termination and Drive to the Backplane

Figures C-7 and C-8 show two configurations for driving the external CLK SMB from the VXIbus CLK10 signal by changing switch S2 to its alternate setting. Switch S5 must be in its default position for these configurations. Signal termination is not an issue when driving the signal, so the position of S1 does not matter. The difference between these two configurations is whether to use inverted or noninverted polarity when driving the signal.

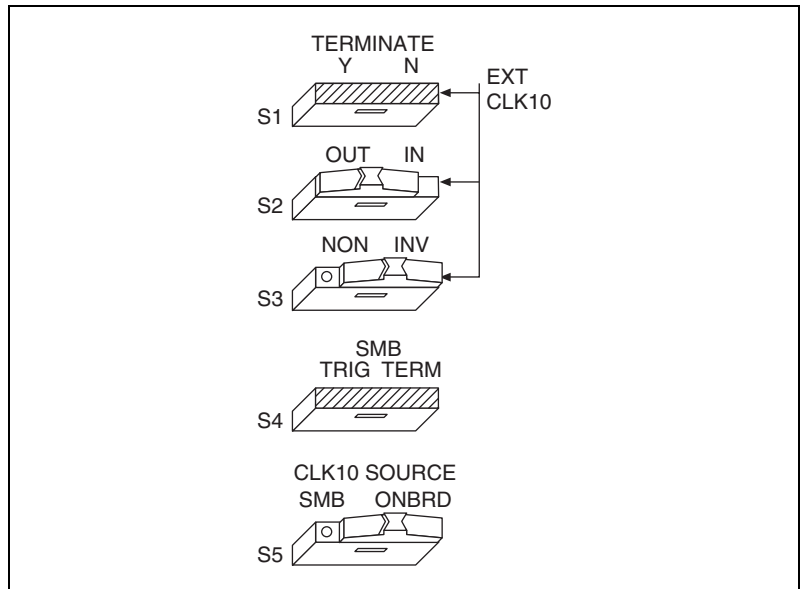

Figure C-7. Drive Inverted External CLK SMB

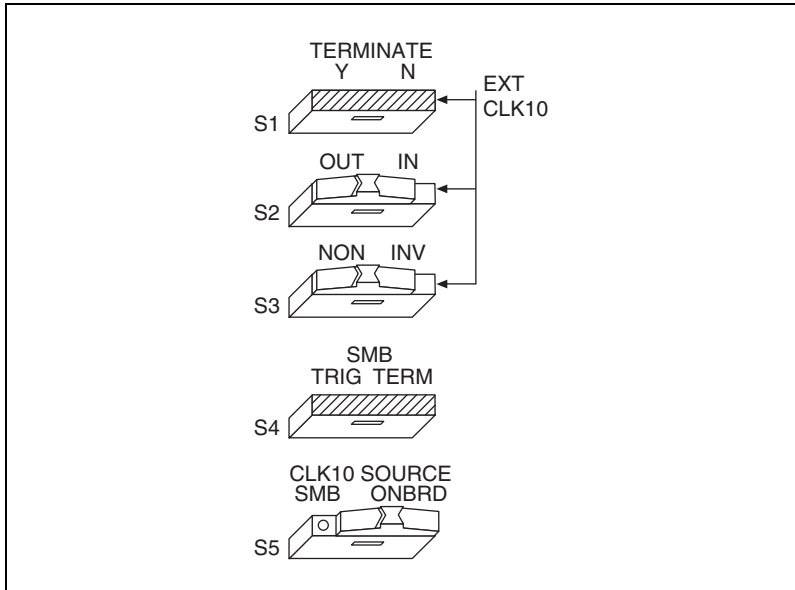

Figure C-8. Drive Noninverted External CLK SMB

Trigger Input Termination

Located within the group of CLK10 switches is switch S4, which controls whether to put a 50 Ω termination on the external trigger input SMB. Figure C-9A shows the default setting for a nonterminated trigger input SMB. Use the setting of Figure C-9B to terminate the trigger input SMB.

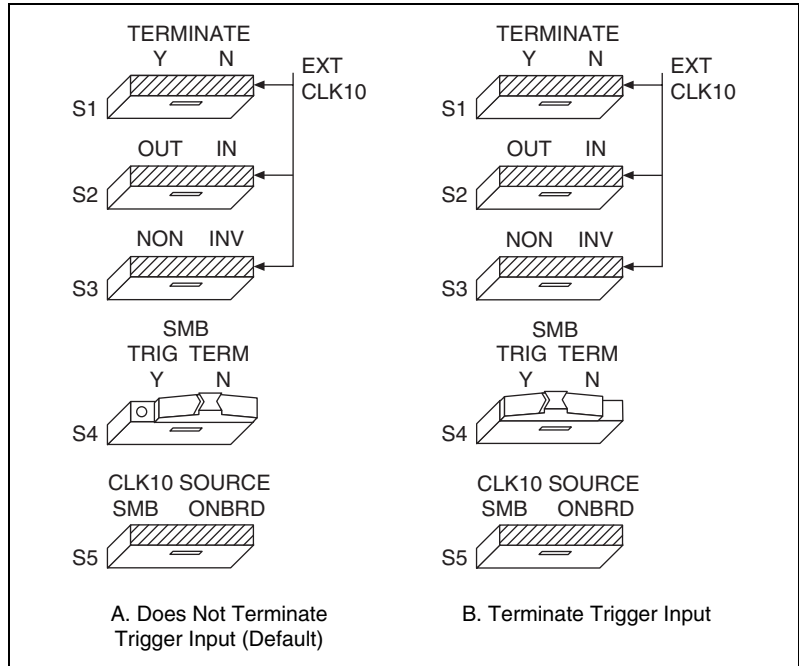

Figure C-9. SMB Trigger Input Termination

Common Questions

This appendix addresses common questions you may have about using the NI-VXI/NI-VISA software on the VXI-1394 platform.

What does *hot plugging* mean in terms of IEEE 1394?

The concept of hot plugging in 1394 means that you can remove and insert 1394 cables without powering down your computer and devices. The 1394 Plug and Play architecture is designed so that the host computer can recognize when to load and remove the appropriate drivers. However, notice that inserting or removing any 1394 cable results in an interrupt condition on all devices, which may adversely affect any applications using the VXI-1394 at that time. For that reason, NI recommends closing all 1394-related applications before changing your 1394 bus configuration, and running Resource Manager after adding any new 1394 devices to your system.

Does it matter whether I plug in a 1394 device to the PCI-1394 in my computer or to the VXI-1394 in my mainframe?

The only difference is the topology of the system. If your system consists of a PC connected to a VXI-1394 which is in turn connected to a digital camera, you can get the best performance by connecting a third peripheral to the VXI-1394 rather than to the PC or the digital camera. This restricts the maximum distance between any two nodes to two cable segments. Connecting the third peripheral to either the PC or the digital camera would create a maximum distance of three cable segments between any two nodes.

Use only a tree topology to build your system. A closed loop is illegal and will not work. For example, if you have a PCI-1394 and a VXI-1394 cabled together and you add direct connections from both of them to the same digital camera, you create a closed loop. A 1394 device should have only one connection to the 1394 system.

Can I have both a PCI-MXI-2 and a PCI-1394 interface in the same computer?

Yes.

I need more devices than can fit in one chassis. How can I expand my VXI-1394 system?

You can add another VXI-1394 to the system, but the additional chassis will not share the same VXI bus. The recommended strategy is to use a VXI-MXI-2, which follows the VXI-6 specification for mainframe extension. This extends full VXI functionality across multiple mainframes, including a common device address space and interframe triggering, interrupts, and bus mastering. Place a VXI-MXI-2 in the same frame as the Slot 0 VXI-1394, and another VXI-MXI-2 in Slot 0 of the next mainframe. You can then fill up this mainframe with additional devices.

How can I determine the serial number and hardware revision of the VXI-1394 board?

Run MAX and right-click the name of the VXI-1394 board. Select **Hardware Configuration**, and the dialog box for the VXI-1394 board is displayed. The title bar includes the serial number and hardware revision of the board.

What is Resman?

Resman is the name of the utility that performs the duties of a VXI Resource Manager as discussed in the VXIbus specification. When you set a National Instruments controller to Logical Address 0, you will at some point need to run Resman to configure your VXI instruments. If your controller uses a different (nonzero) logical address and is a message-based device, you need to start Resman before running it on the Logical Address 0 computer.

When do I need to run Resman?

Run Resman whenever you need to configure your VXI instruments. For example, if you power-cycle your VXI chassis, your instruments will be reset, and you will need to run Resman to configure them. You can get into trouble if you run Resman when your devices are not in a reset state. Therefore, if you have to run Resman after running it once, you should reset all your VXI instruments.

You can perform resource manager operations from within MAX after you install the VXI-1394 and cable it to your computer. With the VXI-1394, you may need to run the Resman utility if you boot your computer before turning on your VXI chassis or if you power-cycle your VXI chassis while the external PC remains on. In these cases, the instruments would have been reset without the computer rebooting. You will need to run the Resman utility or configure your system in MAX to initialize your VXI system.

Which NI-VXI utility program must I use to configure the VXI-1394?

Use MAX to configure the VXI-1394. MAX is in the **National Instruments** program group folder.

How do I handle VME devices?

Although there is no way to automatically detect VME devices in a system, you can add them easily through the **Add Device Wizard** in MAX. Through this procedure, you can reserve resources for each of your VME devices and configure MAX to show VME devices on the screen with all your other devices.

Which NI-VXI utility program must I use to perform startup Resource Manager operations?

Use the Resman program to perform startup Resource Manager operations in **Start»Programs»National Instruments»VXI**. Resman uses the settings configured in MAX. It initializes your VXI/VMEbus system and makes the information it collects accessible through MAX.

You can also run Resource Manager operations from MAX. Through MAX, you can also configure Resman to run automatically at startup.

What can I do to make sure that my system is up and running?

The fastest method for testing the system is to run Resman. This program attempts to access memory in the upper A16 address space of each device in the system. If Resman does not report any problems, the VXI-1394 communication system is operational.

To test individual devices, you can use the VIC or VISAIC program to interactively issue NI-VXI functions or NI-VISA operations, respectively. You can use `viIn()` and `viOut()` with the NI-VISA API (or `VXIin()` or `VXIinReg()` and `VXIout()` or `VXIoutReg()` with the NI-VXI API) to test register-based devices by programming their registers. If you have any message-based devices, you can send and receive messages with the `viRead()` and `viWrite()` operations in the NI-VISA API (or `WSrd()` and `WSwrt()` functions in the NI-VXI API). Notice that `VXIinReg()` and `VXIoutReg()` are for VXI devices only, but you can use `VXIin()` and `VXIout()` for both VXI and VME.

Finally, if you are using LabVIEW or LabWindows/CVI and you have instrument drivers for the devices in your chassis, you can use the interactive features of these programs to quickly test the functionality of the devices.

What should I do if I get a Configuration EEPROM is Invalid message?

There are several reasons why you might get the **Configuration EEPROM is Invalid** message. For example, if you turned off the VXI chassis while the configuration update process was still in progress, the board functions normally except when running MAX. To correct these problems, reboot the VXI chassis with the Load Factory switch set (as described in Appendix C, *Advanced Hardware Configuration Settings*) and update the configuration, or load the configuration from file.

What do the LEDs on the front of the VXI-1394 mean?

- The **SYSFAIL** LED shows the state of the VXI/VMEbus SYSFAIL line. This line is asserted whenever any device in the chassis has not yet passed its self test, if it has failed its self test, or if it has detected a failure after originally passing its self test.
- The **1394** LED indicates that the VXI-1394 is being accessed by another device on the IEEE 1394 bus, such as when the computer communicates with either the VXI-1394 or another device in the chassis.
- The **VXI** LED, when lit, indicates that the VXI-1394 is being accessed by another device in the VXI chassis, such as when a bus master inside the chassis wants to talk to either the VXI-1394 or memory in the computer.

What kind of signal is CLK10 and what kind of signal do I need for an external CLK10?

CLK10 is a differential ECL signal on the VXIbus backplane. However, the oscillator for the VXI-1394 and the EXTCLK input from the front panel use TTL. Therefore, supply a TTL-level signal for EXTCLK, and onboard voltage converters will automatically convert the signal to differential ECL.

What is the accuracy of the CLK10 signal?

The CLK10 generated by the VXI-1394 is 1% accurate. If you need a more accurate CLK10 signal, you can use the EXTCLK input at the front of the VXI-1394.

What is shared memory and dual-ported memory?

These terms refer to a block of memory that is accessible to both a client and a server. The memory block operates as a message buffer for communications. Shared memory is applicable only if you are using either A24 or A32 address space.

Technical Support and Professional Services

Visit the following sections of the National Instruments Web site at ni.com for technical support and professional services:

- **Support**—Online technical support resources include the following:
 - **Self-Help Resources**—For immediate answers and solutions, visit our extensive library of technical support resources available in English, Japanese, and Spanish at ni.com/support. These resources are available for most products at no cost to registered users and include software drivers and updates, a KnowledgeBase, product manuals, step-by-step troubleshooting wizards, conformity documentation, example code, tutorials and application notes, instrument drivers, discussion forums, a measurement glossary, and so on.
 - **Assisted Support Options**—Contact NI engineers and other measurement and automation professionals by visiting ni.com/support. Our online system helps you define your question and connects you to the experts by phone, discussion forum, or email.
- **Training**—Visit ni.com/training for self-paced tutorials, videos, and interactive CDs. You also can register for instructor-led, hands-on courses at locations around the world.
- **System Integration**—If you have time constraints, limited in-house technical resources, or other project challenges, NI Alliance Program members can help. To learn more, call your local NI office or visit ni.com/alliance.
- **Declaration of Conformity (DoC)**—A DoC is our claim of compliance with the Council of the European Communities using the manufacturer's declaration of conformity. This system affords the user protection for electronic compatibility (EMC) and product safety. You can obtain the DoC for your product by visiting ni.com/hardref.nsf.

- **Calibration Certificate**—If your product supports calibration, you can obtain the calibration certificate for your product at ni.com/calibration.

If you searched ni.com and could not find the answers you need, contact your local office or NI corporate headquarters. Phone numbers for our worldwide offices are listed at the front of this manual. You also can visit the Worldwide Offices section of ni.com/niglobal to access the branch office Web sites, which provide up-to-date contact information, support phone numbers, email addresses, and current events.

Glossary

Symbol	Prefix	Value
p	pico	10^{-12}
n	nano	10^{-9}
μ	micro	10^{-6}
m	milli	10^{-3}
k	kilo	10^3
M	mega	10^6
G	giga	10^9
T	tera	10^{12}

Symbols

° Degrees.

Ω Ohms.

A

A Amperes.

A16 space VXIbus address space equivalent to the VME 64 KB *short* address space. In VXI, the upper 16 KB of A16 space is allocated for use by VXI devices' configuration registers. This 16 KB region is referred to as VXI configuration space.

A24 space VXIbus address space equivalent to the VME 16 MB *standard* address space.

A32 space VXIbus address space equivalent to the VME 4 GB *extended* address space.

address Character code that identifies a specific location (or series of locations) in memory. In VISA, it identifies a resource.

address modifier	One of six signals in the VMEbus specification used by VMEbus masters to indicate the address space in which a data transfer is to take place.
address space	A set of 2^n memory locations differentiated from other such sets in VXI/VMEbus systems by six addressing lines known as address modifiers. n is the number of address lines required to uniquely specify a byte location in a given space. Valid numbers for n are 16, 24, and 32. In VME/VXI, because there are six address modifiers, there are 64 possible address spaces.
ANSI	American National Standards Institute
API	Application Programming Interface—the direct interface that an end user sees when creating an application.
arbitration	A process in which a potential bus master gains control over a particular bus.
asynchronous	Not synchronized; not controlled by time signals. In IEEE 1394, specifically, this is the standard protocol for sending packets that require an acknowledgment. This guarantees data delivery. The NI-VXI/NI-VISA drivers for 1394 use this protocol exclusively.
B	
b	Bit—one binary digit, either 0 or 1.
B	Byte—eight related bits of data, an 8-bit binary number. Also used to denote the amount of memory required to store one byte of data.
backplane	An assembly, typically a printed circuit board, with 96-pin connectors and signal paths that bus the connector pins. A C-size VXIbus system will have two sets of bused connectors called J1 and J2. A D-size VXIbus system will have three sets of bused connectors called J1, J2, and J3.
BERR*	Bus error signal.
BIOS	Basic Input/Output System. BIOS functions are the fundamental level of any PC or compatible computer. BIOS functions embody the basic operations needed for successful use of the computer's hardware resources.

block-mode transfer	An uninterrupted transfer of data elements in which the master sources only the first address at the beginning of the cycle. The slave is then responsible for incrementing the address on subsequent transfers so that the next element is transferred to or from the proper storage location. A VME data transfer may have no more than 256 elements.
bus	The group of conductors that interconnect individual circuitry in a computer. Typically, a bus is the expansion vehicle to which I/O or other devices are connected. Examples of buses include the ISA bus, PCI bus, VXI bus, and VME bus.
bus error	An error that signals failed access to an address. Bus errors occur with low-level accesses to memory and usually involve hardware with bus mapping capabilities. For example, nonexistent memory, a nonexistent register, or an incorrect device access can cause a bus error.
bus master	A device that is capable of requesting the Data Transfer Bus (DTB) for the purpose of accessing a slave device.
byte order	How bytes are arranged within a word or how words are arranged within a longword. Motorola ordering stores the most significant byte (MSB) or word first, followed by the least significant byte (LSB) or word. Intel ordering stores the LSB or word first, followed by the MSB or word.

C

C	Celsius.
CLK10	A 10 MHz, ± 100 ppm, individually buffered (to each module slot), differential ECL system clock that is sourced from Slot 0 of a VXIbus mainframe and distributed to Slots 1 through 12 on P2. It is distributed to each slot as a single-source, single-destination signal with a matched delay of under 8 ns.
CMOS	Complementary Metal Oxide Semiconductor—a process used in making chips.

Commander	A message-based device that is also a bus master and can control one or more Servants.
configuration registers	A set of registers through which the system can identify a module device type, model, manufacturer, address space, and memory requirements. To support automatic system and memory configuration, the VXI specification requires that all VXIbus devices have a set of such registers.

D

Data Transfer Bus	DTB; one of four buses on the VMEbus backplane. The DTB is used by a bus master to transfer binary data between itself and a slave device.
DMA	Direct Memory Access—a method by which data is transferred between devices and internal memory without intervention of the central processing unit. DMA is the fastest method of transferring data to/from computer memory.
DRAM	Dynamic RAM (Random Access Memory)—storage that the computer must refresh at frequent intervals.
dynamic configuration	A method of automatically assigning logical addresses to VXIbus devices at system startup or other configuration times.
dynamically configured device	A device that has its logical address assigned by the Resource Manager. A VXI device initially responds at Logical Address 255 when its MODID line is asserted. The Resource Manager subsequently assigns it a new logical address, to which the device responds until powered down.

E

ECL	Emitter-Coupled Logic.
EEPROM	Electrically Erasable Programmable Read Only Memory—ROM that can be erased with an electrical signal and reprogrammed.
embedded controller	An intelligent CPU (controller) interface plugged directly into the VXI backplane, giving it direct access to the VXIbus. It must have all of its required VXI interface capabilities built in.
EMC	Electromagnetic compliance.

EMI Electromagnetic interference.

external trigger A voltage pulse from an external source that triggers an event.

F

fair requester A VXIbus device that will not arbitrate for the VXIbus after releasing it until it detects the bus request signal inactive. This ensures that all requesting devices will be granted use of the bus.

FireWire An Apple trademark for the technology that came to be defined as IEEE 1394. *See* IEEE 1394.

G

g (1) Grams.
(2) A measure of acceleration equal to 9.8 m/s².

g_{RMS} A measure of random vibration. The root mean square of acceleration levels in a random vibration test profile.

H

hex Hexadecimal—the numbering system with base 16, using the digits 0 to 9 and letters A to F.

hot plug-in capability The ability, a feature in IEEE 1394, to add and remove devices to a computer while the computer is running and have the operating system automatically recognize the change.

Hz Hertz; cycles per second.

I

i.LINK A brand name initiated by Sony for digital consumer products using IEEE 1394. *See* IEEE 1394.

I/O Input/output—the techniques, media, and devices used to achieve communication between machines and users.

IDE	Integrated Drive Electronics. Denotes the most common interface to the hard drive on PCs.
IEC	International Electrotechnical Commission. The IEC publishes internationally recognized standards. IEC 60068 contains information on environmental testing procedures and severities.
IEEE	Institute of Electrical and Electronics Engineers.
IEEE 1394	A cross-platform implementation of the high-speed serial data bus, defined by IEEE Standard 1394-1995, that can move large amounts of data between computers and peripheral devices. It features simplified cabling, hot swapping, and transfer speeds of up to 400 Mbits/s. IEEE 1394 also enables the connection of digital consumer products, including digital camcorders, digital video tapes, digital video disks, set-top boxes, and music systems, directly to a personal computer.
in.	Inches.
instrument driver	A set of routines designed to control a specific instrument or family of instruments, and any necessary related files for LabWindows/CVI or LabVIEW.
interrupt	A means for a device to request service from another device; a computer signal indicating that the CPU should suspend its current task to service a designated activity.
interrupt handler	A VMEbus functional module that detects interrupt requests generated by interrupters and responds to those requests by requesting status and identify information.
interrupt level	The relative priority at which a device can interrupt.
IRQ*	Interrupt signal.
isochronous	Pertains to processes that require timing coordination to be successful, such as voice and digital video transmission. A sound or picture going from a peripheral computer device or across a network into a computer or television set needs to arrive at close to the same rate of data flow as the source. In IEEE 1394, this protocol is used for purposes such as feeding digital image data from a peripheral device (such as a video camera) to a display mechanism within a computer.

K

K Kilo—(1) the standard metric prefix for 1,000, or 10^3 , used with units of measure such as volts, hertz, and meters; (2) the prefix for 1,024, or 2^{10} , used with B (byte) in quantifying data or computer memory.

L

logical address An 8-bit number that uniquely identifies each VXIbus device in a system. It defines the A16 register address of a device, and indicates Commander and Servant relationships.

M

m Meters.

M Mega—(1) the standard metric prefix for 1 million or 10^6 , when used with units of measure such as volts and hertz; (2) the prefix for 1,048,576, or 2^{20} , when used with B (byte) to quantify data or computer memory.

master A functional part of a VME/VXIbus device that initiates data transfers on the backplane. A transfer can be either a read or a write.

message-based device An intelligent device that implements the defined VXIbus registers and communication protocols. These devices are able to use Word Serial Protocol to communicate with one another through communication registers.

MODID Module ID lines—used in VXI to geographically locate boards and to dynamically configure boards.

MTBF Mean Time Between Failure.

N

NI-DAQ The National Instruments industry-standard software for data acquisition instruments.

NI-VISA The National Instruments implementation of the VISA standard; an interface-independent software that provides a unified programming interface for VXI, GPIB, and serial instruments.

- NI-VXI The National Instruments bus interface software for VME/VXIbus systems.
- Non-Slot 0 device A device configured for installation in any slot in a VXIbus mainframe other than Slot 0. Installing such a device into Slot 0 can damage the device, the VXIbus backplane, or both.

O

- OHCI Open Host Controller Interface. Specification for the register set for a 1394 controller card. This standard allows interoperability of software with controllers from different vendors.

P

- PCI Peripheral Component Interconnect. The PCI bus is a high-performance 32-bit or 64-bit bus with multiplexed address and data lines.

R

- register-based device A Servant-only device that supports VXIbus configuration registers. Register-based devices are typically controlled by message-based devices via device-dependent register reads and writes.
- Resman The name of the National Instruments Resource Manager in NI-VXI bus interface software. *See* Resource Manager.
- Resource Manager A message-based Commander located at Logical Address 0, which provides configuration management services such as address map configuration, Commander and Servant mappings, and self-test and diagnostic management.
- retry An acknowledge by a destination that signifies that the cycle did not complete and should be repeated.
- RMS Root mean squared. *See* g_{RMS} .

S

s	Seconds.
SIMM	Single In-line Memory Module.
slave	A functional part of a VME/VXIbus device that detects data transfer cycles initiated by a VMEbus master and responds to the transfers when the address specifies one of the device's registers.
Slot 0 device	A device configured for installation in Slot 0 of a VXIbus mainframe. This device is unique in the VXIbus system in that it performs the VXI/VMEbus System Controller functions, including clock sourcing and arbitration for data transfers across the backplane. Installing such a device into any other slot can damage the device, the VXIbus backplane, or both.
SMB	Sub Miniature Type B connector that features a snap coupling for fast connection.
statically configured device	A device whose logical address cannot be set through software; that is, it is not dynamically configurable.
streaming data	Data that is structured and processed in a continuous flow, such as digital audio and video. In IEEE 1394, this is often sent with the isochronous protocol rather than the standard asynchronous protocol.
SYSFAIL	A VMEbus signal that is used by a device to indicate an internal failure. A failed device asserts this line. In VXI, a device that fails also clears its PASSEd bit in its Status register.

T

trigger	Either TTL or ECL lines used for intermodule communication.
TTL	Transistor-Transistor Logic

V

V	Volts.
VGA	Video Graphics Array; the minimum video display standard for all PCs.

VIC	VXI Interactive Control program, a part of the NI-VXI bus interface software. Used to program VXI devices and develop and debug VXI application programs.
VISA	Virtual Instrument Software Architecture. This is the general name given to VISA and its associated architecture.
VISAIC	VISA Interactive Control program, a part of the NI-VISA software. Used to program devices and develop and debug application programs.
VITA	VMEbus International Trade Association.
VME	Versa Module Eurocard or IEEE 1014.
VMEbus System Controller	A device configured for installation in Slot 0 or a VXIbus mainframe or the first slot in a VMEbus chassis. This device is unique in the VMEbus system in that it performs the VMEbus System Controller functions, including clock sourcing and arbitration for data transfers across the backplane. Installing such a device into any other slot can damage the device, the VMEbus/VXIbus backplane, or both.
VXIbus	VMEbus Extensions for Instrumentation.

W

W	Watts.
Word Serial Protocol	The simplest required communication protocol supported by message-based devices in a VXIbus system. It utilizes the A16 communication registers to transfer data using a simple polling handshake method.
write posting	A mechanism that signifies that a device will immediately give a successful acknowledge to a write transfer and place the transfer in a local buffer. The device can then independently complete the write cycle to the destination.

Index

Numerics

1394 6-pin connectors, 1-3
1394 LED, 1-3

A

advanced hardware configuration settings, C-1
application development, 3-1
application software, 1-4

C

cable your system (caution), 2-6
calibration certificate (NI resources), E-2
capability codes, VMEbus, A-3
capability descriptions, IEEE 1394, A-2
CLK switches
 generate internal CLK10 and drive to the backplane (figure), C-7
CLK10
 routing, VXI bus, C-5
 signal accuracy, D-4
 signal type, D-4
common CLK10 routing configurations (table), C-6
common questions, D-1
 Configuration EEPROM is Invalid message, D-4
 hot plug-in
 and IEEE 1394, D-1
 LEDs, definitions of, D-4
 NI-VXI utility programs, D-3
 PCI-MXI-2 and PCI-1394 interfaces in the same computer, D-1
 plugging in multiple peripherals, D-1
 Resman, D-2
 using, D-3

 serial number and hardware revision of VXI-1394, D-2
 shared memory and dual-ported memory, D-4
 VME devices, D-3
 VXI-1394 system expansion, D-2
compatibility layer options, 3-9
compiler symbols, 3-8
configuration, 2-1, 3-2
 advanced hardware settings, C-1
 advanced options, 1-3, C-1
 default settings, B-1
 EEPROM, C-4
 hardware, 2-3
 setup, 2-1
 VXI-1394 default configuration settings (figure), C-2
 VXIbus slot configuration (figure), C-3
Configuration EEPROM is Invalid message, D-4
connectors, 1394 6-pin, 1-3
controller
 selecting in VISAIC (figure), 3-4
conventions used in the manual, *viii*
customer
 professional services, E-1
 technical support, E-1

D

debugging, 3-10
Declaration of Conformity (NI resources), E-1
default settings
 hardware, 2-3, B-1
 software, B-2
developing applications, 3-1
device interaction, 3-3
device tab default settings (table), B-2

diagnostic tools (NI resources), E-1

documentation

conventions used in manual, *viii*

how to use manual set, *vii*

related documentation, *ix*

drivers (NI resources), E-1

E

EEPROM

configuration, C-4

Configuration EEPROM is Invalid
message, D-4

operation (figure), C-4

electrostatic discharge (caution), 2-3

example programs (table), 3-7

examples (NI resources), E-1

F

front panel

features, 1-3

LEDs, definitions of, D-4

G

getting started, what you need, 1-1

H

hardware

advanced configuration settings, C-1

default settings, B-1, C-1

description, 1-2

installing, 2-3

PCI-1394, 1-3

hardware configuration, 3-2

help

professional services, E-1

technical support, E-1

hot plug-in

and IEEE 1394, D-1

definition of, 1-1

how to use manual set, *vii*

I

IEEE 1394, capability descriptions, A-2

installation, 2-1

instrument drivers (NI resources), E-1

K

KnowledgeBase, E-1

L

LabVIEW, 1-5

LabWindows/CVI, 1-5

LEDs

1394, 1-3

definitions of, D-4

SYSFAIL, 1-3

VXI, 1-3

M

MAX, 2-7

device tab default settings (table), B-2

overview, 1-4

shared memory tab default settings
(table), B-2

VXI bus tab default settings (table), B-3

Measurement and Automation Explorer.

See MAX

Measurement Studio, 1-5

multiple devices, connecting (caution), 1-2

N

National Instruments
 professional services, E-1
 technical support, E-1
 National Instruments application software, 1-4
 LabVIEW, 1-4
 LabWindows/CVI, 1-4
 National Instruments support and services, E-1
 NI Spy (figure), 3-10
 NI Spy utility, 1-4
 NI support and services, E-1
 NI-VISA
 definition, 3-1
 installing, 2-1
 NI-VISA/NI-VXI software
 example programs (table), 3-7
 NI-VXI
 definition, 3-1
 installing, 2-1
 NI-VXI API
 compatibility layer options, 3-9
 compiler symbols, 3-8
 definition, 3-1
 NI-VXI compatibility layer, 3-1

O

OHCI host adapter, 1-1
 online technical support, E-1
 overview, VXI-1394 kit, 1-2

P

PCI-1394, 1-3
 host adapter, installing, 2-5
 interface board, installing, 2-4
 professional services, E-1
 programming examples (NI resources), E-1
 programming for VXI, 3-6

NI-VXI API, 3-8
 optimizing large VXIbus transfers, 3-7
 shared memory, 3-8

R

related documentation, *ix*
 Resman, 2-7, D-2
 running from MAX (figure), 3-3
 using, D-3
 restart system power, 2-7

S

setup, 2-1
 shared memory, 3-8
 shared memory tab default settings
 (table), B-2
 slot 0/non-slot 0, C-2
 slot configuration, VXI bus (figure), C-3
 software
 description, 1-4
 installation, 2-1
 software (NI resources), E-1
 specifications
 environmental, A-1
 physical, A-2
 power requirement, A-1
 requirements, A-1
 support, technical, E-1
 SYSFAIL LED, 1-3
 system controller, 2-6

T

technical support, E-1
 training (NI resources), E-1
 troubleshooting (NI resources), E-1

U

user-configurable settings, C-1

V

viIn access in VISAIC (figure), 3-5
VISAIC, selecting a controller in (figure), 3-4
VISAIC (figure), 3-11
VMEbus capability codes, A-3
VXI, programming, 3-6
VXI bus tab default settings (table), B-3
VXI LED, 1-3
VXI-1394
 default configuration settings
 (figure), C-2
 front panel features, 1-3
 hardware default settings (table), B-1

interface board, installing, 2-5
interface kit overview, 1-2
module description, 1-2
specifications, A-1
system expansion, D-2
typical system setup (figure), 2-4

VXIbus

CLK10 routing, C-5
slot 0/non-slot 0, C-2
slot configuration (figure), C-3

VXIbus transfers, optimizing, 3-7

W

Web

professional services, E-1
technical support, E-1