

CALIBRATION PROCEDURE

SCXI™-1100

This document contains step-by-step instructions for verifying the performance of National Instruments SCXI-1100 modules.

Equipment and Other Test Requirements

This section describes the equipment, software, documentation, and test conditions required for verifying the performance of the SCXI-1100.

Test Equipment

Verification requires a high-precision voltage source with at least 50 ppm accuracy and an E Series data acquisition (DAQ) device.

NI recommends you use the following instruments for verifying the performance of the SCXI-1100:

- Calibrator—Fluke 5700A
- National Instruments E Series DAQ device

If these instruments are not available, use the accuracy requirements listed above to select a substitute calibration standard.



Notes If you do not have custom connection hardware, you need a connector block such as the National Instruments SCXI-1300, a shielded 68-pin connector cable, and an SCXI-1349 adapter. These components give easy access to the individual pins on the SCXI-1100 front and rear connectors.

Do not use an SCXI-1308 terminal block as the current sensing resistors causes false failures.

Software and Documentation

This section describes the software and documentation required for verifying the performance of the SCXI-1100 module.

Software

The only software required for this verification procedure is the current version of NI-DAQ, which contains the required calibration functions.

Documentation

This calibration document contains all the information you need to complete the verification procedure. If you want more information about the product, refer to the *SCXI-1100 User Manual*, which you can download from ni.com/manuals. If you need more information about the calibration functions, refer to the *NI-DAQ Function Reference Help*, which you can find by selecting **Start»Programs»National Instruments»NI-DAQ»NI-DAQ Help»NI-DAQ Function Reference Help**.

Test Conditions

Follow these guidelines to optimize the connection and the environment during verification.

- Keep connections to the SCXI module as short as possible. Long cables and wires act as antennae, picking up extra noise that can affect measurements.
- Use shielded copper wire for all cable connections to the module. Use twisted-pair wire to eliminate noise and thermal offsets.
- Maintain temperature between 18 and 28 °C.
- Keep relative humidity below 80%.
- Allow a warm-up time of at least 15 minutes for the SCXI module and 30 minutes for the E Series DAQ device to ensure the measurement circuitry is at a stable operating temperature.

Verification Procedures

The SCXI-1100 does not maintain user-adjustable calibration constants, so you can only verify the performance of the module.

Setting Up the Module

Complete the following steps to set up the SCXI-1100 for testing.

1. Install the SCXI-1100 in slot 1 of the SCXI chassis.
2. Using an SCXI-1349 cable adapter, connect a 68-to-68-pin cable between the SCXI-1100 module and the E Series DAQ device installed in the host computer, as shown in Figure 1.

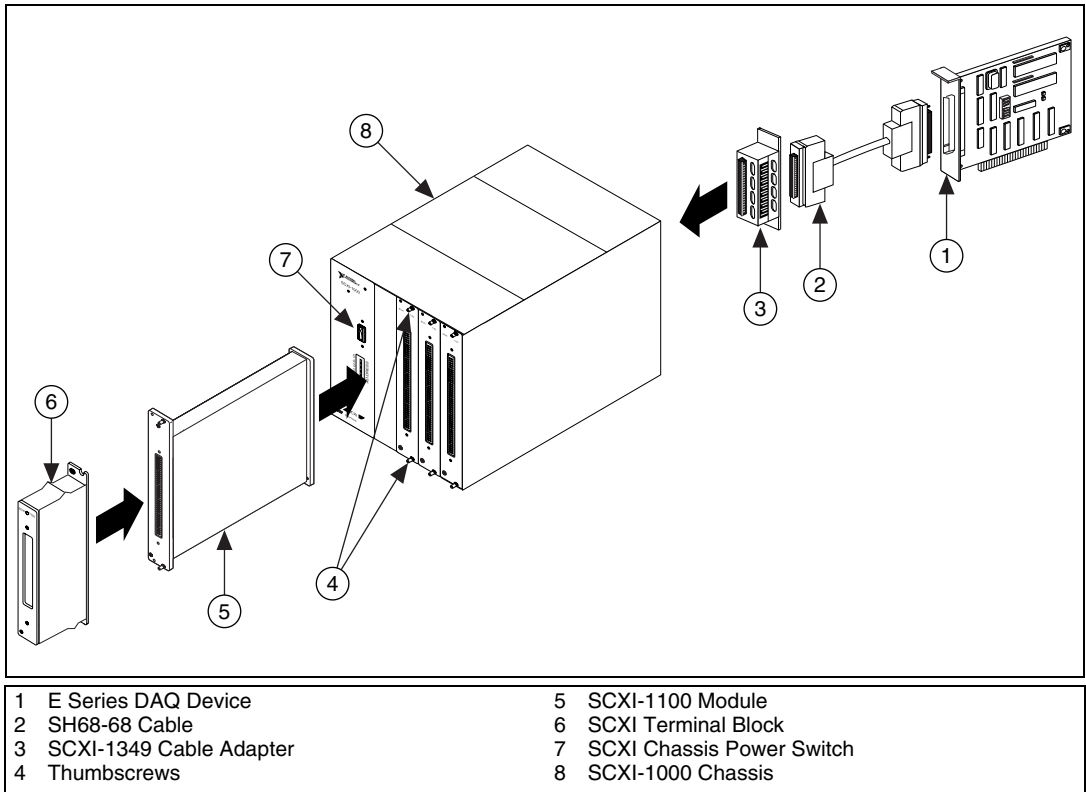



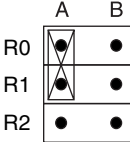
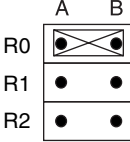
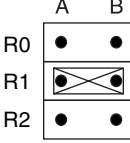
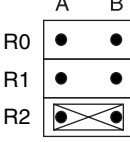

Figure 1. Connecting an SCXI Chassis to an E Series DAQ Device



- Configure the hardware with Measurement & Automation Explorer (MAX). If you need more information on configuring the system, refer to the E Series DAQ device and SCXI-1100 documentation, which is available at ni.com/manuals.
- Set all jumpers to their factory-default settings, as shown in Table 1.

Table 1. Factory-Default Jumper Settings

Jumper	Description	Configuration
W1	Factory setting; parking position (used for ground-referenced sources)	
W5	Factory setting; connects MISO to SERDATOUT	
W6	Factory setting; do not remove this jumper	
W7	Factory setting; parking position. Disconnects the front connector from the module output	
W8	Factory setting; parking position	
W9	Factory setting; connects pull-up resistor to SERDATOUT (revision C and later modules only)	
W10	Factory setting; parking position (used with E Series devices in differential mode)	
W11	Factory setting (revisions A and B only)	

The SCXI-1100 module has jumpers that you can use to change the filter settings, as shown in Table 2. During the verification procedure, you need to change the filter settings to verify both the 4 Hz and 10 kHz measurement accuracies. You can change the filter settings without powering off the SCXI chassis.

Table 2. Jumper Filter Settings

Jumper	Description	Configuration
W2	Factory setting is full bandwidth (FBW) and no filtering	
W3	10 kHz lowpass filter	
W4	4 Hz lowpass filter	

Verifying the Performance of the Module

The verification procedure determines how well the SCXI-1100 module is meeting its specifications. You can use this information to select the appropriate calibration interval for your application.



Note All calibration functions are contained in `niDAQ32.dll`. For more information on these functions, refer to the *NI-DAQ Function Reference Help*, which is available at ni.com/manuals.

Complete the following steps to verify the performance of the SCXI-1100.

1. Read the *Test Conditions* section.
2. Refer to the *Uncalibrated Offset Limit* and Table 4 for the specification limits to test. NI recommends that you verify all ranges and gains, but you can save time by checking only those ranges used in your application. Channel 0 is the only channel requiring verification because the SCXI-1100 module only contains one instrumentation amplifier.
3. Ensure that the E Series DAQ device is connected to the SCXI-1100.



Note NI recommends that you calibrate only the module that is connected to the E Series DAQ device. Do not calibrate the module in multiplexed mode.

4. Call `Calibrate_E_Series` to minimize the uncertainty associated with the E Series DAQ device. Set the following parameters:
 - **deviceNumber** = The device number assigned by MAX
 - **calOp** = `ND_SELF_CALIBRATE` (32700)
 - **setOfCalConst** = `ND_USER_EEPROM_AREA` (37000)
 - **calRefVolts** = 0.0
5. Call `MIO_Config` to enable dithering on the E Series DAQ device measurements. Set the following parameters:
 - **deviceNumber** = The device number assigned by MAX
 - **dither** = 1
 - **useAMUX** = 0
6. Configure the module jumpers for the 4 Hz filter, as shown in Table 2.
7. Call `SCXI_Calibrate_Setup`. Set the following parameters:
 - **chassisID** = The value assigned by MAX
 - **moduleSlot** = 1
 - **calOp** = 1
8. Call `SCXI_Single_Chan_Setup` to configure the module for single channel measurements. Set the following parameters:
 - **chassisID** = The value assigned by MAX
 - **moduleSlot** = 1
 - **moduleChan** = 0
 - **DAQdeviceNumber** = The device number for the E Series DAQ device, which is assigned by MAX
9. Call `SCXI_Set_Gain` to configure the module to the gain value you are testing. Set the following parameters:
 - **chassisID** = The value assigned by MAX
 - **moduleSlot** = 1
 - **moduleChan** = -1
 - **gain** = The gain value you are testing from Table 4
10. Wait 30 seconds for the input to settle.

11. Call `DAQ_Op`. Set the following parameters:
 - **deviceNumber** = The device number assigned by MAX
 - **channel** = 0
 - **gain** = 1 for a 16-bit E Series DAQ device or -1 for a 12-bit E Series DAQ device
 - **count** = 100
 - **sampleRate** = 100
12. Call `SCXI_Scale` to convert the reading from binary to voltage. Set the following parameters:
 - **chassisID** = The value assigned by MAX
 - **moduleSlot** = 1
 - **channel** = 0
 - **SCXIgain** = The gain you are testing
 - **TBgain** = 1
 - **DAQboard** = The device number for the E Series DAQ device
 - **DAQChannel** = 0
 - **DAQgain** = 1
 - **numPoints** = 100
 - **binArray** = The array returned from the `DAQ_Op`

Average the results and compare this value to the offset limits in the [Uncalibrated Offset Limit](#) section.
13. Configure the module jumpers for the filter you are testing, as shown in Tables 1 and 2.
14. Call `SCXI_Calibrate_Setup`. Set the following parameters:
 - **chassisID** = The value assigned by MAX
 - **moduleSlot** = 1
 - **calOp** = 1
15. Call `SCXI_Single_Chan_Setup` to configure the module for single channel measurements. Set the following parameters:
 - **chassisID** = The value assigned by MAX
 - **moduleSlot** = 1
 - **moduleChan** = 0
 - **DAQdeviceNumber** = The device number for the E Series DAQ device, which is assigned by MAX

16. Call `SCXI_Set_Gain` to configure the module to the gain value you are testing. Set the following parameters:
 - **chassisID** = The value assigned by MAX
 - **moduleSlot** = 1
 - **moduleChan** = -1
 - **gain** = The gain value you are testing from Table 4
17. Wait for input to settle (1 s if you are testing the 4 Hz filter, 10 ms if you are testing the 10 kHz filter).
18. Call `DAQ_Op`. Set the following parameters:
 - **deviceNumber** = The device number assigned by MAX
 - **channel** = 0
 - **gain** = 1 for a 16-bit E Series DAQ device or -1 for a 12-bit E Series DAQ device
 - **count** = 100
 - **sampleRate** = 100
19. Call `SCXI_Scale` to convert the reading from binary to voltage. Set the following parameters:
 - **chassisID** = The value assigned by MAX
 - **moduleSlot** = 1
 - **channel** = 0
 - **SCXIgain** = The gain you are testing
 - **TBgain** = 1
 - **DAQboard** = The device number for the E Series DAQ device
 - **DAQChannel** = 0
 - **DAQgain** = 1
 - **numPoints** = 100
 - **binArray** = The array returned from the `DAQ_Op`

Average the results and save the average for later calculations. This value is the zero offset that you subtract from subsequent measurements.
20. Call `SCXI_Calibrate_Setup`. Set the following parameters:
 - **chassisID** = The value assigned by MAX
 - **moduleSlot** = 1
 - **calOp** = 0

21. Call `SCXI_Single_Chan_Setup` to configure the module for single channel measurements. Set the following parameters:
 - **chassisID** = The value assigned by MAX
 - **moduleSlot** = 1
 - **moduleChan** = 0
 - **DAQdeviceNumber** = The device number for the E Series DAQ device, which is assigned by MAX
22. Call `SCXI_Set_Gain` to configure the module to the gain value you are testing. Set the following parameters:
 - **chassisID** = The value assigned by MAX
 - **moduleSlot** = 1
 - **moduleChan** = -1
 - **gain** = The gain value you are testing from Table 4
23. Input the test voltage listed in Table 4 into Channel 0 of the SCXI-1100 module.
24. Wait for input to settle (1 s if you are testing the 4 Hz filter, 10 ms if you are testing the 10 kHz filter).
25. Call `DAQ_Op`. Set the following parameters:
 - **deviceNumber** = The device number assigned by MAX
 - **channel** = 0
 - **gain** = 1 for a 16-bit E Series DAQ device or -1 for a 12-bit E Series DAQ device
 - **count** = 100
 - **sampleRate** = 100
26. Call `SCXI_Scale` to convert the reading from binary to voltage. Set the following parameters:
 - **chassisID** = The value assigned by MAX
 - **moduleSlot** = 1
 - **channel** = 0
 - **SCXIgain** = The gain you are testing
 - **TBgain** = 1
 - **DAQboard** = The device number for the E Series DAQ device
 - **DAQChannel** = 0
 - **DAQgain** = 1

- **numPoints** = 100
- **binArray** = The array returned from the DAQ_Op

The result is a set of scaled voltages you read from the SCXI-1100 module.

27. Average the results returned from the `SCXI_Scale`. Subtract the zero offset that you calculated in step 12 from this averaged value. Compare the result to the upper and lower limits in Table 4.
28. Repeat steps 14 through 27 for the remaining test points and gains.
29. Repeat steps 6 through 28 for the remaining filter settings.

You have finished verifying the performance of the SCXI-1100 module. If the module fails to meet its required specifications, contact NI for repair or replacement.

Front and Rear Connector Pin Assignments

Table 3 shows the pin assignments for the SCXI-1100 module front signal connector. Figure 2 shows the pin assignments for the SCXI-1100 rear signal connector.

Table 3. Front Signal Pin Assignments

Front Connector Diagram				Pin Number	Column A	Column B	Column C																																																																																																																																
<div style="display: flex; align-items: center; justify-content: center;"> <div style="text-align: center; margin-right: 10px;"> Column A B C </div> <table border="1" style="border-collapse: collapse; text-align: center;"> <tr><td>32</td><td>○</td><td>○</td><td>○</td></tr> <tr><td>31</td><td>○</td><td>○</td><td>○</td></tr> <tr><td>30</td><td>○</td><td>○</td><td>○</td></tr> <tr><td>29</td><td>○</td><td>○</td><td>○</td></tr> <tr><td>28</td><td>○</td><td>○</td><td>○</td></tr> <tr><td>27</td><td>○</td><td>○</td><td>○</td></tr> <tr><td>26</td><td>○</td><td>○</td><td>○</td></tr> <tr><td>25</td><td>○</td><td>○</td><td>○</td></tr> <tr><td>24</td><td>○</td><td>○</td><td>○</td></tr> <tr><td>23</td><td>○</td><td>○</td><td>○</td></tr> <tr><td>22</td><td>○</td><td>○</td><td>○</td></tr> <tr><td>21</td><td>○</td><td>○</td><td>○</td></tr> <tr><td>20</td><td>○</td><td>○</td><td>○</td></tr> <tr><td>19</td><td>○</td><td>○</td><td>○</td></tr> <tr><td>18</td><td>○</td><td>○</td><td>○</td></tr> <tr><td>17</td><td>○</td><td>○</td><td>○</td></tr> <tr><td>16</td><td>○</td><td>○</td><td>○</td></tr> <tr><td>15</td><td>○</td><td>○</td><td>○</td></tr> <tr><td>14</td><td>○</td><td>○</td><td>○</td></tr> <tr><td>13</td><td>○</td><td>○</td><td>○</td></tr> <tr><td>12</td><td>○</td><td>○</td><td>○</td></tr> <tr><td>11</td><td>○</td><td>○</td><td>○</td></tr> <tr><td>10</td><td>○</td><td>○</td><td>○</td></tr> <tr><td>9</td><td>○</td><td>○</td><td>○</td></tr> <tr><td>8</td><td>○</td><td>○</td><td>○</td></tr> <tr><td>7</td><td>○</td><td>○</td><td>○</td></tr> <tr><td>6</td><td>○</td><td>○</td><td>○</td></tr> <tr><td>5</td><td>○</td><td>○</td><td>○</td></tr> <tr><td>4</td><td>○</td><td>○</td><td>○</td></tr> <tr><td>3</td><td>○</td><td>○</td><td>○</td></tr> <tr><td>2</td><td>○</td><td>○</td><td>○</td></tr> <tr><td>1</td><td>○</td><td>○</td><td>○</td></tr> </table> </div>				32	○	○	○	31	○	○	○	30	○	○	○	29	○	○	○	28	○	○	○	27	○	○	○	26	○	○	○	25	○	○	○	24	○	○	○	23	○	○	○	22	○	○	○	21	○	○	○	20	○	○	○	19	○	○	○	18	○	○	○	17	○	○	○	16	○	○	○	15	○	○	○	14	○	○	○	13	○	○	○	12	○	○	○	11	○	○	○	10	○	○	○	9	○	○	○	8	○	○	○	7	○	○	○	6	○	○	○	5	○	○	○	4	○	○	○	3	○	○	○	2	○	○	○	1	○	○	○	32	CGND	CH0-	CH0+
				32	○	○	○																																																																																																																																
				31	○	○	○																																																																																																																																
				30	○	○	○																																																																																																																																
				29	○	○	○																																																																																																																																
				28	○	○	○																																																																																																																																
				27	○	○	○																																																																																																																																
				26	○	○	○																																																																																																																																
				25	○	○	○																																																																																																																																
				24	○	○	○																																																																																																																																
				23	○	○	○																																																																																																																																
				22	○	○	○																																																																																																																																
				21	○	○	○																																																																																																																																
				20	○	○	○																																																																																																																																
				19	○	○	○																																																																																																																																
				18	○	○	○																																																																																																																																
				17	○	○	○																																																																																																																																
				16	○	○	○																																																																																																																																
				15	○	○	○																																																																																																																																
				14	○	○	○																																																																																																																																
				13	○	○	○																																																																																																																																
				12	○	○	○																																																																																																																																
				11	○	○	○																																																																																																																																
				10	○	○	○																																																																																																																																
				9	○	○	○																																																																																																																																
				8	○	○	○																																																																																																																																
				7	○	○	○																																																																																																																																
				6	○	○	○																																																																																																																																
				5	○	○	○																																																																																																																																
				4	○	○	○																																																																																																																																
				3	○	○	○																																																																																																																																
				2	○	○	○																																																																																																																																
1	○	○	○																																																																																																																																				
31	NC	CH1-	CH1+																																																																																																																																				
30	NC	CH2-	CH2+																																																																																																																																				
29	NC	CH3-	CH3+																																																																																																																																				
28	NC	CH4-	CH4+																																																																																																																																				
27	NC	CH5-	CH5+																																																																																																																																				
26	NC	CH6-	CH6+																																																																																																																																				
25	NC	CH7-	CH7+																																																																																																																																				
24	CGND	CH8-	CH8+																																																																																																																																				
23	NC	CH9-	CH9+																																																																																																																																				
22	NC	CH10-	CH10+																																																																																																																																				
21	NC	CH11-	CH11+																																																																																																																																				
20	NC	CH12-	CH12+																																																																																																																																				
19	NC	CH13-	CH13+																																																																																																																																				
18	NC	CH14-	CH14+																																																																																																																																				
17	NC	CH15-	CH15+																																																																																																																																				
16	CGND	CH16-	CH16+																																																																																																																																				
15	NC	CH17-	CH17+																																																																																																																																				
14	NC	CH18-	CH18+																																																																																																																																				
13	NC	CH19-	CH19+																																																																																																																																				
12	NC	CH20-	CH20+																																																																																																																																				
11	NC	CH21-	CH21+																																																																																																																																				
10	NC	CH22-	CH22+																																																																																																																																				
9	NC	CH23-	CH23+																																																																																																																																				
8	OUTPUT	CH24-	CH24+																																																																																																																																				
7	AOREF	CH25-	CH25+																																																																																																																																				
6	GUARD	CH26-	CH26+																																																																																																																																				
5	CGND	CH27-	CH27+																																																																																																																																				
4	DTEMP	CH28-	CH28+																																																																																																																																				
3	MTEMP	CH29-	CH29+																																																																																																																																				
2	CGND	CH30-	CH30+																																																																																																																																				
1	+5V	CH31-	CH31+																																																																																																																																				

Note: NC means no connection.

AO GND	1	2	AO GND
CH0+	3	4	CH0-
	5	6	
	7	8	
	9	10	
	11	12	
	13	14	
	15	16	
	17	18	
OUT REF	19	20	
	21	22	
	23	24	DIG GND
SER DAT IN	25	26	SER DAT OUT
DAQ D*/A	27	28	
SLOT 0 SEL	29	30	
	31	32	
DIG GND	33	34	
	35	36	AI HOLD
SER CLK	37	38	
	39	40	
	41	42	
RSVD	43	44	
	45	46	RSVD
	47	48	
	49	50	

Figure 2. SCXI-1100 Rear Connector Pin Assignments

Specifications

This section contains test specifications for the SCXI-1100 module. The test point value should fall between the upper limit and lower limit values.

Uncalibrated Offset Limit

- Gain1
- Filter.....4 Hz
- Offset±(3 mV + E Series DAQ device offset)

Table 4. SCXI-1100 Filter Specifications

Gain	Range (V)	Test Point (V)	4 Hz Filter		10 kHz Filter	
			Upper Limit (V)	Lower Limit (V)	Upper Limit (V)	Lower Limit (V)
1	10.000	9.5000	9.505015	9.494985	9.505015	9.494985
1	10.000	0.0000	0.000265	-0.000265	0.000265	-0.000265
1	10.000	-9.5000	-9.494985	-9.505015	-9.494985	-9.505015
2	5.000	4.5000	4.506940	4.493060	4.506940	4.493060
2	5.000	0.0000	0.000190	-0.000190	0.000190	-0.000190
2	5.000	-4.5000	-4.493060	-4.506940	-4.493060	-4.506940
5	2.000	1.9000	1.902965	1.897035	1.902965	1.897035
5	2.000	0.0000	0.000115	-0.000115	0.000115	-0.000115
5	2.000	-1.9000	-1.897035	-1.902965	-1.897035	-1.902965
10	1.000	0.9500	0.951510	0.948490	0.951511	0.948489
10	1.000	0.0000	0.000085	-0.000085	0.000086	-0.000086
10	1.000	-0.9500	-0.948490	-0.951510	-0.948489	-0.951511
20	0.500	0.4500	0.450750	0.449250	0.450751	0.449249
20	0.500	0.0000	0.000075	-0.000075	0.000076	-0.000076
20	0.500	-0.4500	-0.449250	-0.450750	-0.449249	-0.450751
50	0.200	0.1900	0.190345	0.189655	0.190346	0.189654
50	0.200	0.0000	0.000060	-0.000060	0.000061	-0.000061
50	0.200	-0.1900	-0.189655	-0.190345	-0.189654	-0.190346
100	0.100	0.0950	0.095198	0.094803	0.095199	0.094802
100	0.100	0.0000	0.000055	-0.000055	0.000056	-0.000056
100	0.100	-0.0950	-0.094803	-0.095198	-0.094802	-0.095199
200	0.050	0.0450	0.045123	0.044878	0.045124	0.044877
200	0.050	0.0000	0.000055	-0.000055	0.000056	-0.000056
200	0.050	-0.0450	-0.044878	-0.045123	-0.044877	-0.045124
500	0.020	0.0190	0.019079	0.018922	0.019080	0.018921
500	0.020	0.0000	0.000050	-0.000050	0.000051	-0.000051

Table 4. SCXI-1100 Filter Specifications (Continued)

Gain	Range (V)	Test Point (V)	4 Hz Filter		10 kHz Filter	
			Upper Limit (V)	Lower Limit (V)	Upper Limit (V)	Lower Limit (V)
500	0.020	-0.0190	-0.018922	-0.019079	-0.018921	-0.019080
1000	0.010	0.0095	0.009560	0.009440	0.009561	0.009439
1000	0.010	0.0000	0.000046	-0.000046	0.000047	-0.000047
1000	0.010	-0.0095	-0.009440	-0.009560	-0.009439	-0.009561
2000	0.005	0.0045	0.004552	0.004448	0.004553	0.004447
2000	0.005	0.0000	0.000046	-0.000046	0.000047	-0.000047
2000	0.005	-0.0045	-0.004448	-0.004552	-0.004447	-0.004553

National Instruments™, NI™, ni.com™, NI-DAQ™, and SCXI™ are trademarks of National Instruments Corporation. Product and company names mentioned herein are trademarks or trade names of their respective companies. For patents covering National Instruments products, refer to the appropriate location: **Help»Patents** in your software, the `patents.txt` file on your CD, or ni.com/patents.

© 2000–2003 National Instruments Corp. All rights reserved.



370155D-01

Sep03